

# MODEL W1854 18" OPEN-END DRUM SANDER



## OWNER'S MANUAL

*(FOR MODELS MANUFACTURED SINCE 07/19)*

Phone: (360) 734-3482 • Online Technical Support: [techsupport@woodstockint.com](mailto:techsupport@woodstockint.com)

COPYRIGHT © APRIL, 2018 BY WOODSTOCK INTERNATIONAL, INC., REVISED FEBRUARY, 2021 (BL)

WARNING: NO PORTION OF THIS MANUAL MAY BE REPRODUCED IN ANY SHAPE OR FORM WITHOUT

THE WRITTEN APPROVAL OF WOODSTOCK INTERNATIONAL, INC.



# **WARNING!**

This manual provides critical safety instructions on the proper setup, operation, maintenance, and service of this machine/tool. Save this document, refer to it often, and use it to instruct other operators.

Failure to read, understand and follow the instructions in this manual may result in fire or serious personal injury—including amputation, electrocution, or death.

The owner of this machine/tool is solely responsible for its safe use. This responsibility includes but is not limited to proper installation in a safe environment, personnel training and usage authorization, proper inspection and maintenance, manual availability and comprehension, application of safety devices, cutting/sanding/grinding tool integrity, and the usage of personal protective equipment.

The manufacturer will not be held liable for injury or property damage from negligence, improper training, machine modifications or misuse.



# **WARNING!**

Some dust created by power sanding, sawing, grinding, drilling, and other construction activities contains chemicals known to the State of California to cause cancer, birth defects or other reproductive harm. Some examples of these chemicals are:

- Lead from lead-based paints.
- Crystalline silica from bricks, cement and other masonry products.
- Arsenic and chromium from chemically-treated lumber.

Your risk from these exposures varies, depending on how often you do this type of work. To reduce your exposure to these chemicals: Work in a well ventilated area, and work with approved safety equipment, such as those dust masks that are specially designed to filter out microscopic particles.

# Contents

<b>INTRODUCTION</b> .....	<b>2</b>	<b>ACCESSORIES</b> .....	<b>28</b>
Woodstock Technical Support .....	2	Sander Accessories .....	28
Machine Specifications .....	3	<b>MAINTENANCE</b> .....	<b>29</b>
Controls & Features .....	5	General .....	29
<b>SAFETY</b> .....	<b>6</b>	Cleaning & Protecting .....	29
Standard Machinery Safety Instructions .....	6	Lubrication .....	30
Additional Safety for Sanders .....	8	Cleaning Sandpaper Belts .....	31
<b>ELECTRICAL</b> .....	<b>9</b>	<b>SERVICE</b> .....	<b>32</b>
Circuit Requirements .....	9	General .....	32
Grounding Requirements .....	10	Replacing V-Belt .....	32
Extension Cords .....	10	Tensioning V-Belt .....	33
<b>SETUP</b> .....	<b>11</b>	Aligning Pulleys .....	34
Unpacking .....	11	Tracking Conveyor Belt .....	35
Items Needed for Setup .....	11	Tensioning Conveyor Belt .....	37
Hardware Recognition Chart .....	12	Replacing Conveyor Belt .....	38
Inventory .....	13	Making Gauge Blocks .....	39
Machine Placement .....	14	Aligning Drum .....	40
Assembly .....	15	Aligning Pressure Rollers .....	41
Dust Collection .....	18	Troubleshooting .....	43
Test Run .....	19	Electrical Safety Instructions .....	45
Recommended Adjustments .....	19	Wiring Diagram .....	46
<b>OPERATIONS</b> .....	<b>20</b>	<b>PARTS</b> .....	<b>47</b>
General .....	20	Main Breakdown .....	47
Stock Inspection & Requirements .....	21	Main Breakdown Cont. ....	48
Setting Depth of Cut .....	22	Labels & Cosmetics .....	51
Sanding .....	23	<b>WARRANTY</b> .....	<b>53</b>
Adjusting Conveyor Feed Rate .....	23		
Sanding Tips .....	24		
Choosing Sandpaper .....	24		
Replacing Sandpaper .....	25		
Changing Sanding Drum Speeds .....	27		

USE THE QUICK GUIDE PAGE LABELS TO SEARCH OUT INFORMATION FAST!





# INTRODUCTION

## Woodstock Technical Support

This machine has been specially designed to provide many years of trouble-free service. Close attention to detail, ruggedly built parts and a rigid quality control program assure safe and reliable operation.

Woodstock International, Inc. is committed to customer satisfaction. Our intent with this manual is to include the basic information for safety, setup, operation, maintenance, and service of this product.

We stand behind our machines! In the event that questions arise about your machine, please contact Woodstock International Technical Support at (360) 734-3482 Ext. 2 or send e-mail to: [techsupport@woodstockint.com](mailto:techsupport@woodstockint.com). Our knowledgeable staff will help you troubleshoot problems and process warranty claims.

If you need the latest edition, you can download it from <http://www.woodstockint.com/manuals>.  
If you have comments about this manual, please contact us at:

**Woodstock International, Inc.**  
**Attn: Technical Documentation Manager**  
**P.O. Box 2309**  
**Bellingham, WA 98227**  
**Email: [manuals@woodstockint.com](mailto:manuals@woodstockint.com)**

# MACHINE SPECIFICATIONS



© Woodstock International, Inc. • Phone: (800) 840-8420 • Web: www.shopfox.biz

## MODEL W1854 18" 1.5 HP OPEN-END DRUM SANDER W/VARIABLE-SPEED FEED

### Product Dimensions

Weight..... 198 lbs.  
 Width (side-to-side) x Depth (front-to-back) x Height..... 35-1/2 x 22-1/2 x 50 in.  
 Footprint (Length x Width)..... 41-1/2 x 22-1/2 in.

### Shipping Dimensions

Type..... Cardboard Box w/Wood Skids  
 Content..... Machine  
 Weight..... 235 lbs.  
 Length x Width x Height..... 25 x 33 x 33 in.  
 Must Ship Upright..... Yes

### Electrical

Power Requirement..... 120V, Single-Phase, 60 Hz  
 Full-Load Current Rating..... 13.92A  
 Minimum Circuit Size..... 20A  
 Connection Type..... Cord & Plug  
 Power Cord Included..... Yes  
 Power Cord Length..... 6 ft.  
 Power Cord Gauge..... 14 AWG  
 Plug Included..... Yes  
 Included Plug Type..... 5-15  
 Switch Type..... Paddle Safety Switch w/Removable Key

### Motors

#### Conveyor Belt

Horsepower..... 1/8 HP  
 Amps..... 0.92A  
 Speed..... 1800 RPM  
 Type..... Universal DC  
 Power Transfer ..... Direct Drive

#### Main

Horsepower..... 1.5 HP  
 Phase..... Single-Phase  
 Amps..... 13A  
 Speed..... 3450 RPM  
 Type..... ODP Capacitor-Start Induction  
 Power Transfer ..... V-Belt Drive  
 Bearings..... Shielded & Permanently Lubricated



**Main Specifications**

**Operation Information**

Number of Sanding Heads.....	1
Maximum Board Width.....	36 in.
Minimum Board Width.....	1 in.
Maximum Board Thickness.....	4-1/2 in.
Minimum Board Thickness.....	1/8 in.
Minimum Board Length.....	6 in.
Sandpaper Speed.....	2600, 3400 FPM
Conveyor Feed Rate.....	0 - 12 FPM
Sandpaper Length.....	89 in.
Sandpaper Width.....	3 in.

**Drum Information**

Infeed Sanding Drum Type.....	Aluminum
Infeed Sanding Drum Size.....	4 in.

**Construction**

Conveyor Belt.....	Sandpaper
Body.....	Steel
Base.....	Steel
Paint Type/Finish.....	Powder Coated

**Other Related Information**

Floor To Table Height.....	35 - 40 in.
Sanding Belt Tension.....	Spring-Loaded
Conveyor Belt Length.....	45 in.
Conveyor Belt Width.....	18 in.
Belt Roller Size.....	1-3/8 in.
Number of Dust Ports.....	1
Dust Port Size.....	4 in.

**Other**

Country of Origin .....	China
Warranty .....	2 Years
Approximate Assembly & Setup Time .....	1-1/2 Hours
Serial Number Location .....	ID Label
Certified by a Nationally Recognized Testing Laboratory (NRTL) .....	Yes

**Features**

- Open-Ended Design Accommodates Workpieces up to 36" Wide
- Spring-Loaded Sanding Belt Tension
- Sandpaper Conveyor Belt
- 4" Dust Port
- Electronic Variable-Speed Conveyor Motor
- 4" Aluminum Sanding Drum
- Durable Powder-Coated Finish
- Stationary Drum Headstock
- Paddle Switch with Removable Key
- Easy Access for Sandpaper Changes

# Controls & Features

Become familiar with the names and locations of the controls and features shown below to better understand the instructions in this manual.



- A. **Conveyor Feed Rate Dial:** Rotate dial clockwise to increase conveyor belt feed rate or counterclockwise to decrease feed rate. Conveyor feed rate ranges from 0-12 FPM.
- B. **ON/OFF Paddle Switch w/Disabling Key:** Turns motor *ON* and *OFF*. Remove yellow key to disable switch.
- C. **Circuit Breaker:** Trips during excessive sanding operation when workload overloads circuit. Press button to reset breaker.
- D. **Table Height Indicator:** Displays approximate distance between sanding drum and conveyor belt.
- E. **Dust Port:** Connects sander to 4" dust collection system.
- F. **Table Elevation Handwheel:** Raises and lowers conveyor table (G). Rotate counterclockwise to lower table; rotate clockwise to raise table. One full rotation moves the table approximately 0.060" (1/16").
- G. **Conveyor Table w/Belt:** Feeds workpiece across conveyor table during sanding operations.
- H. **Belt Access Panel:** Remove panel to change sanding belt pulley positions or make belt adjustments.
- I. **Conveyor Belt Motor:** Controls feed rate of conveyor belt. Use Conveyor Feed Rate Dial (C) to adjust feed speed.

# SAFETY

## For Your Own Safety, Read Manual Before Operating Machine

The purpose of safety symbols is to attract your attention to possible hazardous conditions. This manual uses a series of symbols and signal words intended to convey the level of importance of the safety messages. The progression of symbols is described below. Remember that safety messages by themselves do not eliminate danger and are not a substitute for proper accident prevention measures—this responsibility is ultimately up to the operator!



Indicates an imminently hazardous situation which, if not avoided, **WILL** result in death or serious injury.



Indicates a potentially hazardous situation which, if not avoided, **COULD** result in death or serious injury.



Indicates a potentially hazardous situation which, if not avoided, **MAY** result in minor or moderate injury.

### **NOTICE**

This symbol is used to alert the user to useful information about proper operation of the equipment or a situation that may cause damage to the machinery.

## Standard Machinery Safety Instructions

**OWNER'S MANUAL.** Read and understand this owner's manual **BEFORE** using machine.

**TRAINED OPERATORS ONLY.** Untrained operators have a higher risk of being hurt or killed. Only allow trained/supervised people to use this machine. When machine is not being used, disconnect power, remove switch keys, or lock-out machine to prevent unauthorized use—especially around children. Make workshop kid proof!

**DANGEROUS ENVIRONMENTS.** Do not use machinery in areas that are wet, cluttered, or have poor lighting. Operating machinery in these areas greatly increases the risk of accidents and injury.

**MENTAL ALERTNESS REQUIRED.** Full mental alertness is required for safe operation of machinery. Never operate under the influence of drugs or alcohol, when tired, or when distracted.

**ELECTRICAL EQUIPMENT INJURY RISKS.** You can be shocked, burned, or killed by touching live electrical components or improperly grounded machinery. To reduce this risk, only allow an electrician or qualified service personnel to do electrical installation or repair work, and always disconnect power before accessing or exposing electrical equipment.

**DISCONNECT POWER FIRST.** Always disconnect machine from power supply **BEFORE** making adjustments, changing tooling, or servicing machine. This eliminates the risk of injury from unintended startup or contact with live electrical components.

**EYE PROTECTION.** Always wear ANSI-approved safety glasses or a face shield when operating or observing machinery to reduce the risk of eye injury or blindness from flying particles. Everyday eyeglasses are not approved safety glasses.



**WEARING PROPER APPAREL.** Do not wear clothing, apparel, or jewelry that can become entangled in moving parts. Always tie back or cover long hair. Wear non-slip footwear to avoid accidental slips, which could cause loss of workpiece control.

**HAZARDOUS DUST.** Dust created while using machinery may cause cancer, birth defects, or long-term respiratory damage. Be aware of dust hazards associated with each workpiece material, and always wear a NIOSH-approved respirator to reduce your risk.

**HEARING PROTECTION.** Always wear hearing protection when operating or observing loud machinery. Extended exposure to this noise without hearing protection can cause permanent hearing loss.

**REMOVE ADJUSTING TOOLS.** Tools left on machinery can become dangerous projectiles upon startup. Never leave chuck keys, wrenches, or any other tools on machine. Always verify removal before starting!

**INTENDED USAGE.** Only use machine for its intended purpose—never make modifications without prior approval from Woodstock International. Modifying machine or using it differently than intended will void the warranty and may result in malfunction or mechanical failure that leads to serious personal injury or death!

**AWKWARD POSITIONS.** Keep proper footing and balance at all times when operating machine. Do not overreach! Avoid awkward hand positions that make workpiece control difficult or increase the risk of accidental injury.

**CHILDREN & BYSTANDERS.** Keep children and bystanders at a safe distance from the work area. Stop using machine if they become a distraction.

**GUARDS & COVERS.** Guards and covers reduce accidental contact with moving parts or flying debris—make sure they are properly installed, undamaged, and working correctly.

**FORCING MACHINERY.** Do not force machine. It will do the job safer and better at the rate for which it was designed.

**NEVER STAND ON MACHINE.** Serious injury may occur if machine is tipped or if the cutting tool is unintentionally contacted.

**STABLE MACHINE.** Unexpected movement during operation greatly increases risk of injury or loss of control. Before starting, verify machine is stable and mobile base (if used) is locked.

**USE RECOMMENDED ACCESSORIES.** Consult this owner's manual or the manufacturer for recommended accessories. Using improper accessories will increase risk of serious injury.

**UNATTENDED OPERATION.** To reduce the risk of accidental injury, turn machine **OFF** and ensure all moving parts completely stop before walking away. Never leave machine running while unattended.

**MAINTAIN WITH CARE.** Follow all maintenance instructions and lubrication schedules to keep machine in good working condition. A machine that is improperly maintained could malfunction, leading to serious personal injury or death.

**CHECK DAMAGED PARTS.** Regularly inspect machine for any condition that may affect safe operation. Immediately repair or replace damaged or mis-adjusted parts before operating machine.

**MAINTAIN POWER CORDS.** When disconnecting cord-connected machines from power, grab and pull the plug—NOT the cord. Pulling the cord may damage the wires inside, resulting in a short. Do not handle cord/plug with wet hands. Avoid cord damage by keeping it away from heated surfaces, high traffic areas, harsh chemicals, and wet/damp locations.

**EXPERIENCING DIFFICULTIES.** If at any time you experience difficulties performing the intended operation, stop using the machine! Contact Technical Support at (360) 734-3482.

## Additional Safety for Sanders

Serious injury or death can occur if fingers, clothing, jewelry, or hair get entangled in moving components. Impact injuries can occur from kickback if workpiece is improperly fed into moving sandpaper. Serious pinch injuries can occur from touching in-running nip point between table and sanding surface. Long-term respiratory damage can occur from using sander without proper use of a respirator. To reduce the risk of these hazards, operator and bystanders **MUST** completely heed the hazards and warnings below.

**SANDPAPER DIRECTION.** Feeding workpiece incorrectly can cause it to be thrown from machine, striking operator or bystanders, or causing your hands to slip into the moving sandpaper. To reduce these risks, only sand against direction of sandpaper travel, ensure workpiece is properly supported, and avoid introducing sharp edges into moving sandpaper on leading side of workpiece.

**FEEDING WORKPIECE.** Jamming workpiece into sanding surface could cause it to be grabbed aggressively, pulling hands into sanding surface. Firmly grasp workpiece in both hands and ease it into sandpaper using light pressure.

**AVOIDING ENTANGLEMENT.** Entanglement in moving parts can cause pinching and crushing injuries. Keep all guards in place and closed. **DO NOT** wear loose clothing, gloves, or jewelry, and tie back long hair.

**SANDING DUST.** Sanding creates large amounts of dust that can lead to eye injury or respiratory illness. Reduce risk by wearing approved eye and respiratory protection when using sander. Never operate without adequate dust collection system in place and running. Dust collection is not a substitute for using a respirator.

**WORKPIECE INTEGRITY.** Sanding fragile workpieces can result in loss of control, resulting in abrasion injuries, impact injuries, or damage to sandpaper. Only sand solid workpieces that can withstand power sanding forces. Make sure workpiece shape is properly supported; avoid sanding workpieces without flat bottom surfaces unless some type of jig is used to maintain support and control when sanding force is applied.

**SANDPAPER CONDITION.** Worn or damaged sandpaper can aggressively grab workpiece, resulting in subsequent injuries from operator loss of workpiece control. Always inspect sandpaper before operation and replace if worn or damaged.

**WORKPIECE SUPPORT & HAND PLACEMENT.** Rotating sandpaper can remove a large amount of flesh quickly, and kickback can occur with violent force if workpiece is not properly supported during operation. Always sand with workpiece firmly against table or another support device. Never touch moving sandpaper on purpose.

**IN-RUNNING NIP POINTS.** The gap between moving sandpaper and fixed table/support creates a pinch point for fingers or workpieces; the larger this gap is, the greater the risk of fingers or workpieces getting caught in it. Minimize this risk by adjusting table/support to no more than  $\frac{1}{16}$ " away from sandpaper. For spindle sanders, always use the table insert that fits closest diameter of installed drum.

**MINIMUM STOCK DIMENSION.** Small workpieces can be aggressively pulled from your hands, causing contact with sanding surface. Always use a jig or other holding device when sanding small workpieces, and keep hands and fingers at least 2" away from sanding surface.

**WORKPIECE INSPECTION.** Nails, staples, knots, or other imperfections in workpiece can be dislodged and thrown from sander at a high rate of speed at people, or cause damage to sandpaper or sander. Never sand stock that has embedded foreign objects or questionable imperfections.

# ELECTRICAL

## Circuit Requirements

This machine must be connected to the correct size and type of power supply circuit, or fire or electrical damage may occur. Read through this section to determine if an adequate power supply circuit is available. If a correct circuit is not available, a qualified electrician **MUST** install one before you can connect the machine to power.

A power supply circuit includes all electrical equipment between the breaker box or fuse panel in the building and the machine. The power supply circuit used for this machine must be sized to safely handle the full-load current drawn from the machine for an extended period of time. (If this machine is connected to a circuit protected by fuses, use a time delay fuse marked D.)

### Full-Load Current Rating

The full-load current rating is the amperage a machine draws at 100% of the rated output power. On machines with multiple motors, this is the amperage drawn by the largest motor or sum of all motors and electrical devices that might operate at one time during normal operations.

Full-Load Current Rating at 120V ..... 13.92 Amps

### Circuit Requirements for 120V

This machine is prewired to operate on a power supply circuit that has a verified ground and meets the following requirements:

- Circuit Type ..... 110V/120V, 60 Hz, Single-Phase
- Circuit Size ..... 20 Amps
- Plug/Receptacle ..... NEMA 5-15

**⚠ WARNING**  
 The machine must be properly set up before it is safe to operate. **DO NOT** connect this machine to the power source until instructed to do so later in this manual.

**⚠ WARNING**



Incorrectly wiring or grounding this machine can cause electrocution, fire, or machine damage. To reduce this risk, only an electrician or qualified service personnel should do any required electrical work on this machine.

**NOTICE**

The circuit requirements listed in this manual apply to a dedicated circuit—where only one machine will be running at a time. If this machine will be connected to a shared circuit where multiple machines will be running at the same time, consult with an electrician to ensure that the circuit is properly sized for safe operation.

ELECTRICAL

# Grounding Requirements

This machine **MUST** be grounded. In the event of certain types of malfunctions or breakdowns, grounding provides a path of least resistance for electric current to travel—in order to reduce the risk of electric shock.

Improper connection of the equipment-grounding wire will increase the risk of electric shock. The wire with green insulation (with/without yellow stripes) is the equipment-grounding wire. If repair or replacement of the power cord or plug is necessary, do not connect the equipment-grounding wire to a live (current carrying) terminal.

Check with a qualified electrician or service personnel if you do not understand these grounding requirements, or if you are in doubt about whether the tool is properly grounded. If you ever notice that a cord or plug is damaged or worn, disconnect it from power, and immediately replace it with a new one.

## For 120V Connection

This machine is equipped with a power cord with an equipment-grounding wire and NEMA 5-15 grounding plug (see figure). The plug must only be inserted into a matching receptacle that is properly installed and grounded in accordance with local codes and ordinances.

## Extension Cords

We do not recommend using an extension cord with this machine. Extension cords cause voltage drop, which may damage electrical components and shorten motor life. Voltage drop increases with longer extension cords and smaller gauge sizes (higher gauge numbers indicate smaller sizes).

Any extension cord used with this machine must contain a ground wire, match the required plug and receptacle, and meet the following requirements:

- Minimum Gauge Size at 120V ..... 12 AWG**
- Maximum Length (Shorter is Better) ..... 50 ft.**

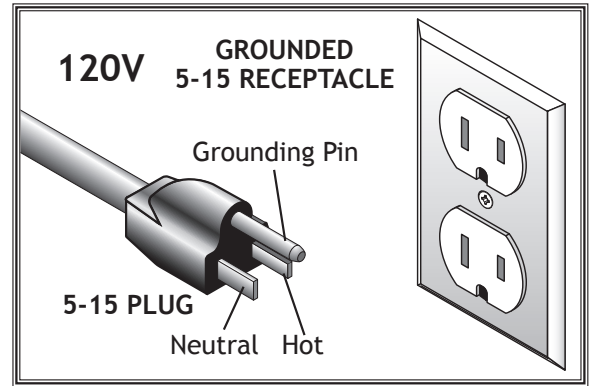
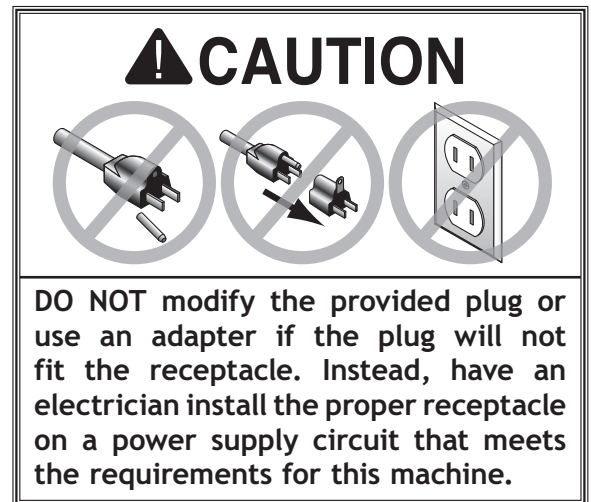

Figure 1. NEMA 5-15 plug & receptacle.



# SETUP

## Unpacking

This machine has been carefully packaged for safe transportation. If you notice the machine has been damaged during shipping, please contact your authorized Shop Fox dealer immediately.

## Items Needed for Setup

The following items are needed, but not included, to set up your machine.

Description	Qty
• Additional People.....	2
• Safety Glasses.....	1 Ea.
• Phillips Head Screwdriver #2 .....	1
• Wood Blocks 2x4.....	3
• Wood Shims.....	As Needed
• Dust Hose 4" .....	Length As Needed
• Hose Clamps 4" .....	2



**!WARNING**

This machine presents serious injury hazards to untrained users. Read through this entire manual to become familiar with the controls and operations before starting the machine!



**!WARNING**

Wear safety glasses during entire setup process!



**!WARNING**

USE helpers or power lifting equipment to lift this machine. Otherwise, serious personal injury may occur.

SETUP

# Hardware Recognition Chart

USE THIS CHART TO IDENTIFY HARDWARE DURING THE INVENTORY/ASSEMBLY PROCESS.

SETUP

MEASURE BOLT DIAMETER BY PLACING INSIDE CIRCLE  
LINES ARE 1/16" INCH APART

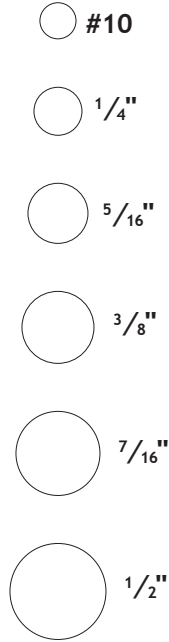
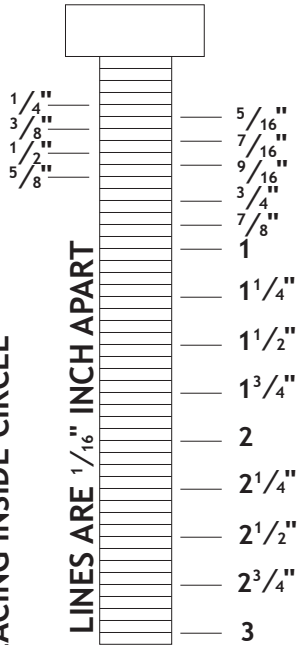

WASHERS ARE MEASURED BY THE INSIDE DIAMETER

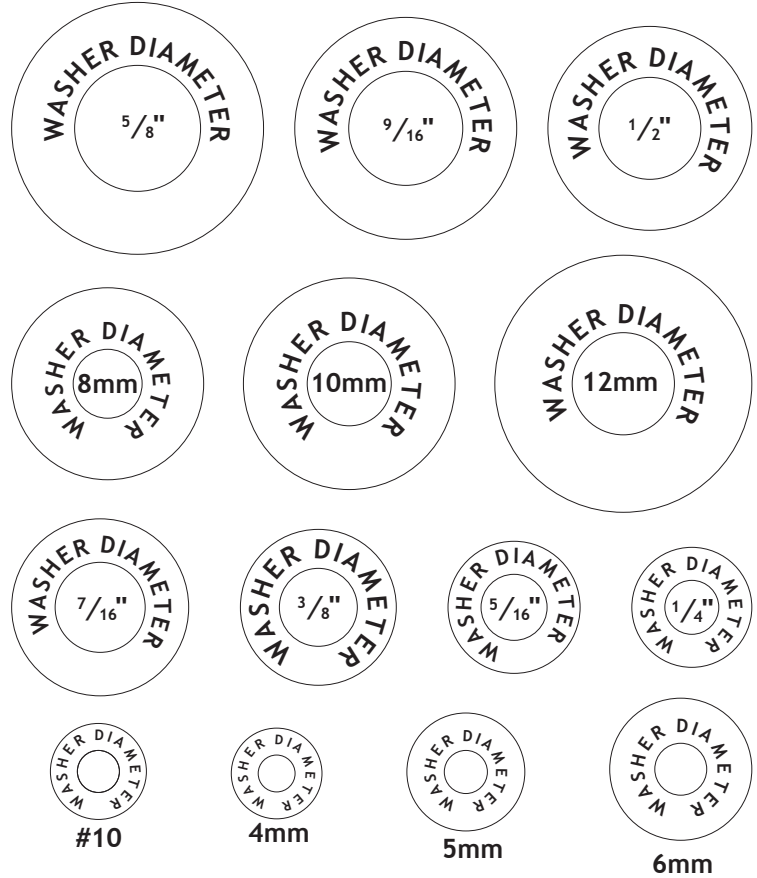

MEASURE BOLT DIAMETER BY PLACING INSIDE CIRCLE  
LINES ARE 1MM APART

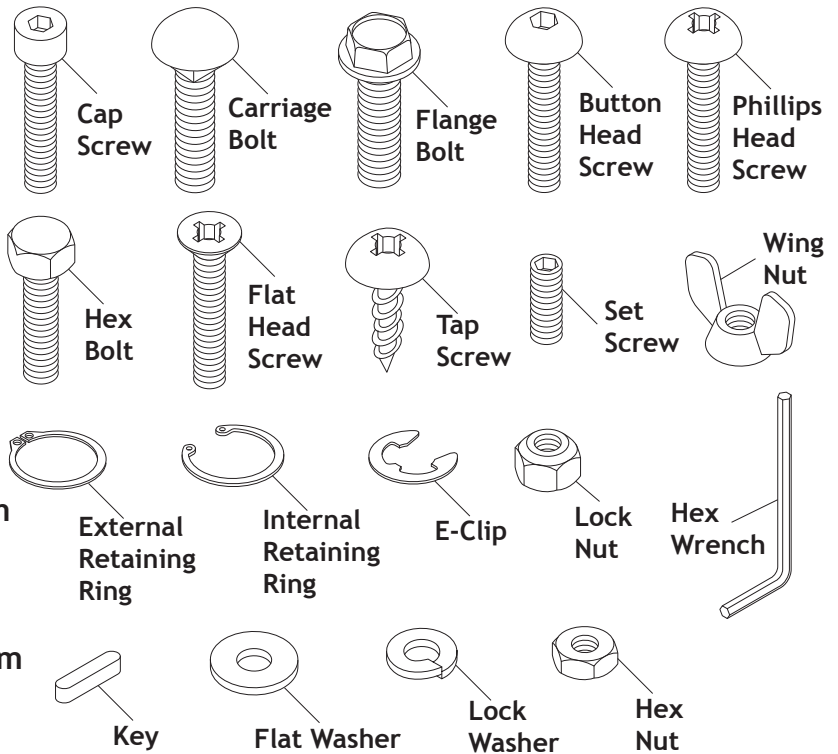
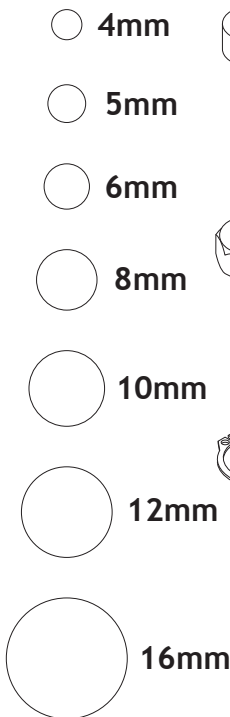
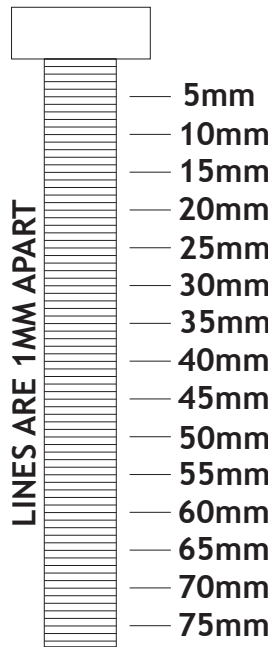

# Inventory

The following is a list of items shipped with your machine. Before beginning setup, lay these items out and inventory them.

**Note:** *If you cannot find an item on this list, carefully check around/inside the machine and packaging materials. Often, these items get lost in packaging materials while unpacking or they are pre-installed at the factory.*

Box Contents (Figure 2)	Qty
A. Main Sander Unit (Not Shown) .....	1
B. Top Long Brackets .....	2
C. Top Short Brackets .....	2
D. Bottom Short Brackets.....	2
E. Bottom Long Brackets .....	2
F. Stand Legs .....	4
G. Handwheel w/Handle.....	1
H. Hardware and Tools (Not Shown)	
– Hex Bolts M8-1.25 x 20 .....	4
– Hex Nuts M8-1.25 .....	4
– Flat Washers 8mm .....	8
– Carriage Bolts M8-1.25 x 15.....	24
– Flange Nuts M8-1.25 .....	24
– Combination Wrench 8/12mm.....	1
– Hex Wrenches 4, 5, 6mm .....	1 Ea.

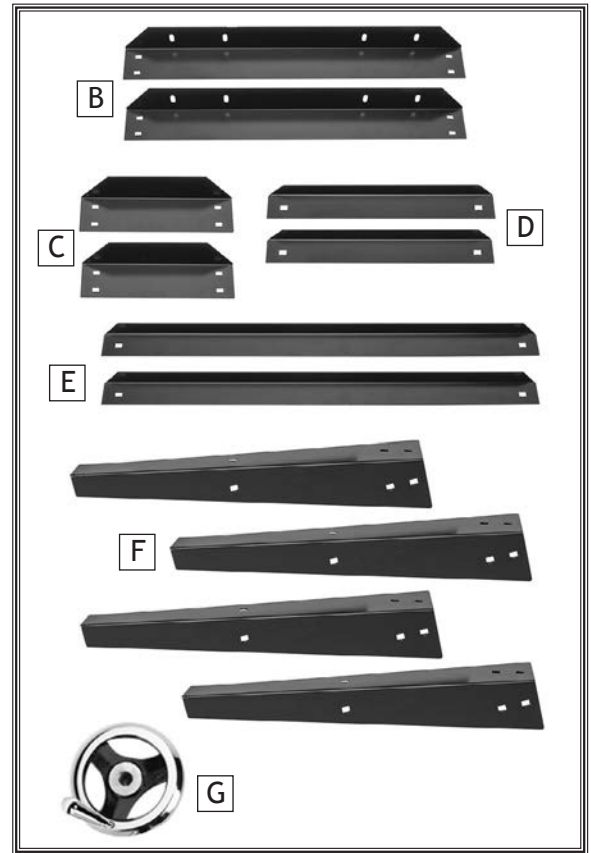

Figure 2. Additional box contents.

# Machine Placement

## Weight Load

Refer to the **Machine Specifications** for the weight of your machine. Make sure that the surface upon which the machine is placed will bear the weight of the machine, additional equipment that may be installed on the machine, and the heaviest workpiece that will be used. Additionally, consider the weight of the operator and any dynamic loading that may occur when operating the machine.

## Space Allocation

Consider the largest size of workpiece that will be processed through this machine and provide enough space around the machine for adequate operator material handling or the installation of auxiliary equipment. With permanent installations, leave enough space around the machine to open or remove doors/covers as required by the maintenance and service described in this manual. **See below for required space allocation.**

## Physical Environment

The physical environment where your machine is operated is important for safe operation and the longevity of its components. For best results, operate this machine in a dry environment that is free from excessive moisture, hazardous chemicals, airborne abrasives, or extreme conditions. Extreme conditions for this type of machinery are generally those where the ambient temperature range exceeds 41°-104°F; the relative humidity range exceeds 20-95% (non-condensing); or the environment is subject to vibration, shocks, or bumps.

## Electrical Installation

Place this machine near an existing power source. Make sure all power cords are protected from traffic, material handling, moisture, chemicals, or other hazards. Make sure to leave access to a means of disconnecting the power source or engaging a lockout/tagout device.

## Lighting

Lighting around the machine must be adequate enough that operations can be performed safely. Shadows, glare, or strobe effects that may distract or impede the operator must be eliminated.

SETUP

	<p><b>CAUTION</b></p> <p>Children or untrained people may be seriously injured by this machine. Only install in an access restricted location.</p>
--	--

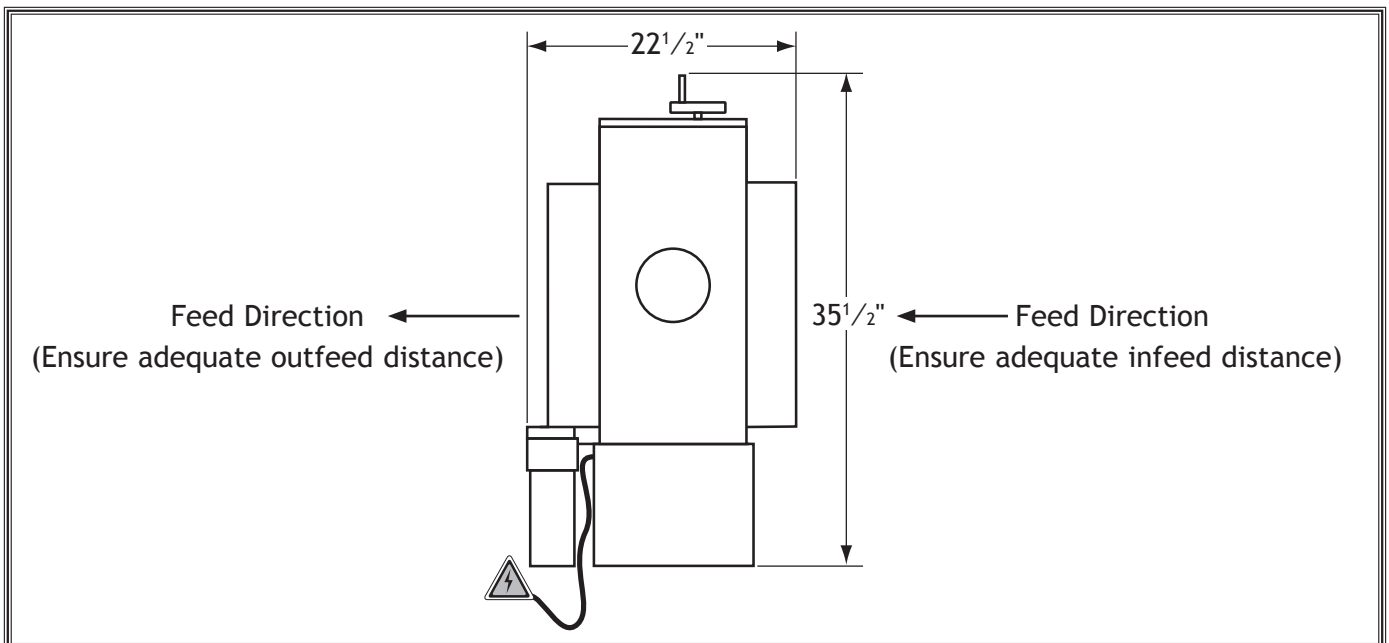

Figure 3. Working clearances.



# Assembly

Before beginning the assembly process, refer to **Items Needed for Setup** and gather everything you need. Ensure all parts have been properly cleaned of any heavy-duty rust-preventative applied at the factory (if applicable). Be sure to complete all steps in the assembly procedure prior to performing the **Test Run** or connecting

**Note:** We recommend assembling the stand upside down. To make it easier, have an assistant hold the pieces while you assemble the stand.

## NOTICE

Do not final-tighten stand bolts until all stand components have been assembled. It will help with aligning and leveling stand later in assembly steps.

To assemble machine, do these steps:

1. Move sander crate to an appropriate location, as described in **Machine Placement** on previous page.
2. Mount a top and bottom long bracket to a stand leg and secure by hand with (2) M8-1.25 x 15 carriage bolts and (2) M8-1.25 flange nuts, as shown in **Figure 4**.
3. Secure a second leg to top and bottom long brackets with (2) M8-1.25 x 15 carriage bolts and flange nuts, as shown in **Figure 5**.
4. Repeat **Steps 2-3** with remaining components to build remaining stand leg assembly.
5. Mount top and bottom short brackets to stand leg assembly with (2) M8-1.25 x 15 carriage bolts and (2) M8-1.25 flange nuts, as shown in **Figure 6**.
6. Assemble remaining stand components, as shown in **Figure 7**, with remaining hardware.

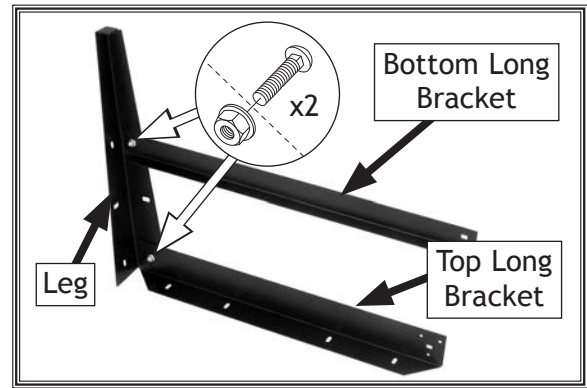

Figure 4. Top and bottom long brackets secured to a stand leg.

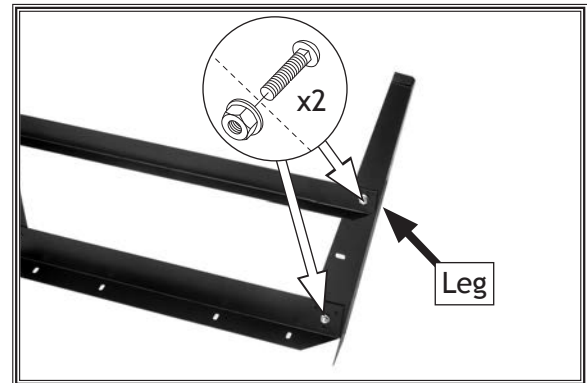

Figure 5. A completed stand leg assembly.

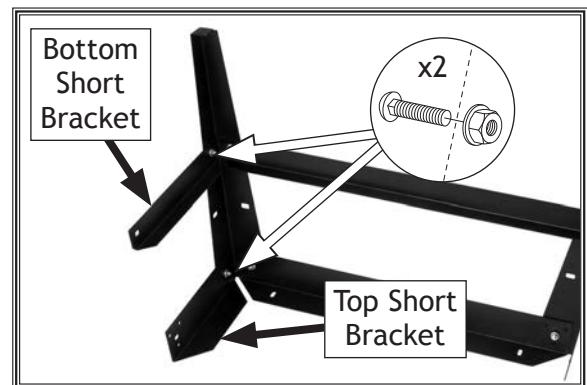

Figure 6. Top and bottom short brackets secured to stand leg assembly.

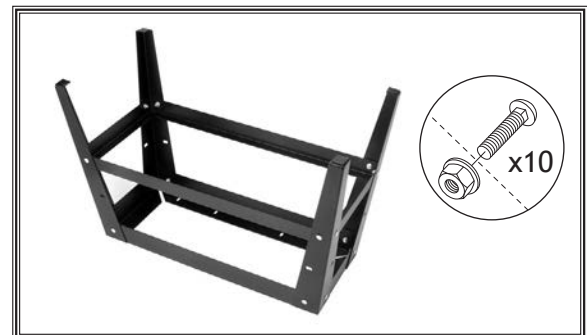

Figure 7. Completed stand assembly.

SETUP

7. Turn stand upright and adjust it so legs are evenly positioned, then tighten all stand fasteners.
8. Make sure sander is still resting on shipping pallet.
9. Place pallet and stand near appropriate location (once sander is mounted to stand it will be difficult to move).
10. With help of an assistant, tilt sander back so side with belt access panel faces pallet. Move left bottom edge of sander forward, as shown in **Figure 8**.

**Note:** The base should be even with or stick out from the edge of the pallet to properly install stand assembly.



**! WARNING**  
 USE helpers or power lifting equipment to lift this machine. Otherwise, serious personal injury may occur.

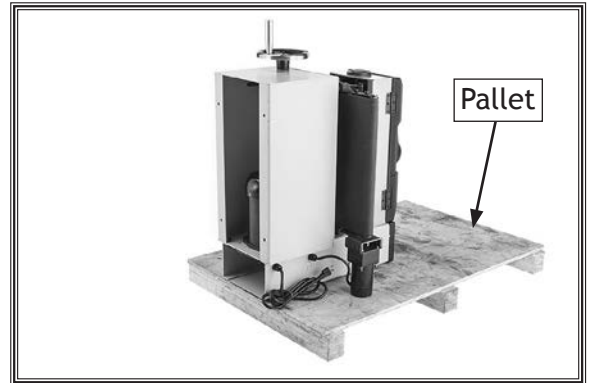

**Figure 8.** Sander tipped back on pallet against belt access panel.

11. Lay stand assembly on blocks, as shown in **Figure 9**.

**Tip:** Place two stacks of blocks the same height as the pallet and about 15 inches apart on the floor near the sander base, and lay the stand assembly on the blocks, as shown in **Figure 9**.

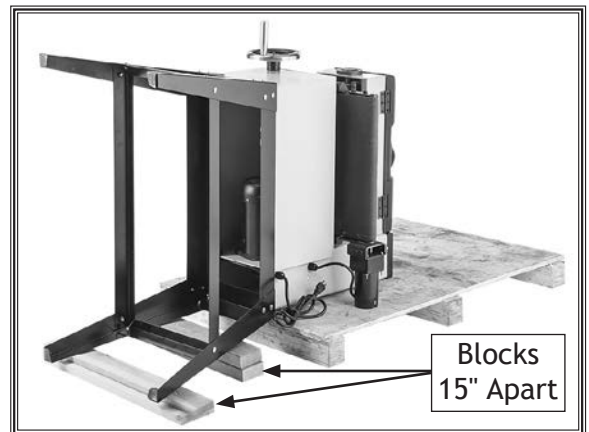

**Figure 9.** Stand resting on blocks.

12. Secure stand to sander with (4) M8-1.25 x 20 hex bolts, (8) 8mm flat washers, and (4) M8-1.25 hex nuts, as shown in **Figure 10**.
13. Lift up on stand and remove blocks.

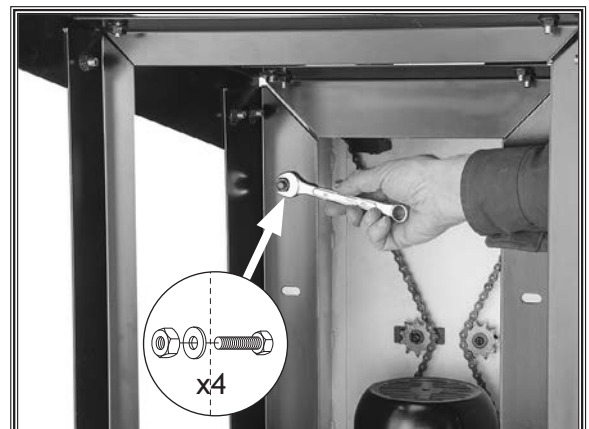

**Figure 10.** Mounting sander to stand.

14. With help from an assistant, carefully tilt sander upright, as shown in **Figure 11**, so rear legs touch floor.

**⚠ CAUTION**

If the legs start to slide when tilting sander upright, you **MUST** have a third person hold the stand to keep it from sliding to avoid personal injury or machine damage!



Figure 11. Tilting sander upright.

15. Install table elevation handwheel. Slide handwheel slots over shaft pin, as shown in **Figure 12**. Secure with pre-installed M6-1 x 35 cap screw and 6mm fender washer.

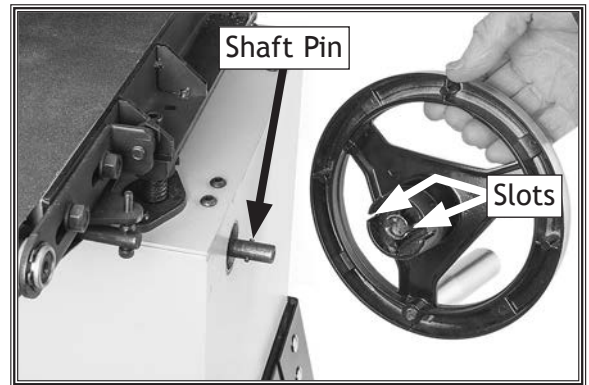

Figure 12. Installing handwheel.

SETUP

# Dust Collection

Recommended CFM at Dust Port: ..... 400 CFM

You may attach the Model W1854 drum sander to a dust-collection system; we recommend using a system that can collect a minimum of 400 CFM AT THE DUST PORT.

Do not confuse this CFM recommendation with the rating of the dust collector. To determine the CFM at the dust port, you must consider these variables: (1) CFM rating of the dust collector, (2) hose type and length between the dust collector and the machine, (3) number of branches or wyes, and (4) amount of other open lines throughout the system. Explaining how to calculate these variables is beyond the scope of this manual. Consult an expert or purchase a good dust collection “how-to” book.

When the dust collection is working properly, a fine layer of dust may be present on your stock as it comes out of the sander. This is a normal characteristic of all drum sanders.

Items Needed	Qty
Dust-Collection System .....	1
Dust Hose 4" .....	1
Hose Clamps 4" .....	2

To connect dust port to a dust collector, do these steps:

1. Fit 4" dust-collection hose to dust port and secure in place with hose clamp (see **Figure 13**).
2. Tug hose to make sure it does not come off.

**Note:** A tight fit is necessary for proper performance.

**⚠ CAUTION**

This machine creates substantial amounts of dust during operation. Breathing airborne dust on a regular basis can result in permanent respiratory illness. Reduce your risk by wearing a respirator and capturing the dust with a dust-collection system.



**Figure 13.** Dust port connected to dust-collection system.

**SETUP**

## Test Run

Once assembly is complete, test run the machine to ensure it is properly connected to power and safety components are functioning properly.

If you find an unusual problem during the test run, immediately stop the machine, disconnect it from power, and fix the problem **BEFORE** operating the machine again. The **Troubleshooting** table in the **SERVICE** section of this manual can help.

The test run consists of verifying: 1) The motor powers up and runs correctly, and 2) the safety disabling mechanism on the switch works correctly.

To test run the machine, do these steps:

1. Clear all setup tools away from machine.
2. Connect machine to power supply.
3. Turn machine **ON**, verify motor operation, then turn machine **OFF**.

The motor should run smoothly and without unusual noises.

4. Remove switch disabling key (see **Figure 14**).
5. Try to start machine with paddle switch. Machine should not start.
  - If machine *does not* start, the switch disabling feature is working as designed.
  - If machine *does* start, immediately stop the machine. The switch disabling feature is not working correctly. This safety feature must work properly before proceeding with regular operations. Call Tech Support for help.

## Recommended Adjustments

For your convenience, the adjustments listed below have been performed at the factory and no further setup is required to operate your machine.

However, because of the many variables involved with shipping, some of these adjustments may need to be repeated to ensure optimum results.

**⚠ WARNING**

Serious injury or death can result from using this machine **BEFORE** understanding its controls and related safety information. **DO NOT** operate, or allow others to operate, machine until the information is understood.

**⚠ WARNING**

**DO NOT** start machine until all preceding setup instructions have been performed. Operating an improperly set up machine may result in malfunction or unexpected results that can lead to serious injury, death, or machine/property damage.

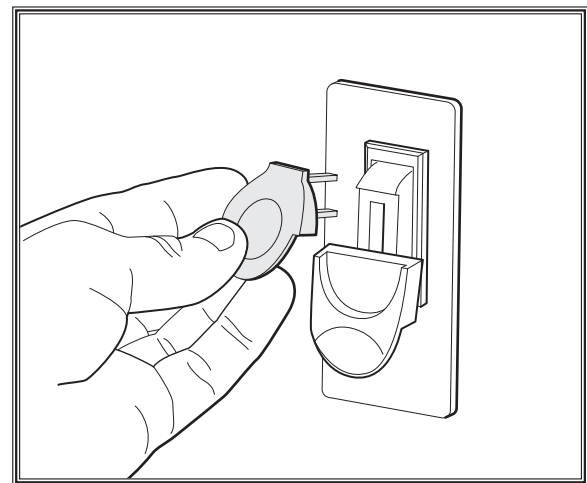

**Figure 14.** Removing switch key from paddle switch.

- **Tensioning V-Belt** (see **Page 33**). Perform after the first 16 hours.
- **Tracking & Tensioning Conveyor Belt** (see **Pages 35 & 37**).
- **Making Gauge Blocks** (see **Page 39**).

**SETUP**

# OPERATIONS

## General

The purpose of this overview is to provide the novice machine operator with a basic understanding of how the machine is used during operation, so the machine controls/components discussed later in this manual are easier to understand.

Due to the generic nature of this overview, it is **not** intended to be an instructional guide. To learn more about specific operations, read this entire manual, seek additional training from experienced machine operators, and do additional research outside of this manual by reading "how-to" books, trade magazines, or websites.

To complete a typical sanding operation, the operator does the following:

1. Examines workpiece to verify it is suitable for sanding and to determine which sanding belt grit size to use.
2. Installs and tensions sanding belt.
3. Verifies workpiece will have necessary outfeed clearance and support. If workpiece is wider than conveyor table, operator supports workpiece full width.
4. Adjusts table height to approximate workpiece thickness.
5. Puts on required safety glasses and respirator.
6. Ensures dust collection is connected to dust port.
7. Turns motor **ON**.
8. Feeds workpiece into sander by placing front end on infeed side of conveyor table and supporting back end until workpiece engages with pressure rollers.
 

*Note: During initial pass with a new workpiece, operator adjusts table height as necessary so workpiece only makes light contact with sanding belt and does not overload sander.*
9. Receives workpiece from outfeed side of conveyor table. If workpiece is wider than conveyor table, operator rotates workpiece 180° and feeds workpiece back through sander.

**! WARNING**



To reduce your risk of serious injury or damage to the machine, read this entire manual **BEFORE** using machine.

**! WARNING**

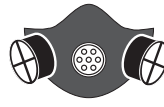
To reduce the risk of eye injury and long-term respiratory damage, always wear safety glasses and a respirator while operating this machine.

**NOTICE**

If you are an inexperienced operator, we strongly recommend that you read books or trade articles, or seek training from an experienced operator of this type of machinery before performing unfamiliar operations. Above all, safety must come first!

10. Raises height of conveyor table a small amount ( $\frac{1}{4}$  of a full rotation of handwheel), then repeats the feeding process of workpiece through sander.
11. Disconnects power to change sandpaper to a finer grit, as needed.
12. Repeats **Steps 8-11** as needed, turns sander **OFF**, and disconnects it from power when complete.

# Stock Inspection & Requirements

Some workpieces are not safe to sand, or they may require further preparation before they can be safely sanded without increasing risk of injury to the operator or damaging the sanding belt or the sander.

**Before sanding, inspect all workpieces for the following:**

- **Material Type:** This machine is intended for sanding natural and man-made wood products, and laminate-covered wood products. This machine is NOT designed to sand metal, glass, stone, tile, plastics, drywall, cementious backer board, etc.

Sanding improper materials increases the risk of respiratory harm to the operator and bystanders due to the especially fine dust inherently created by all types of sanding operations—even if a dust collector is used. Additionally, the life of the machine and sanding belts will be greatly reduced (or immediately damaged) from sanding improper materials or from exposure to the fine dust created when doing so.

- **Foreign Objects:** Nails, staples, dirt, rocks and other foreign objects are often embedded in wood. While sanding, these objects can become dislodged and tear the sanding belt. Always visually inspect your workpiece for these items. If they can't be removed, DO NOT sand the workpiece.
- **Wet or "Green" Stock:** Sanding wood with a moisture content over 20% causes unnecessary clogging and wear on the sanding belt, increases the risk of kickback, and yields poor results.
- **Excessive Warping:** Workpieces with excessive cupping, bowing, or twisting are dangerous to sand because they are unstable and often unpredictable when being sanded. DO NOT use workpieces with these characteristics!

# Setting Depth of Cut

The optimum depth of cut will vary based on the type of wood, feed rate, and sandpaper grit. Attempts to remove too much material can cause the circuit breaker to trip, jamming, wood burning, rapid paper wear or tearing, poor finish, and belt slippage.

To set depth of cut, do these steps:

1. Rotate table elevation handwheel (see **Figure 15**) until conveyor table is well below sanding drum, then raise table, allowing a gap between workpiece and sanding drum.

*Note: When adjusting table to sand a thicker workpiece, lower and then raise table to remove backlash from adjustment mechanism.*

2. Turn machine **ON** and feed workpiece into sander. **SLOWLY** raise conveyor table until workpiece makes light contact with sanding drum. This is the correct height to begin sanding workpiece.
3. After initial pass, turn handwheel up to  $\frac{1}{4}$  turn ( $\frac{1}{64}$ " or 0.4mm)—maximum depth for most sanding conditions.

*Note: Each full turn of the table elevation handwheel raises the conveyor table approximately 0.060" ( $\frac{1}{16}$ " ) or 1.5mm.*



**Figure 15.** Table elevation handwheel.



# Adjusting Conveyor Feed Rate

The conveyor feed rate dial (see **Figure 16**) allows you to set the conveyor feed rate from 0-12 FPM. The correct speed to use depends on the type of stock you are using (hardwood vs. softwood) and the stage of finish with that workpiece.

As a general rule, a slower feed rate will sand the surface smoother, but runs the risk of burning the wood; a faster feed rate will remove material faster, but runs the risk of overloading the motor or damaging the sandpaper.

Use trial-and-error to determine the best settings for your specific applications.

To adjust conveyor feed rate, do these steps:

1. Turn **ON** conveyor belt.
2. Rotate conveyor feed rate dial (see **Figure 16**) clockwise to increase the feed speed or counterclockwise to decrease conveyor feed speed.

**NOTICE**

**DO NOT** adjust variable-speed knob when the conveyor motor is **OFF**. Damage to the V-belt and the adjusting mechanism can result.



**Figure 16.** Location of conveyor feed rate dial.

# Sanding

To sand a workpiece, do these steps:

1. Adjust table height according to instructions in **Setting Depth of Cut** on **Page 22**.
2. Start dust collector, if connected, before turning sander **ON**.
3. Feed workpiece through sander. Retrieve workpiece by standing at the side—not at outfeed end.
4. Run wide stock through two or three times without adjusting the table height. Turn stock 180° between passes to ensure an evenly sanded surface.

**! WARNING**

**DO NOT** sand more than one board at a time. Minor variations in thickness can cause one board to be propelled by the rapidly spinning sanding drum and ejected from the machine. **NEVER** stand directly in front of the outfeed area of the machine. Failure to do so could result in severe personal injury.

**NOTICE**

Overloading the motor or pushing the sander to failure weakens the electrical system. Repeatedly doing so is abuse to the machine that will cause motor, capacitor, or thermal breaker damage, which is not covered by the warranty.

## Sanding Tips

- Replace coarse grit sandpaper with a finer grit to achieve a smoother finish.
- Raise the table a maximum 1/4 turn of the handwheel until the workpiece is the desired thickness.
- Reduce snipe when sanding more than one board of the same thickness by feeding them into the sander with the front end of the second board touching the back end of the first board.
- Feed boards into the sander at different places on the conveyor to maximize sandpaper life and prevent uneven conveyor belt wear.
- DO NOT sand boards less than 6" long or less than 1/8" thick to prevent damage to the workpiece and the drum sander.
- Extend the life of the sandpaper by regularly using a PRO-STIK® cleaning pad (see Page 28).
- When sanding workpieces with irregular surfaces, such as cabinet doors, take very light sanding passes to prevent gouges. When the drum moves from sanding a wide surface to sanding a narrow surface, the load on the motor will be reduced, and the drum will speed up, causing a gouge.
- DO NOT edge-sand boards. This can cause boards to kick back, causing serious personal injury. Edge-sanding boards also can cause damage to the conveyor belt and sandpaper.
- When sanding workpieces with a bow or crown, place the high point up (prevents the workpiece from rocking) and take very light passes.
- Feed the workpiece at an angle to maximize stock removal and sandpaper effectiveness, but feed the workpiece straight to reduce sandpaper grit scratches for the finish passes.

## Choosing Sandpaper

There are many types of sanding belts to choose from. We recommend aluminum oxide for general workshop environments. Below is a chart that groups abrasives into different classes, and shows which grits fall into each class.

Grit	Class	Usage
36	Extra Coarse	Rough-sawn boards, thickness sanding, and glue removal.
60	Coarse	Thickness sanding and glue removal.
80-100	Medium	Removing planer marks and initial finish sanding.
120-220	Fine	Finish sanding.

The general rule of thumb is to sand a workpiece with progressively higher grit numbers, with no one grit increase of more than 50. Avoid skipping grits; the larger the grit increase, the harder it will be to remove the scratches from the previous grit.

Ultimately, the type of wood you use and your stage of finish will determine the best grit types to install on your sander.

# Replacing Sandpaper

The Model W1854 is designed for 3" wide sandpaper rolls. Turn to SECTION 5: ACCESSORIES on Page 28 for grit selection and model numbers.

Items Needed	Qty
Flat Head Screwdriver .....	1
Hex Wrench 4mm .....	1
Hex Wrench 5mm .....	1
Carton Cutter or Utility Knife.....	1

To replace sandpaper, do these steps:

1. DISCONNECT MACHINE FROM POWER!
2. Open top cover and loosen cap screw on right spring-loaded clamp, as shown in Figure 17.
3. Remove sandpaper from clamp. Use a flat head screwdriver, if necessary, to loosen clamp to free sandpaper.
4. Rotate drum to carefully remove sandpaper strip from most of the drum but the end.

**Note:** Take care not to rip or tear the old sandpaper, so you can use it as a template when cutting out the replacement sandpaper strip. This is easier than using the drawing shown in Figure 18.

5. Loosen cap screw on left clamp and fully remove sandpaper strip.
6. Use old sandpaper strip as a pattern, if at all possible. Otherwise, use pattern in Figure 18 to cut a new piece of sandpaper to the necessary shape. After cutting the 12" angled sides, measure 2" along same sides and cut off ends with a knife.
7. Insert corner of new sandpaper into left clamp and tighten cap screw, as shown in Figure 19.

**Note:** The angled side of the sandpaper must be flush with the left drum edge. If the sandpaper overlaps the edge, you may have difficulty closing the cover.

8. Wrap sandpaper around drum (see Figure 20), ensuring there are no bubbles or overlapping edges.

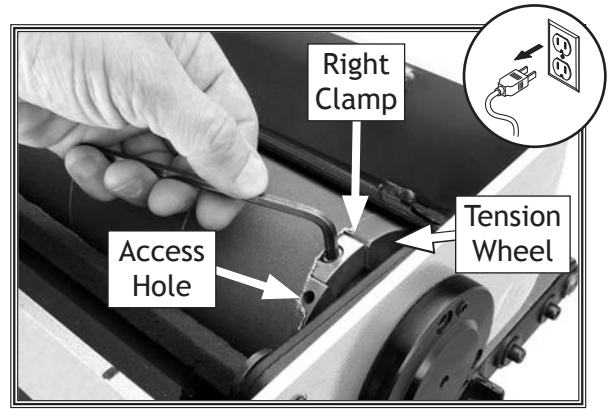

Figure 17. Loosening cap screw on right spring-loaded clamp.

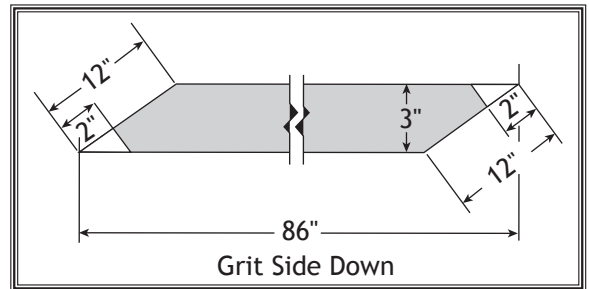

Figure 18. Sandpaper pattern for drum.

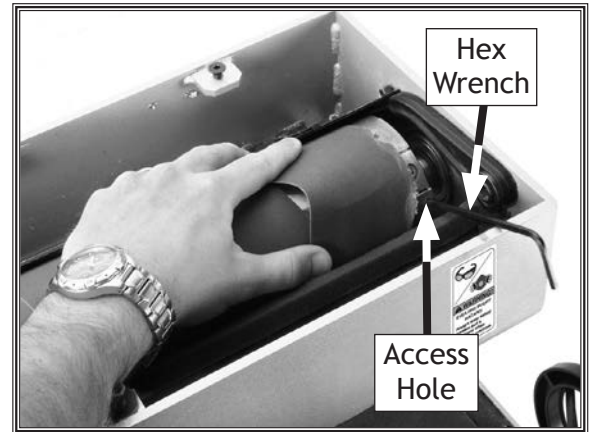

Figure 19. Securing sandpaper in left clamp.

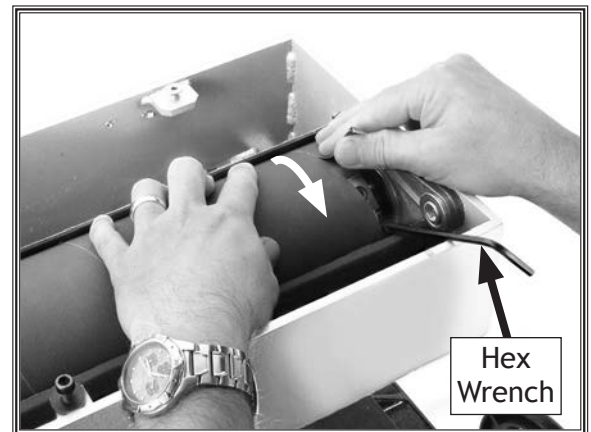

Figure 20. Wrapping sandpaper around drum.

9. When sandpaper reaches right side of drum, move sandpaper out of the way with a 4mm hex wrench and place it into access hole.
10. Rotate drum toward you so hex wrench rests against frame, as shown in **Figure 21**.
11. Firmly hold down sandpaper with both hands, rotate drum toward you, then wrap end of sandpaper over top of the drum (see **Figure 22**).
12. Place end of sandpaper into clamp, secure it, and remove hex wrench from access hole. Sandpaper should seat flat against roller and not overlap at any point.
  - If the sandpaper does not fit into the right clamp, you may have inserted sandpaper too deeply into left clamp. Also, check to make sure the length, width, and angled cuts match the pattern in **Figure 18** on **Page 25**. Make adjustments to sandpaper if necessary.
  - If sandpaper completely covers access hole, you may have placed too little sandpaper into left clamp. Unwrap sandpaper and repeat **Steps 7-12**.
13. In either case, re-install sandpaper, repeat **Steps 7-12**, and continue adjusting paper until it fits into clamp.
14. When finished, reconnect dust-collection system.



**Figure 21.** Hex wrench inserted into access hole on right tension wheel.



**Figure 22.** Wrapping sandpaper over tension wheel.

# Changing Sanding Drum Speeds

This machine features two different sanding speeds, which are controlled by belt position on the pulleys (see Figure 23).

**IMPORTANT:** Proper belt tension is important for optimum power transmission. Any time pulley adjustments are made, be sure to re-tension the belt.

Items Needed	Qty
Hex Wrenches 4, 8mm .....	1 Ea.

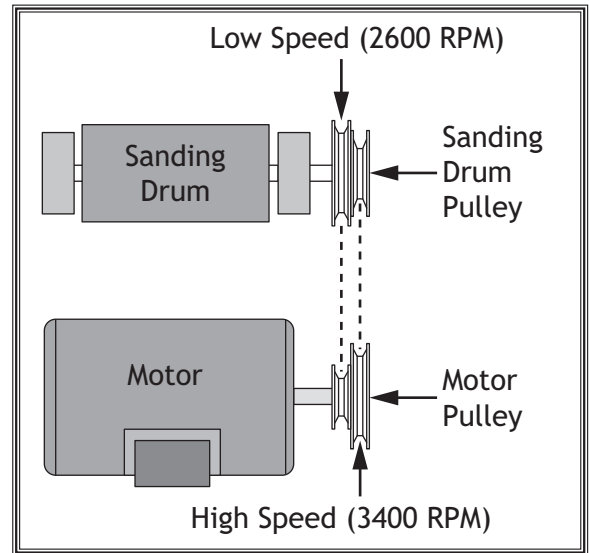

Figure 23. Pulley speed settings.

To adjust V-belt location, do these steps:

1. DISCONNECT MACHINE FROM POWER!
2. Remove pulley cover.
3. Loosen motor mount cap screws shown in Figure 24, and lift motor pulley to de-tension belt.
4. Tighten motor mount cap screws to keep motor de-tensioned during belt change.
5. Roll V-belt onto correct pulley for sanding operation, and follow steps outlined in **Tensioning V-Belt** on Page 33 to properly tension belt before operation.

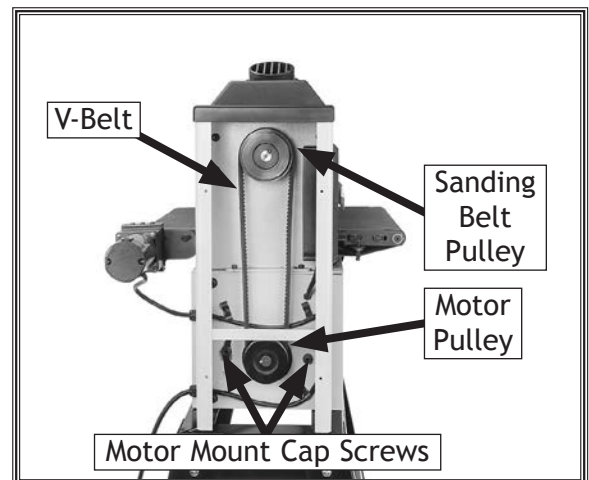

Figure 24. Belt-drive system.

# ACCESSORIES

## Sander Accessories

The following sanding accessories may be available through your local Woodstock International Inc. Dealer. If you do not have a dealer in your area, these products are also available through online dealers. Please call or e-mail Woodstock International Inc. Customer Service to get a current listing of dealers at: 1-800-840-8420 or at [sales@woodstockint.com](mailto:sales@woodstockint.com).

### Aluminum Oxide Sanding Rolls 3" x 10'

- D1207—60-Grit:** Use for thickness sanding and glue removal.
- D1208—80-Grit:** Use to remove planer marks and initial sanding.
- D1209—100-Grit:** Use to remove planer marks and initial sanding.
- D1210—120-Grit:** Use for finish sanding.
- D1211—150-Grit:** Use for finish sanding.
- D1212—180-Grit:** Use for finish sanding.
- D1213—220-Grit:** Use for finish sanding.



The Shop Fox **D3003 PRO-STIK® Cleaning Pads** are the perfect accessory for drum sanders. Simply set the feed belt table to height and feed the 15" x 20" x 3/4" pad through to "unload" a dirty sanding belt. Regular cleaning greatly increases the lifespan of sanding belts.



The Shop Fox **W1844 Wall-Mount Dust Collector with Canister Filter** is an excellent point-of-use dust collector that can be used next to the machine with only a small amount of ducting. Specifications: 537 CFM, 7.2" static pressure, 1.5-cubic-foot maximum material collection capacity, and 1-micron filter. Motor is 1HP, 120V/240V, 7A/3.5A.



The Shop Fox **D2271 19" x 65" Heavy-Duty Roller Table** is a versatile performer wherever you need extra workpiece support. Features all-steel welded construction and measures 19" wide x 65" long. Comes with 9 ball bearing rollers and has four independently adjustable legs for any leveling requirement. Adjustable in height from 26<sup>3</sup>/<sub>8</sub>" to 44<sup>1</sup>/<sub>8</sub>". 78 lbs. 1,000 lb. capacity.



# MAINTENANCE

## General

For optimum performance from your machine, follow this maintenance schedule and refer to any specific instructions given in this section.

### Ongoing:

To maintain a low risk of injury and proper machine operation, if you ever observe any of the items below, shut down the machine immediately and fix the problem before continuing operations:

- Loose mounting bolts.
- Damaged sanding belt.
- Worn switch.
- Worn or damaged cords or plugs.
- Damaged V-belt.
- Any other unsafe condition.
- Clean/vacuum dust buildup from inside cabinet and off of the motor.

### Daily:

- Oil the conveyor belt roller and drive bushings.

### Every 6 Months:

- Lubricate table lift screws, chain, and helical gears.

## Cleaning & Protecting

Cleaning the Model W1854 is relatively easy. Vacuum excess sawdust, and wipe off the remaining dust with a dry cloth.

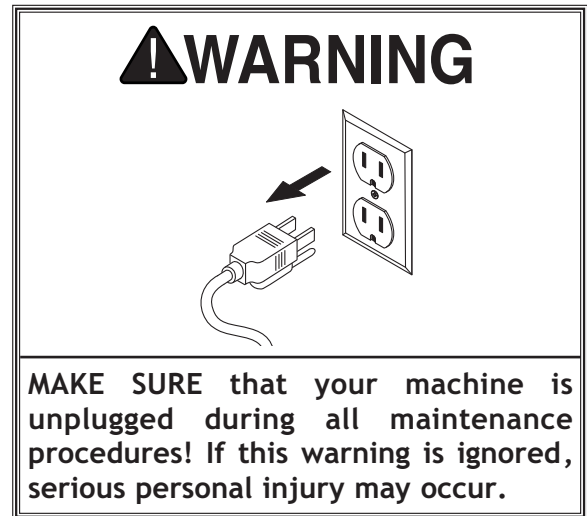

# Lubrication

The feed belt bushings should be lubricated daily with ISO 32 Multi-Function Machine Oil. The bearings do not need lubrication.

Avoid using excess lubrication. Too much lubricant attracts sawdust and will clog the belt bushings.

## Bushings

Oil Type.....	ISO 32 Machine Oil
Oil Amount .....	As Needed
Check/Add Frequency.....	Daily

Oil the drive bushings on each end of the conveyor belt rollers (see **Figure 25**). Wipe off excess oil.

## Table Lift Screws, Chain, & Helical Gears

Oil Type.....	NLGI#2 or Equivalent
Oil Amount .....	As Needed
Check/Add Frequency.....	6 Months

**DISCONNECT MACHINE FROM POWER SUPPLY!**

Lubricate the table lift screws, chain, and helical gear with lithium grease every 6 months. Clean the chain and table lift screws (see **Figure 26**), then apply grease onto the chain links and screw threads. Clean the helical gear (see **Figure 27**) and place a dab of grease on the teeth. Move the table up and down to spread the grease thoroughly throughout the mechanism.

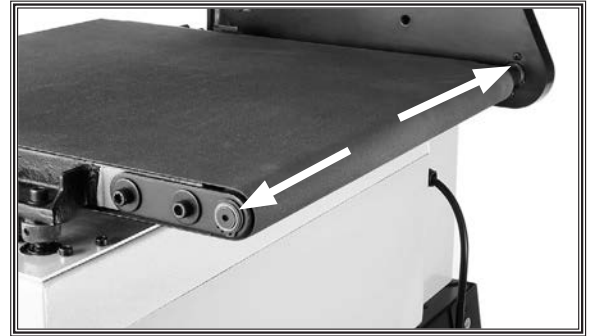

**Figure 25.** Conveyor belt bushing locations (drive-motor end).

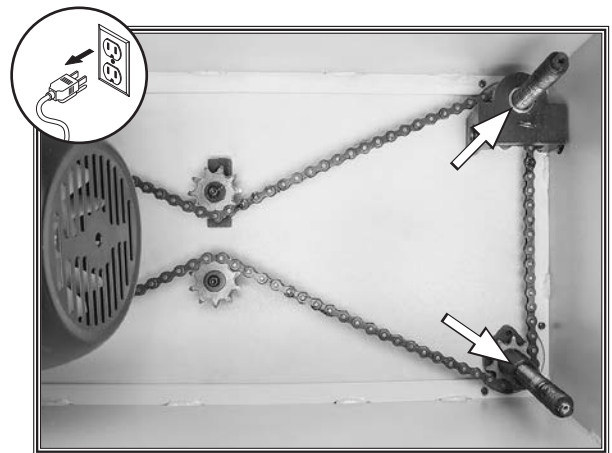

**Figure 26.** Table lift screws (2 of 4).

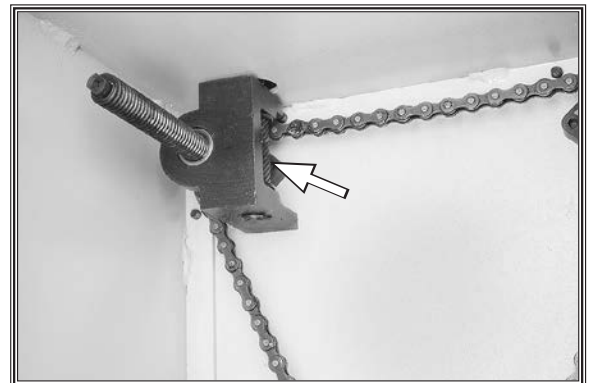

**Figure 27.** Helical gear location.



## Cleaning Sandpaper Belts

To increase the working life of your sandpaper belts, clean them whenever they decrease in performance due to heavy loading of material. Use a Shop Fox Model D3003 PRO-STIK® Cleaning Pad, as shown in **Figure 28**.

To clean sandpaper belt, do these steps:

1. DISCONNECT MACHINE FROM POWER!
2. Set table to thickness of cleaning pad.
3. Connect machine to power, then run pad through sander two or three times. DO NOT take too deep of a cut—the belt should barely touch cleaning pad!



**Figure 28.** D3003 PRO-STIK® Cleaning Pad.

# SERVICE

## General

This section covers the most common service adjustments or procedures that may need to be made during the life of your machine.

If you require additional machine service not included in this section, please contact Woodstock International Technical Support at (360) 734-3482 or send e-mail to: [techsupport@woodstockint.com](mailto:techsupport@woodstockint.com).

## Replacing V-Belt

A worn/damaged V-belt will not provide optimum power transmission from the motor to the drum belt. Inspect the V-belt closely; if you notice fraying, cracking, glazing, or any other damage, replace the belts.

V-belt removal and replacement is simply a matter of loosening the V-belt, rolling it off of the pulleys, replacing it with a new belt, then re-tensioning pulleys.

Items Needed	Qty
Hex Wrenches 4, 8mm .....	1 Ea.
Phillips Head Screwdriver #2.....	1
V-Belt (Part X1854069) .....	1
Straightedge .....	1

To replace V-belt, do these steps:

1. DISCONNECT MACHINE FROM POWER!
2. Remove pulley belt access cover.
3. Loosen motor mount cap screws shown in **Figure 29**.
4. Lift motor pulley to de-tension belt, and tighten motor mount cap screws (see **Figure 29**) to keep motor de-tensioned during belt change.
5. Roll V-belt off both pulleys and install new V-belt on pulley grooves for desired speed setting (see **Changing Sanding Drum Speeds on Page 27**).
6. Properly tension V-belt (refer to **Tensioning V-Belt on Page 33** for more information).
7. Re-install pulley belt access cover from **Step 2**.

**⚠ WARNING**

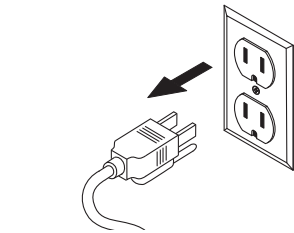

**MAKE SURE** that your machine is unplugged during all service procedures! If this warning is ignored, serious personal injury may occur.

**NOTICE**

New V-belts will often stretch and loosen after approximately 16 hours of use. Check frequently after installation and re-tension if necessary.

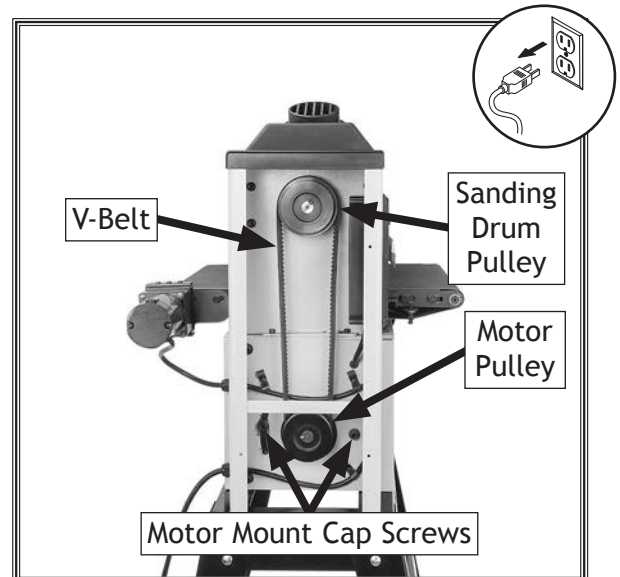

**Figure 29.** V-belt replacement adjustments.

# Tensioning V-Belt

Proper V-belt tension is important for optimum power transmission. However, too much tension may cause premature bearing failure.

Correct V-belt tension is achieved when the V-belt deflects  $\frac{1}{2}$ "– $\frac{3}{4}$ " when pushed in the middle with moderate pressure. See **Figure 30** for an example of how to perform a V-belt deflection test with a straightedge and ruler.

Items Needed	Qty
Hex Wrenches 4 & 8mm .....	1 Ea.
Phillips Screwdriver #2 .....	1
Straightedge .....	1
Fine Ruler 12" .....	1

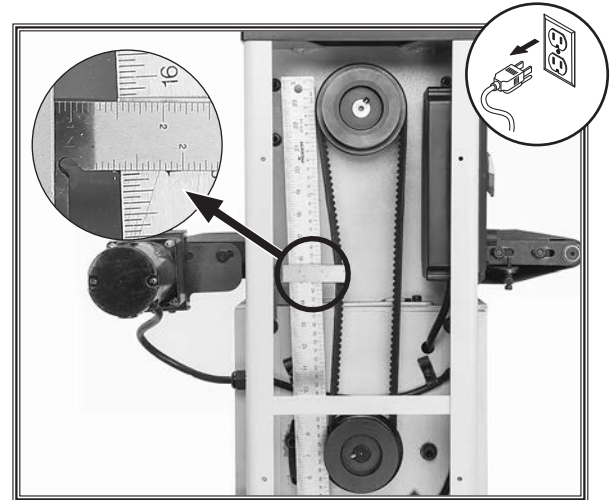

**Figure 30.** Checking V-belt tension with a straightedge and fine ruler.

**⚠ CAUTION**

Always inspect V-belts for damage or deterioration when adjusting for tension. Should you find evidence of cracking, abrasion or damage from wood chips or other foreign materials, replace the belt immediately. Belt breakage may lead to mechanical damage or operator injury.

To adjust V-belt tension, do these steps:

1. DISCONNECT MACHINE FROM POWER!
2. Open belt access panel.
3. Check tension of V-belt, then adjust tension by loosening motor mount cap screws (see **Figure 31**).
4. Tension V-belt by pushing down on bottom motor pulley with one hand, then tighten motor mount cap screws and check belt tension.
5. Repeat **Steps 3-4** as needed until V-belt is correctly tensioned, then replace belt access panel.

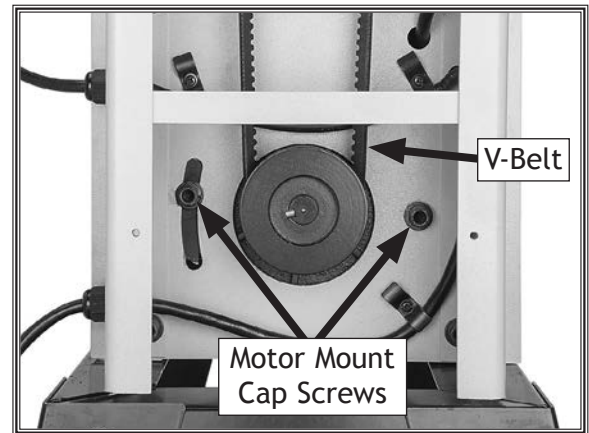

**Figure 31.** V-belt tension adjustments.

**NOTICE**

New V-belts will often stretch and loosen after moderate use. Check frequently after installation and re-tension if necessary.

# Aligning Pulleys

Pulley alignment is an important factor in power transmission and belt life. The pulleys should be parallel to each other and in the same plane (coplanar) for optimum performance.

Each pulley can be adjusted by loosening the set screw that secures the pulley to the shaft, sliding the pulley in/out, and retightening the set screw to lock the pulley in place.

Items Needed	Qty
Hex Wrenches 4, 8mm .....	1 Ea.
Phillips Screwdriver #2 .....	1
Pry Bar .....	1

To align pulleys, do these steps:

1. DISCONNECT MACHINE FROM POWER!
2. Open pulley cover.
3. Looking from top, sight down outside face of pulleys to see if sanding drum and motor pulleys are parallel and aligned with each other (see **Figure 32**).
  - If pulleys *are* aligned, go to **Step 7**.
  - If pulleys are *not* aligned, perform **Steps 4-6**.
4. Remove V-belt (see **Replacing V-Belt** on Page 32).
5. Loosen set screws on motor pulley and sanding drum pulley, then align both pulleys (see **Figure 33**).
6. Tighten set screws, replace V-belt, and repeat **Step 3** to verify proper pulley alignment. Pulleys should be parallel and aligned, as shown in **Figure 32**, when belt is properly tensioned.
7. Replace pulley cover.

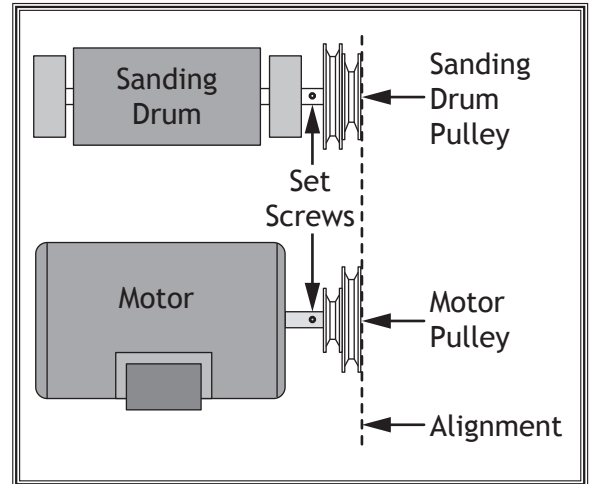

**Figure 32.** Pulleys must be parallel and aligned.

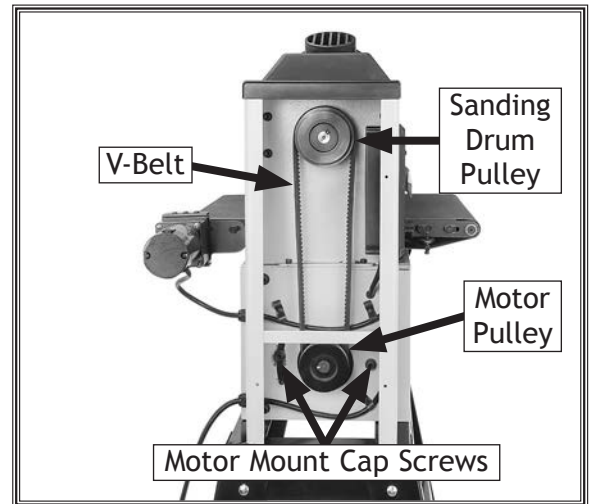

**Figure 33.** Belt-drive system.

# Tracking Conveyor Belt

The conveyor belt must track straight. If the feed belt tracks to either side, then the tracking must be corrected or the conveyor belt will become damaged and have to be replaced. The tracking was properly set at the factory, but it is the responsibility of the end user to keep it tracking properly during the life of the machine.

Tracking the conveyor belt is a balancing process that takes patience and a small degree of trial-and-error. You begin coarse tracking adjustment by rotating the right conveyor belt tensioning bolt clockwise or counterclockwise. If the belt continues to track to one side then you must over-tighten the loose side (the side the belt is tracking towards) to make the conveyor belt move to the middle of the rollers, then loosen that same side to make the feed belt stay in position. If you adjust the tracking screw too much either way, then you have to repeat the process until the conveyor belt rides in the middle and stays there during continuous operation.

**Note:** Tracking affects tension, so tension must always be adjusted after tracking (see **Page 37**).

Items Needed	Qty
Open-End Wrench 8mm .....	1
Hex Wrench 4mm .....	1

To adjust conveyor belt tracking, do these steps:

1. Turn conveyor belt *ON* and watch it track.
  - If the belt tracks evenly, leave it alone.
  - If the belt tracks toward the *right*, loosen lock nut shown in **Figure 34** and rotate the right-side conveyor belt tensioning bolt *counterclockwise* to move belt left.
  - If the belt tracks toward the *left*, loosen lock nut shown in **Figure 34** and rotate the right-side conveyor belt tensioning bolt *clockwise* to move belt right.

**⚠ CAUTION**

Working around moving conveyor and parts presents pinch/entanglement hazards that can cause personal injury. Use extreme care to keep hands clear of in-running pinch points while adjusting tracking nut/screw when machine is running. Roll up sleeves and do not wear gloves or other apparel that could become entangled in moving parts.

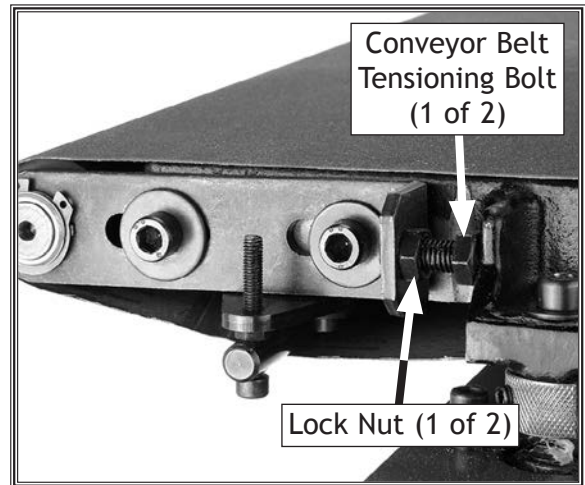

**Figure 34.** Conveyor coarse tracking controls.

2. After adjustments are made, run machine for approximately 15 minutes to watch the tracking adjustments you made. Be patient, belt tracks slowly.

–If the belt tracks evenly, leave it alone.

–If the belt moves to one side, immediately stop the machine and adjust the belt tracking before running the conveyor again. Proceed to **Step 3**.

3. Loosen lock nut (see **Figure 35**) on side that conveyor belt tracks towards and tension tracking adjustment screw until conveyor belt tracks in opposite direction.

**Note:** *Small tracking changes may take up to three minutes before they are noticeable.*

4. When conveyor belt is near middle of rollers or table, loosen tracking adjustment screw until feed belt stops moving and tracks straight.

– If conveyor belt tracks too far to the other side, loosen tracking adjustment screw as necessary to bring it back.

5. Repeat **Steps 3-4** until tracking is correct.

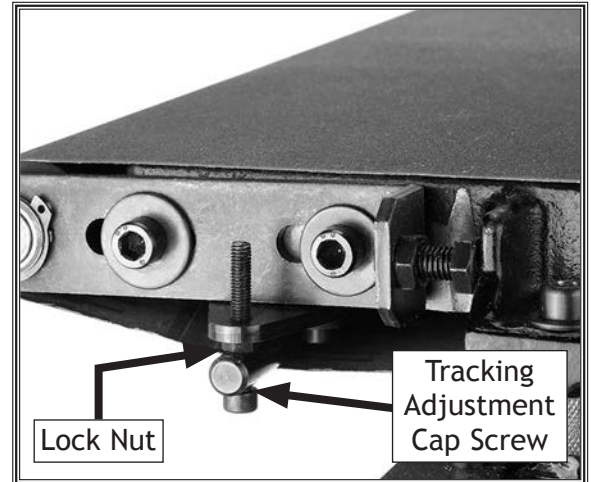

**Figure 35.** Conveyor fine tracking controls.

# Tensioning Conveyor Belt

The conveyor belt will stretch when new and will eventually need to be tensioned. This is most obvious if the conveyor belt starts slipping on the rollers.

When you tension the conveyor belt, focus on adjusting the tensioning bolts in even increments. Adjusting one side more than the other will cause tracking problems, which will require you to make additional adjustments to get the sander tracking correctly again.

Items Needed	Qty
Open-End Wrench 12mm.....	2
Hex Wrench 6mm .....	1
Permanent Marker (or other, see <b>Step 2</b> ).....	1

To adjust conveyor belt tension, do these steps:

1. Loosen feed roller cap screws, shown in **Figure 36**, on both sides of conveyor belt.
2. Use permanent marker, paper correction fluid, or fingernail polish to mark conveyor belt tensioning bolt on both sides. This step will aid you in keeping track of rotations as you turn bolts, so they remain as even as possible.
3. Turn machine **ON**.
4. Loosen lock nuts and turn both conveyor belt tensioning bolts clockwise one full turn at a time until conveyor belt no longer slips during operation.
  - If conveyor belt starts tracking to one side, back off the conveyor belt tensioning bolt that is being adjusted.
  - If conveyor belt continues tracking to one side, immediately turn machine **OFF** and follow **Tracking Conveyor Belt** instructions on **Page 35**.
5. Tighten lock nuts to lock conveyor belt tensioning bolts in place.

**Note:** When tensioned properly the belt should not lift off the table, slide back and forth, or slip.

6. Tighten feed roller cap screws when complete.

**⚠ CAUTION**

Working around moving conveyor and parts presents pinch/entanglement hazards that can cause personal injury. Use extreme care to keep hands clear of in-running pinch points while adjusting tracking nut/screw when machine is running. Roll up sleeves and do not wear gloves or other apparel that could become entangled in moving parts.

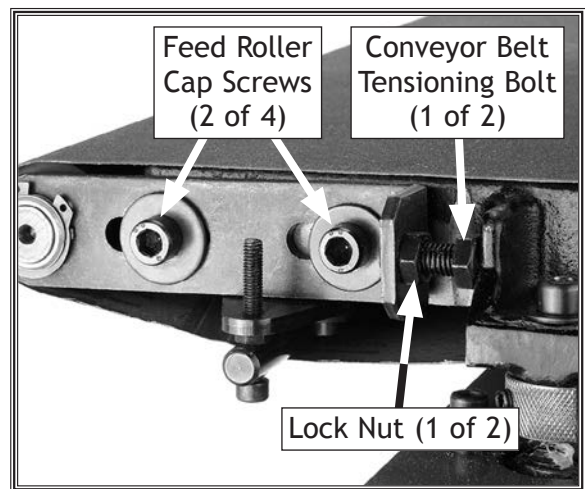

**Figure 36.** Conveyor belt tensioning controls.

**NOTICE**

**DO NOT** over-tension the feed belt. This may cause premature wearing of the belt and bushings, and cause strain on the motor.

# Replacing Conveyor Belt

Replacing the conveyor belt is a relatively simple process, but it will require re-tensioning and tracking once the new conveyor belt is installed.

Items Needed	Qty
Open-End Wrench 12mm.....	2
Hex Wrench 6mm .....	1
Permanent Marker (or other, see Step 2).....	1
An Assistant .....	1

To replace conveyor belt, do these steps:

1. DISCONNECT MACHINE FROM POWER!
2. Use a permanent marker, paper correction fluid, or fingernail polish to mark front of each conveyor belt tensioning bolt (see **Figure 37**) on both sides. This step will aid you in returning bolts to their original position, reducing amount of tracking necessary.
3. Loosen lock nuts shown in **Figure 37**. Turn both conveyor belt tensioning bolts counterclockwise one full turn at a time to release tension from conveyor belt.
4. Remove outside table cap screws shown in **Figure 38** and loosen corresponding cap screws on inside edge.
5. Have assistant lift outside edge of table, then slide conveyor belt off.
6. Clean any dirt or dust off table and rollers, have assistant lift table, then slide new conveyor belt on.
7. Re-install and tighten all table cap screws.
8. Tighten conveyor belt adjustment bolts equally, then follow tensioning instructions on **Page 37**.

**Note:** *The conveyor belt will stretch slightly when new and will need to be re-tensioned after a short amount of use.*

9. Track new conveyor belt according to instructions on **Page 35**.

**Note:** *One side of the conveyor belt may need to be tighter than the other for the belt to track straight.*

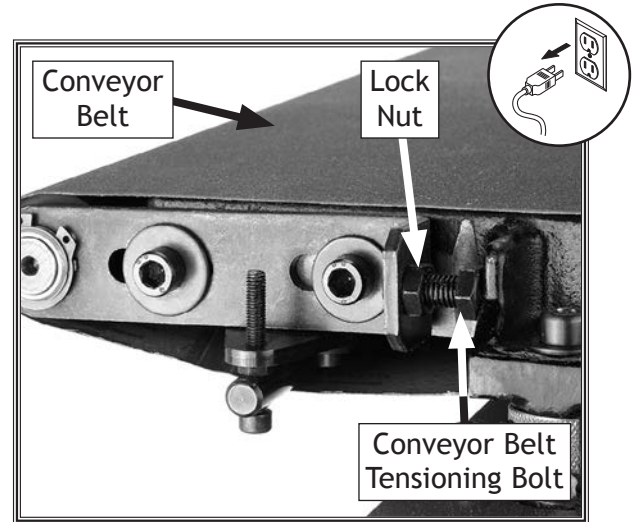

**Figure 37.** Conveyor belt tensioning controls (outside of table shown).



**Figure 38.** Conveyor belt table outside cap screws.



# Making Gauge Blocks

The gauge blocks described here will be required to complete the remaining service procedures in this section.

Items Needed	Qty
6' Long 2x4 .....	1
Miter Saw (or Circular Saw) .....	1
Jointer .....	1
Table Saw .....	1

To make gauge blocks, do these steps:

1. Edge joint concave edge of 2x4 flat on a jointer, as shown in **Figure 39**.
2. Place jointed edge of 2x4 against table saw fence and rip cut just enough off opposite side to square up two edges of the 2x4, as shown in **Figure 40**.
3. Cut 2x4 into two even pieces to make two 36" long wood gauge blocks.

**Note:** *Steps 1-2 can be skipped, but having the gauge blocks at an equal height is critical to the accuracy of your adjustments.*

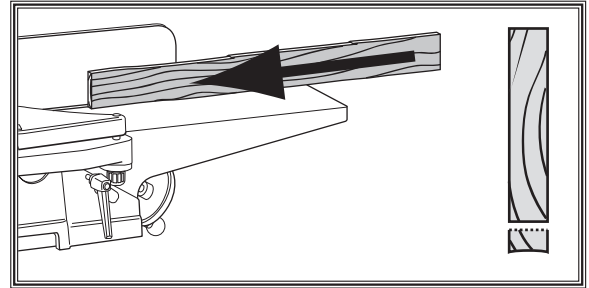

**Figure 39.** Edge jointing on a jointer.

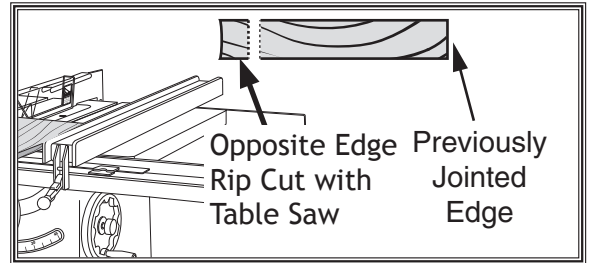

**Figure 40.** Rip cutting on a table saw.

# Aligning Drum

Aligning the drum parallel to the conveyor belt (see **Figure 41**) is critical for sanding accuracy. Care should be taken to make the tolerances as close as possible (within 0.002" from one side to the other) when adjusting the drum height.

Items Needed	Qty
Hex Wrenches 3, 6mm .....	1 Ea
Gauge Blocks (see <b>Page 39</b> ).....	2
Feeler Gauge Set .....	1

To align drum, do these steps:

1. DISCONNECT MACHINE FROM POWER!
2. Remove sandpaper from drum and place gauge blocks as shown in **Figure 42**.
3. Raise table until gauge blocks just touch drum.

*Note: A good way to know when they are touching is to rock the drum back and forth while raising the table until you hear or feel contact with the gauge blocks.*

4. Lower table one full crank of the handwheel (taking handwheel free-play into consideration; or in other words, wait until the chain starts moving before starting to count handwheel rotation).
5. Starting at one end, find thickest feeler gauge that can pass between drum and your gauge block. (The feeler gauge should slide with moderate resistance, without forcing drum to roll.)
6. Repeat **Step 5** at other end of the drum.
  - If the difference between the two sizes is 0.002" or less, then no adjustment is necessary.
  - If the difference between the two sizes is more than 0.002", then one end must be adjusted to within 0.002" of the other. Continue to **Step 7**.
7. Loosen table cap screws and adjust height of table by rotating adjustment knob shown in **Figure 43**.
8. Tighten table cap screws and repeat **Steps 5-6** until difference is 0.002" or less.

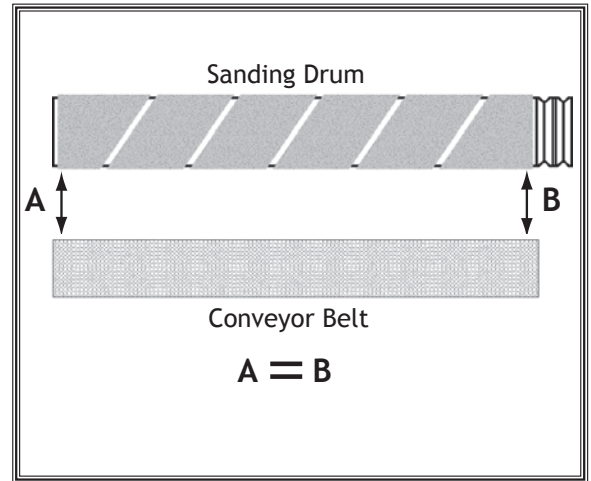

**Figure 41.** Drum parallel to conveyor belt.



**Figure 42.** Example of gauge blocks placed under drums.

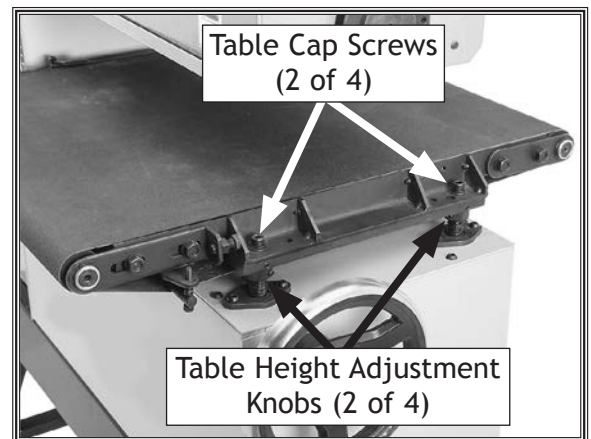

**Figure 43.** Table height adjustment knobs (outside knobs shown).

# Aligning Pressure Rollers

Two spring-loaded pressure rollers help maintain consistent pressure on the workpiece as it passes the sanding drum. The pressure rollers have been set correctly at the factory. **DO NOT** adjust the pressure rollers unless absolutely necessary.

When properly positioned, the pressure rollers should be approximately 0.004" lower than the drum.

Adjusting the pressure rollers is a fine balance between too much pressure and not enough. Too much pressure can cause problems like snipe or overloading the motor. Not enough pressure may allow the workpiece to kick out of the sander towards the operator.

Items Needed	Qty
Wrench 8mm.....	1
Hex Wrench 4mm .....	1
Gauge Blocks (see <b>Page 39</b> ) .....	2
Feeler Gauge Set .....	1

To check pressure rollers, do these steps:

1. **DISCONNECT MACHINE FROM POWER!**
2. Place gauge blocks on feed belt, as shown in **Figure 44**.
3. Raise table until blocks just touch the rear pressure roller.
4. Find the largest size feeler gauge that can pass between sanding drum and your gauge block. (The feeler gauge should slide with moderate resistance, without forcing drum to roll.)
  - If gap is 0.004" (0.1mm) or less, then no adjustment of rear pressure roller is necessary.
  - If gap is more than 0.004" (0.1mm), then rear pressure roller must be adjusted.
5. Raise table until gauge blocks just touch the drum.
6. Find the largest size feeler gauge that can pass between the front pressure roller and your gauge block. (The feeler gauge should slide with moderate resistance, without forcing the drum to roll.)



**Figure 44.** Example of gauge blocks placed under drum.

- If the gap is 0.004" (0.1mm) or less, then no adjustment of front pressure plate is necessary.
- If the gap is more than 0.004" (0.1mm), then front pressure plate must be adjusted.

**SERVICE**

To adjust rear pressure roller, do these steps:

1. DISCONNECT MACHINE FROM POWER!
2. Loosen hex nut securing tensioner cap screws on both ends of rear pressure roller shown in **Figure 45**.
3. Rotate cap screw clockwise to raise the pressure roller, or counterclockwise to lower pressure roller.
4. Adjust rear pressure roller until it is equal to or up to 0.004" (0.1mm) lower than height of the drum.

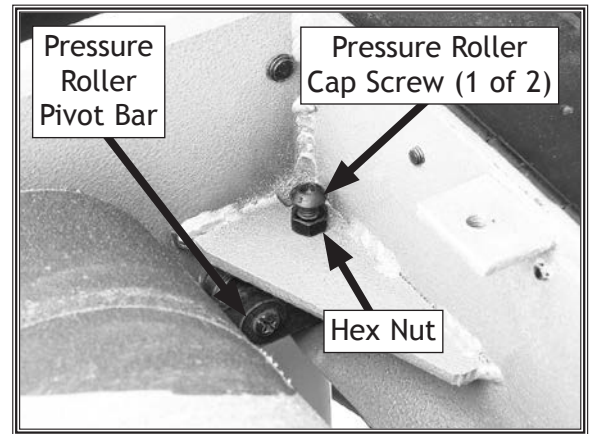

**Figure 45.** Rear pressure roller adjustments.

To adjust front pressure roller, do these steps:

1. DISCONNECT MACHINE FROM POWER!
2. Loosen hex nut securing adjustment cap screws on both ends of rear pressure roller shown in **Figure 46**.
3. Rotate cap screw clockwise to raise pressure roller, or counterclockwise loosen cap screw to lower pressure roller.
4. Adjust rear pressure roller until it is equal to, or up to 0.004" (0.1mm) lower than height of the drum.

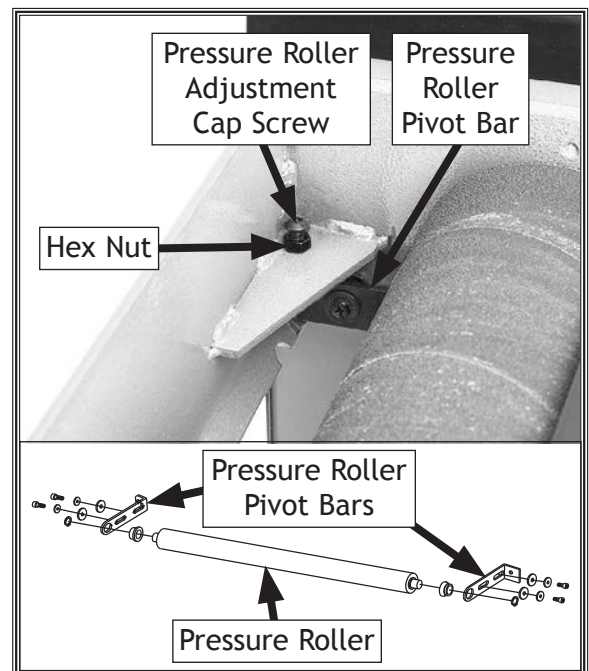
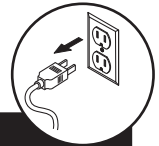

**Figure 46.** Front pressure roller adjustments and pressure roller overview.

# Troubleshooting

The following troubleshooting tables cover common problems that may occur with this machine. If you need replacement parts or additional troubleshooting help, contact our Technical Support.

**Note:** Before contacting Tech Support, find the machine serial number and manufacture date, and if available, your original purchase receipt. This information is required to properly assist you.



## Motor and Electrical

PROBLEM	POSSIBLE CAUSE	CORRECTIVE ACTION
Machine does not start or a breaker trips.	<ol style="list-style-type: none"> <li>1. Switch disabling key removed.</li> <li>2. Incorrect power supply voltage.</li> <li>3. Machine circuit breaker tripped.</li> <li>4. Power supply circuit breaker tripped or fuse blown.</li> <li>5. Start capacitor at fault.</li> <li>6. Centrifugal switch/contact points at fault.</li> <li>7. Wiring broken, disconnected, corroded, or improperly connected (if serviced prior to problem).</li> <li>8. Variable-speed dial at fault.</li> <li>9. Circuit board at fault.</li> <li>10. Motor at fault.</li> </ol>	<ol style="list-style-type: none"> <li>1. Install switch disabling key.</li> <li>2. Ensure correct power supply voltage.</li> <li>3. Reset circuit breaker on machine.</li> <li>4. Ensure circuit is sized correctly and free of shorts. Reset circuit breaker or replace fuse.</li> <li>5. Test/replace if at fault.</li> <li>6. Adjust/replace centrifugal switch/contact points if available.</li> <li>7. Check/fix broken, disconnected, misconnected, or corroded wires.</li> <li>8. Test/repair if at fault.</li> <li>9. Inspect/replace if at fault.</li> <li>10. Test/repair/replace.</li> </ol>
Machine stalls or is underpowered.	<ol style="list-style-type: none"> <li>1. Workpiece material is not suitable for machine.</li> <li>2. Excessive sanding depth.</li> <li>3. Feed rate/sanding speed too fast.</li> <li>4. Machine undersized for task.</li> <li>5. V-belt slipping.</li> <li>6. Motor overheated, tripping machine circuit breaker.</li> <li>7. Run capacitor at fault.</li> <li>8. Centrifugal switch/contact points at fault.</li> <li>9. Motor bearings at fault.</li> <li>10. Motor at fault.</li> </ol>	<ol style="list-style-type: none"> <li>1. Only sand wood or wood products/ensure moisture is below 20%.</li> <li>2. Reduce sanding depth.</li> <li>3. Decrease feed rate/sanding speed (<b>Page 27</b>).</li> <li>4. Clean/replace sandpaper (<b>Page 31</b>); reduce feed rate (<b>Page 23</b>) or sanding depth (<b>Page 22</b>).</li> <li>5. Inspect/tension/replace V-belt, align pulleys (<b>Pages 32, 33, 34</b>).</li> <li>6. Clean motor/let cool, and reduce workload. Reset breaker. Test/repair/replace.</li> <li>7. Test/repair/replace.</li> <li>8. Adjust/replace centrifugal switch/contact points if available.</li> <li>9. Test/repair/replace.</li> <li>10. Test/repair/replace.</li> </ol>
Machine has vibration or noisy operation.	<ol style="list-style-type: none"> <li>1. V-belt is loose, worn, damaged, or misaligned.</li> <li>2. Pulley loose.</li> <li>3. Motor or component loose.</li> <li>4. Motor fan rubbing on fan cover.</li> <li>5. Motor bearings at fault.</li> </ol>	<ol style="list-style-type: none"> <li>1. Inspect/replace V-belt (<b>Page 332</b>); re-align pulleys (<b>Page 34</b>).</li> <li>2. Re-align/replace shaft, pulley, set screw, and key (<b>Page 34</b>).</li> <li>3. Inspect/replace damaged bolts/nuts. Re-tighten with thread-locking fluid if necessary.</li> <li>4. Fix/replace fan cover; replace loose/damaged fan.</li> <li>5. Test by rotating shaft; rotational grinding/loose shaft requires bearing replacement.</li> </ol>

## Sanding Operations

PROBLEM	POSSIBLE CAUSE	CORRECTIVE ACTION
Grinding, screeching, or rubbing noise when sanding drum starts.	<ol style="list-style-type: none"> <li>1. Drum bearings insufficiently lubricated.</li> <li>2. Drum bearings are worn and need replacement.</li> </ol>	<ol style="list-style-type: none"> <li>1. Lubricate drum bearings (Page 30).</li> <li>2. Replace drum bearings.</li> </ol>
Short V-belt lifespan.	<ol style="list-style-type: none"> <li>1. Pulleys not aligned correctly.</li> <li>2. V-belt loose.</li> </ol>	<ol style="list-style-type: none"> <li>1. Align pulleys (Page 34).</li> <li>2. Properly tension V-belt (Page 332).</li> </ol>
Machine lacks power; drums stop turning under load.	<ol style="list-style-type: none"> <li>1. V-belt loose.</li> <li>2. Too much pressure on pressure plates.</li> </ol>	<ol style="list-style-type: none"> <li>1. Properly tension V-belt (Page 33).</li> <li>2. Raise pressure plates (Page 41).</li> </ol>
Conveyor belt slips or does not track correctly.	<ol style="list-style-type: none"> <li>1. Conveyor belt loose.</li> <li>2. Too much load on machine.</li> <li>3. Conveyor belt tracking is incorrect.</li> </ol>	<ol style="list-style-type: none"> <li>1. Adjust conveyor belt/tighten (Page 37).</li> <li>2. Decrease load.</li> <li>3. Track conveyor belt so it runs straight (Page 35).</li> </ol>
Sandpaper comes off drum or is loose.	<ol style="list-style-type: none"> <li>1. Sandpaper not properly wrapped onto drum.</li> <li>2. Sandpaper not cut to correct dimensions.</li> <li>3. Torn or damaged sandpaper.</li> <li>4. Sandpaper not tightened or fastened correctly.</li> <li>5. Sanding drum not parallel with table.</li> </ol>	<ol style="list-style-type: none"> <li>1. Re-install sandpaper (Page 25).</li> <li>2. Use sandpaper cut to correct dimensions (Page 25).</li> <li>3. Replace sandpaper (Page 25).</li> <li>4. Re-install sandpaper (Page 25).</li> <li>5. Adjust sanding drum parallel to table (Page 40).</li> </ol>
Sandpaper tears off drum.	<ol style="list-style-type: none"> <li>1. Sandpaper overlapping.</li> <li>2. Depth of cut too much.</li> </ol>	<ol style="list-style-type: none"> <li>1. Re-install sandpaper (Page 25).</li> <li>2. Depth of cut too much.</li> </ol>
Table elevation controls are stiff and hard to adjust.	<ol style="list-style-type: none"> <li>1. Table lock engaged.</li> <li>2. Table lift screws are dirty or loaded with sawdust.</li> <li>3. Chain idler sprocket cap screws overtightened.</li> <li>4. Elevation handwheel helical gear is dirty or loaded with sawdust.</li> </ol>	<ol style="list-style-type: none"> <li>1. Loosen elevation lock knob.</li> <li>2. Clean and re-grease table lift screws (Page 30).</li> <li>3. Adjust cap screws on idler sprocket so it can spin freely.</li> <li>4. Clean and re-grease the helical gear (Page 30).</li> </ol>
Burn marks on workpiece.	<ol style="list-style-type: none"> <li>1. Using too fine of sanding grit for depth of cut.</li> <li>2. Sandpaper loaded with sawdust and gum.</li> <li>3. Feed rate too slow.</li> <li>4. Sandpaper not properly wrapped onto drum.</li> <li>5. Worn sandpaper.</li> </ol>	<ol style="list-style-type: none"> <li>1. Use coarser grit sandpaper or decrease depth of cut (Page 24).</li> <li>2. Clean/replace sandpaper (Page 31).</li> <li>3. Increase feed rate.</li> <li>4. Re-install sandpaper (Page 25).</li> <li>5. Replace sandpaper (Page 25).</li> </ol>
Ripples or lines in workpiece.	<ol style="list-style-type: none"> <li>1. Uneven feed rate.</li> <li>2. Conveyor belt flexing or vibrating.</li> <li>3. Sanding drum deflecting from workpiece.</li> </ol>	<ol style="list-style-type: none"> <li>1. Maintain even feed rate through entire sanding operation.</li> <li>2. Reduce depth of cut or reduce feed rate. Tighten loose fasteners.</li> <li>3. Make sure elevation lock knob is tight.</li> </ol>
Excessive dust on workpiece/conveyor while sanding, poor dust collection.	<ol style="list-style-type: none"> <li>1. Dust collector undersized or too far away from machine.</li> <li>2. Dust collection ducting problem.</li> </ol>	<ol style="list-style-type: none"> <li>1. Install larger dust collector/relocate dust collector.</li> <li>2. Clear blockages, seal leaks, use smooth wall duct, eliminate bends, close other branches.</li> </ol>
Snipe marks in workpiece.	<ol style="list-style-type: none"> <li>1. Improper pressure roller tension.</li> <li>2. Workpiece too long to be supported without additional help.</li> </ol>	<ol style="list-style-type: none"> <li>1. Adjust pressure roller pressure (Page 41).</li> <li>2. Use an assistant or roller stands/tables on infeed and outfeed ends of conveyor to keep workpiece from bending.</li> </ol>
Workpiece kicks out of sander.	<ol style="list-style-type: none"> <li>1. Not enough pressure from the pressure plates.</li> </ol>	<ol style="list-style-type: none"> <li>1. Lower pressure plates (Page 41).</li> </ol>

# Electrical Safety Instructions

These pages are current at the time of printing. However, in the spirit of improvement, we may make changes to the electrical systems of future machines. Compare the manufacture date of your machine to the one stated in this manual, and study this section carefully.

If there are differences between your machine and what is shown in this section, call Technical Support at (360) 734-3482 for assistance BEFORE making any changes to the wiring on your machine. An updated wiring diagram may be available. **Note:** Please gather the serial number and manufacture date of your machine before calling. This information can be found on the main machine label.

## WARNING

**SHOCK HAZARD.** Working on wiring that is connected to a power source is extremely dangerous. Touching electrified parts will result in personal injury including but not limited to severe burns, electrocution, or death. Disconnect the power from the machine before servicing electrical components!

**QUALIFIED ELECTRICIAN.** Due to the inherent hazards of electricity, only a qualified electrician should perform wiring tasks on this machine. If you are not a qualified electrician, get help from one before attempting any kind of wiring job.

**WIRE CONNECTIONS.** All connections must be tight to prevent wires from loosening during machine operation. Double-check all wires disconnected or connected during any wiring task to ensure tight connections.

**WIRE/COMPONENT DAMAGE.** Damaged wires or components increase the risk of serious personal injury, fire, or machine damage. If you notice that any wires or components are damaged while performing a wiring task, replace those wires or components before completing the task.

**MODIFICATIONS.** Using aftermarket parts or modifying the wiring beyond what is shown in the diagram may lead to unpredictable results, including serious injury or fire.

**MOTOR WIRING.** The motor wiring shown in these diagrams is current at the time of printing, but it may not match your machine. Always use the wiring diagram inside the motor junction box.

**CAPACITORS/INVERTERS.** Some capacitors and power inverters store an electrical charge for up to 10 minutes after being disconnected from the power source. To reduce the risk of being shocked, wait at least this long before working on capacitors.

**CIRCUIT REQUIREMENTS.** You MUST follow the requirements at the beginning of this manual when connecting your machine to a power source.

**EXPERIENCING DIFFICULTIES.** If you are experiencing difficulties understanding the information included in this section, contact our Technical Support at (360) 734-3482.

### NOTICE

The photos and diagrams included in this section are best viewed in color. You can view these pages in color at [www.shopfox.biz](http://www.shopfox.biz).

### WIRING DIAGRAM COLOR KEY

BLACK	BLUE	YELLOW	LIGHT BLUE
WHITE	BROWN	YELLOW GREEN	BLUE WHITE
GREEN	GRAY	PURPLE	TUR-QUOISE
RED	ORANGE	PINK	

# Wiring Diagram

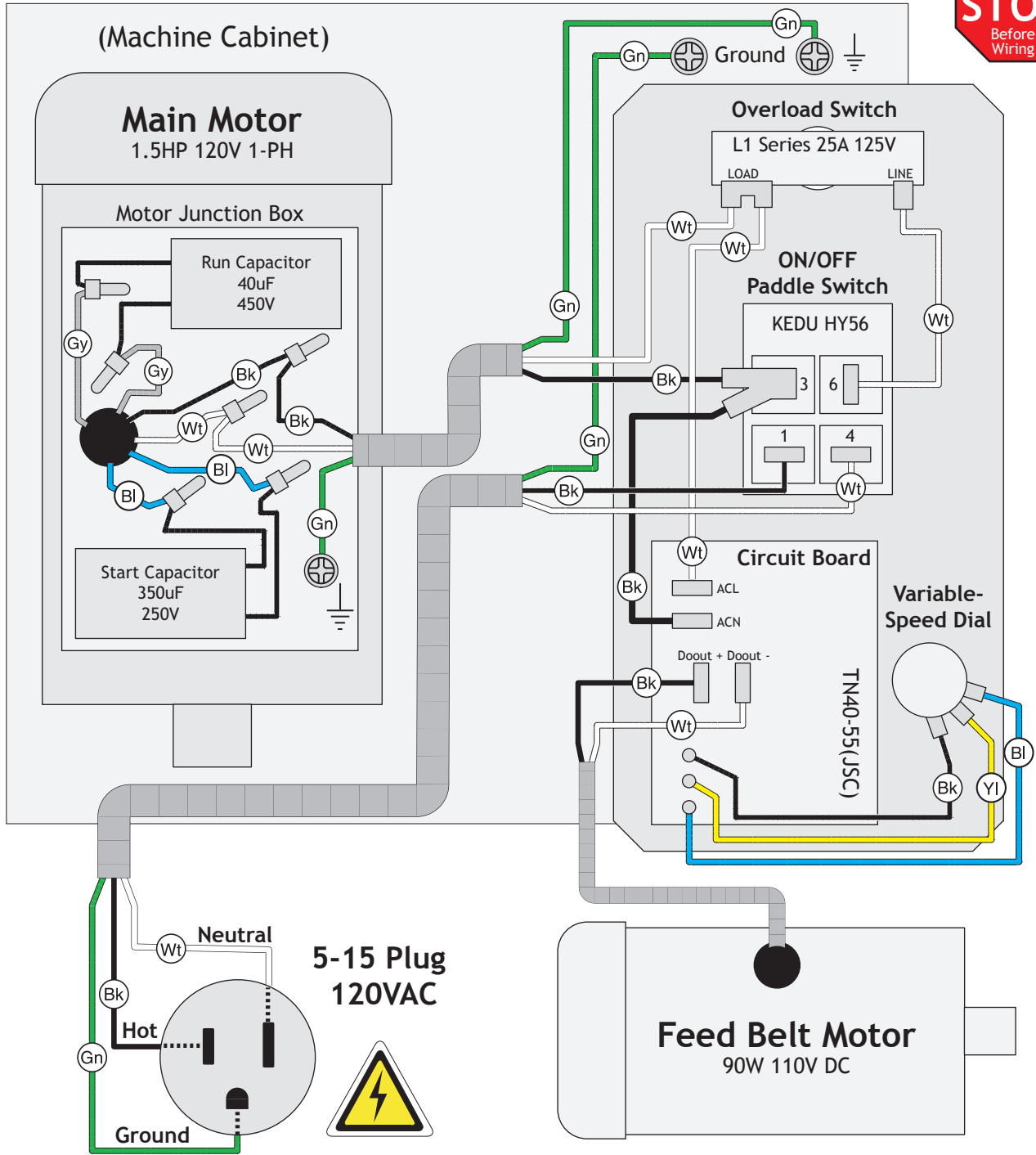

**NOTICE**

This motor wiring diagram is current at the time of printing; however, always use the diagram on the inside of the junction box cover when rewiring your motor!

SERVICE



# PARTS

## Main Breakdown

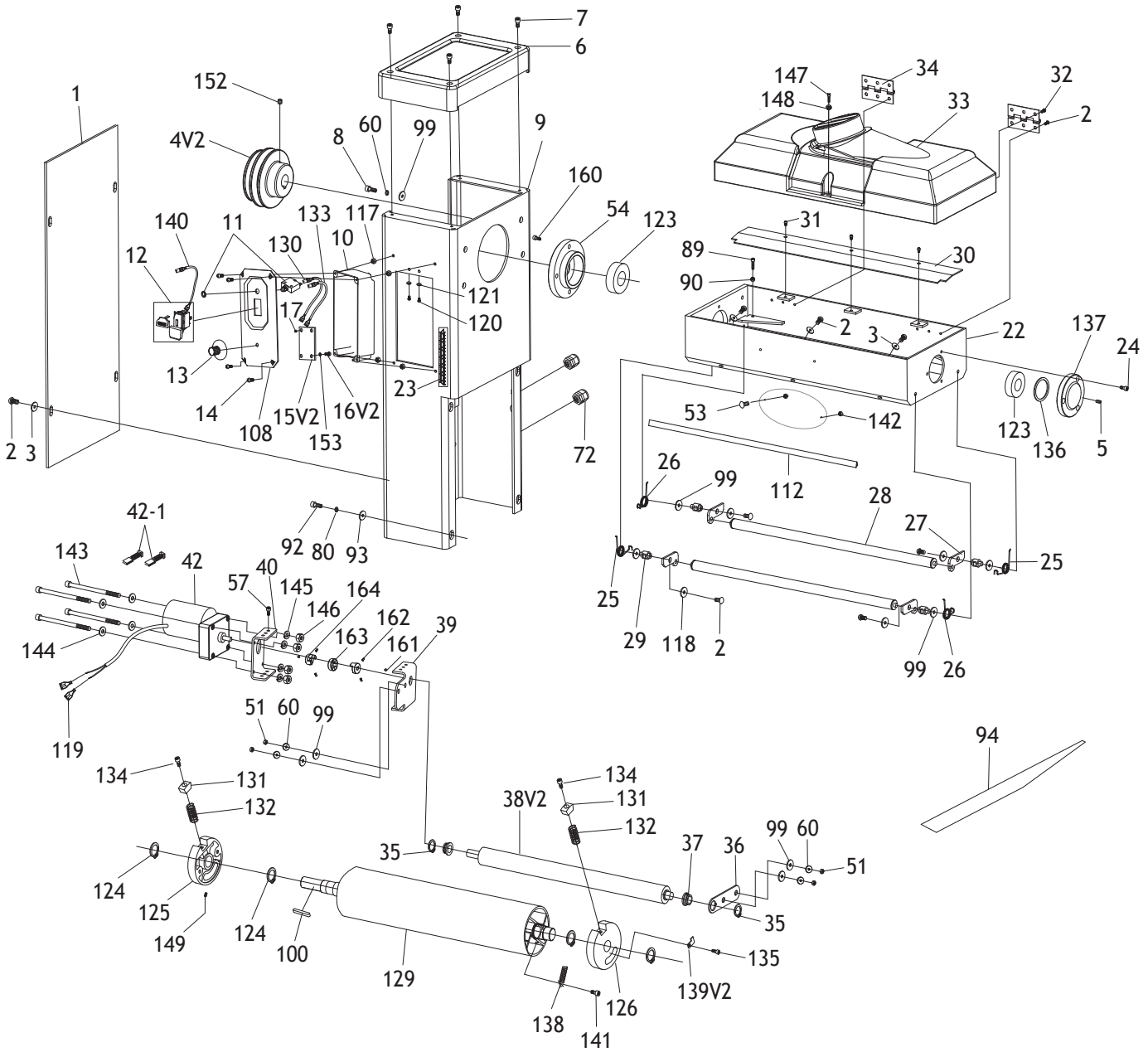

# Main Breakdown Cont.

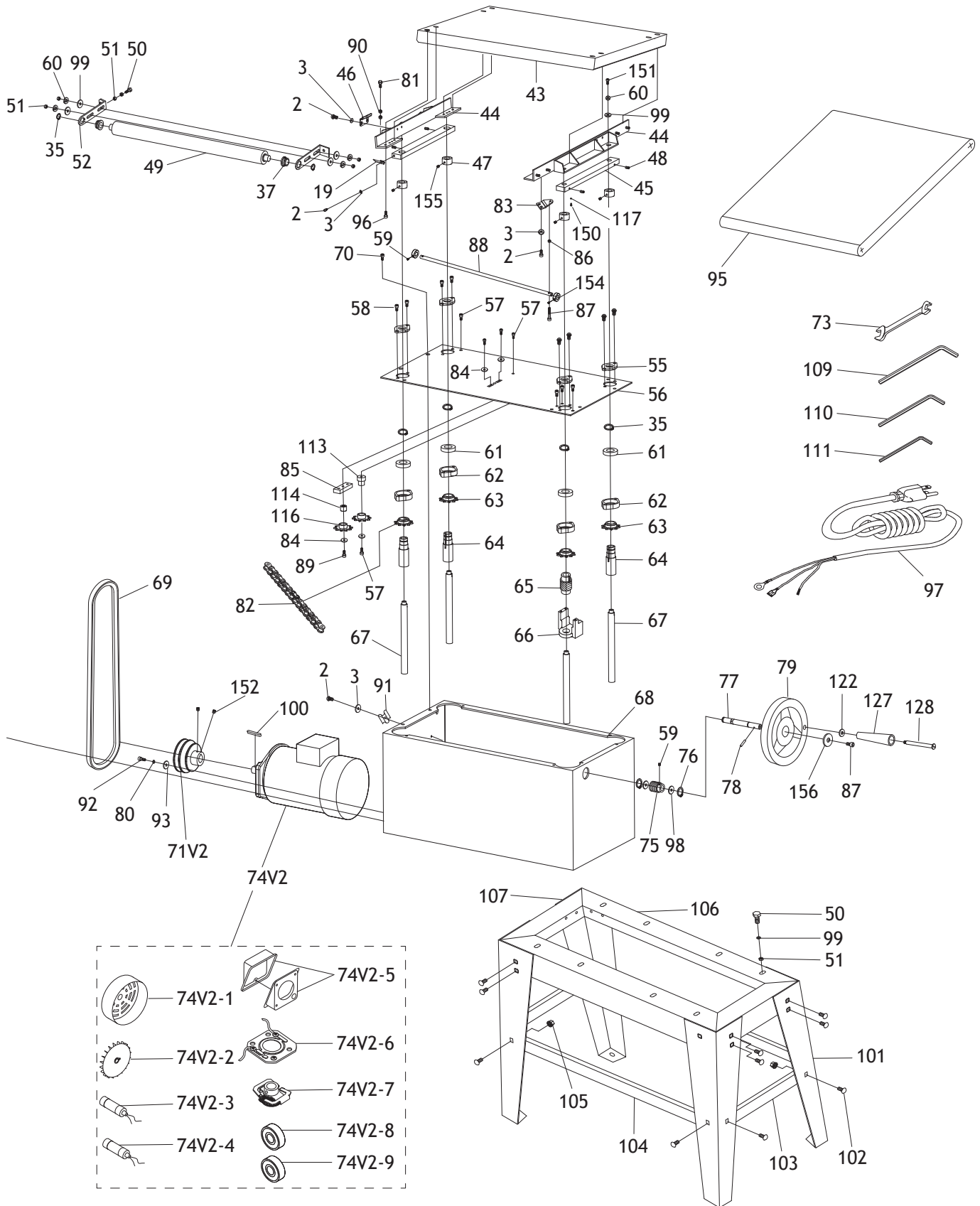

PARTS

# Main Parts List

REF	PART #	DESCRIPTION	REF	PART #	DESCRIPTION
1	X1854001	SIDE COVER	46	X1854046	PLATE
2	X1854002	PHLP HD SCR M5-.8 X 8	47	X1854047	LOCK COLLAR 16MM
3	X1854003	FLAT WASHER 5MM	48	X1854048	SET SCREW M5-.8 X 8
4	X1854004	DRIVE PULLEY V1	49	X1854049	FEED BELT ROLLER
5	X1854005	SET SCREW M6-1 X 10	50	X1854050	HEX BOLT M8-1.25 X 20
6	X1854006	FIXED COVER	51	X1854051	HEX NUT M8-1.25
7	X1854007	CAP SCREW M5-.8 X 16	52	X1854052	FEED ROLLER BRACKET (REAR)
8	X1854008	CAP SCREW M8-1.25 X 16	53	X1854053	CARRIAGE BOLT M3-.5 X 16
9	X1854009	SIDE CABINET	54	X1854054	BEARING COVER (LEFT)
10	X1854010	ELECTRICAL BOX COVER	55	X1854055	LEADSCREW FIXED PLATE
11	X1854011	CIRCUIT BREAKER L1 SERIES 25A	56	X1854056	BASE COVER PLATE
12	X1854012	PADDLE SAFETY SWITCH KEDU HY18-4P	57	X1854057	CAP SCREW M6-1 X 12
13	X1854013	POTENTIOMETER DIAL	58	X1854058	CAP SCREW M6-1 X 15
14	X1854014	PHLP HD SCR M5-.8 X 15	59	X1854059	SET SCREW M5-.8 X 5
15V2	X1854015V2	CIRCUIT BOARD W/POTENTIOMETER V2.08.22	60	X1854060	LOCK WASHER 8MM
16V2	X1854016V2	TAP SCREW M3 X 15	61	X1854061	BALL BEARING 6904ZZ
17	X1854017	SPACER (PLASTIC)	62	X1854062	BEARING SEAT
19	X1854019	POINTER	63	X1854063	SPROCKET
22	X1854022	HEAD CASTING	64	X1854064	ELEVATION SCREW CAP
23	X1854023	TABLE HEIGHT SCALE	65	X1854065	GEAR 65T
24	X1854024	CAP SCREW M6-1 X 12	66	X1854066	BRACKET
25	X1854025	TORSION SPRING (LT)	67	X1854067	ELEVATION SCREW ROD
26	X1854026	TORSION SPRING (RT)	68	X1854068	LOWER CASTING
27	X1854027	ROLLER MOUNTING PLATE	69	X1854069	V-BELT B40
28	X1854028	ROLLER	70	X1854070	CAP SCREW M8-1.25 X 12
29	X1854029	PIVOT SHOULDER PIN	71V2	X1854071V2	DRIVE PULLEY V2.07.19
30	X1854030	CHIP DEFLECTOR PLATE	72	X1854072	STRAIN RELIEF TYPE-3 M20-2.5
31	X1854031	CAP SCREW M6-1 X 10	73	X1854073	WRENCH 8 X 12 OPEN-ENDS
32	X1854032	TAP SCREW M5 X 10	74V2	X1854074V2	MOTOR 1.5HP 120V 1-PH V2.03.20
33	X1854033	TOP COVER	74V2-1	X1854074V2-1	MOTOR FAN COVER
34	X1854034	HINGE 3"	74V2-2	X1854074V2-2	MOTOR FAN
35	X1854035	EXT RETAINING RING 20MM	74V2-3	X1854074V2-3	S CAPACITOR 350M 250V
36	X1854036	FEED ROLLER BRACKET	74V2-4	X1854074V2-4	R CAPACITOR 40M 450M
37	X1854037	BUSHING	74V2-5	X1854074V2-5	JUNCTION BOX
38V2	X1854038V2	FEED BELT ROLLER V2.06.19	74V2-6	X1854074V2-6	CONTACT PLATE
39	X1854039	MOTOR SUPPORT BRACKET	74V2-7	X1854074V2-7	CENTRIFUGAL SWITCH
40	X1854040	MOTOR MOUNTING BRACKET	74V2-8	X1854074V2-8	BALL BEARING 6203-2RS (FRONT)
42	X1854042	FEED MOTOR 90W 110V DC	74V2-9	X1854074V2-9	BALL BEARING 6202-2RS (REAR)
42-1	X1854042-1	MOTOR BRUSHES (2-PC SET)	75	X1854075	WORM GEAR
43	X1854043	CONVEYOR TABLE	76	X1854076	EXT RETAINING RING 12MM
44	X1854044	TABLE GUIDE	77	X1854077	SHAFT
45	X1854045	STEEL BAR	78	X1854078	ROLL PIN 3 X 16

# Main Parts List Cont.

REF PART #	DESCRIPTION	REF PART #	DESCRIPTION		
79	X1854079	HANDWHEEL TYPE-3 181D X 12B-N X M8-1.25	121	X1854121	FLAT WASHER 5MM
80	X1854080	LOCK WASHER 10MM	122	X1854122	FLAT WASHER 8MM
81	X1854081	HEX BOLT M6-1 X 45	123	X1854123	BALL BEARING 6205ZZ
82	X1854082	CHAIN 410-132	124	X1854124	EXT RETAINING RING 25MM
83	X1854083	FIXED PLATE	125	X1854125	SANDING BELT CLAMP BRACKET (RT)
84	X1854084	FENDER WASHER 6MM	126	X1854126	SANDING BELT CLAMP BRACKET (LT)
85	X1854085	ADJUSTMENT BLOCK	127	X1854127	HOLLOW HANDLE 26 X 106, 10
86	X1854086	HEX NUT M5-.8	128	X1854128	SHOULDER SCR M8-1.25 X 13, 9 X 115
87	X1854087	CAP SCREW M5-.8 X 35	129	X1854129	BELT DRUM
88	X1854088	ADJUSTMENT ROD	130	X1854130	CONNECTION WIRE 2, 14AWG, 100L
89	X1854089	CAP SCREW M6-1 X 20	131	X1854131	BELT LOCKING BLOCK
90	X1854090	HEX NUT M6-1	132	X1854132	COMPRESSION SPRING
91	X1854091	CORD CLAMP	133	X1854133	CONNECTION WIRE 1, 14AWG, 100L
92	X1854092	CAP SCREW M10-1.5 X 25	134	X1854134	CAP SCREW M6-1 X 25
93	X1854093	FLAT WASHER 10MM	135	X1854135	CAP SCREW M5-.8 X 10
94	X1854094	SANDING BELT 100-GRIT 3" X 84"	136	X1854136	WAVY WASHER 40MM
95	X1854095	CONVEYOR BELT	137	X1854137	BEARING COVER (RIGHT)
96	X1854096	CAP SCREW M6-1 X 30	138	X1854138	EXTENSION SPRING
97	X1854097	POWER CORD 14G 3W 72" 5-15P	139V2	X1854139V2	SPRING RETAINER V2. 11.20
98	X1854098	FLAT WASHER 12MM	140	X1854140	CONNECTION WIRE 3, 14AWG, 50L
99	X1854099	FLAT WASHER 8MM	141	X1854141	CAP SCREW M5-.8 X 12
100	X1854100	KEY 6 X 6 X 40	142	X1854142	HEX NUT M3-.5
101	X1854101	STAND LEG	143	X1854143	CAP SCREW M5-.8 X 60
102	X1854102	HEX BOLT M8-1.25 X 16	144	X1854144	FLAT WASHER 5MM
103	X1854103	SHORT BRACKET (BOTTOM)	145	X1854145	LOCK WASHER 5MM
104	X1854104	LONG BRACKET (BOTTOM)	146	X1854146	HEX NUT M5-.8
105	X1854105	FLANGE NUT M8-1.25	147	X1854147	CAP SCREW M6-1 X 20
106	X1854106	LONG BRACKET (TOP)	148	X1854148	FLAT WASHER 6MM
107	X1854107	SHORT BRACKET (TOP)	149	X1854149	SET SCREW M8-1.25 X 20
108	X1854108	CONTROL PANEL PLATE	150	X1854150	HEX BOLT M5-.8 X 25
109	X1854109	HEX WRENCH 6MM	151	X1854151	CAP SCREW M8-1.25 X 16
110	X1854110	HEX WRENCH 5MM	152	X1854152	SET SCREW M8-1.25 X 10
111	X1854111	HEX WRENCH 4MM	153	X1854153	FLAT WASHER 3MM
112	X1854112	INFEED COVER	154	X1854154	COLLAR
113	X1854113	SPACER BLOCK	155	X1854155	SET SCREW M6-1 X 6
114	X1854114	BUSHING	156	X1854156	FLAT WASHER 5MM
116	X1854116	SPROCKET	160	X1854160	CAP SCREW M3-.5 X 6
117	X1854117	HEX NUT M5-.8	161	X1854161	KEY 4 X 4 X 8
118	X1854118	FENDER WASHER 6MM	162	X1854162	SET SCREW M4-.7 X 8
119	X1854119	SPADE TERMINAL (F)	163	X1854163	RUBBER CUSHION
120	X1854120	CAP SCREW M5-.8 X 8	164	X1854164	BUSHING

# Labels & Cosmetics



**MODEL W1854**  
**18" OPEN-END DRUM SANDER**

**WARNING!**

---

**Specifications**

Motor: 1.5 HP, 120V, 1-Phase, 60 Hz  
 Full-Load Current Rating: 13.92A  
 Max. Board Width: 36"  
 Min. Board Width: 1"  
 Max. Board Thickness: 4-1/2"  
 Min. Board Thickness: 1/8"  
 Min. Board Length: 6'  
 Conveyor Feed Rate: 0-12 FPM  
 Sandpaper Speed: 2800-3400 FPM  
 Sandpaper Length: 88-1/8"  
 Sandpaper Width: 3"  
 Sanding Belt Tension: Spring Loaded  
 Weight: 188 lbs.

To reduce the risk of serious injury while using this machine:

1. Read and understand owner's manual before operating.
2. Always wear approved eye protection and respirator.
3. Only plug power cord into a grounded outlet.
4. Never place hands near or in any opening during operation.
5. Never touch moving sandpaper or conveyor belt.
6. Never sand more than one board at a time.
7. Make sure sander is properly assembled, adjusted, and stable before operating. Only operate with top cover closed and secured.
8. Be aware of pinch points located at the edge of conveyor.
9. Only remove jammed pieces when machine is stopped and disconnected from power.
10. Turn motor OFF and disconnect power before changing sandpaper, opening machine, or servicing.
11. Do not wear loose clothing, gloves, jewelry, or other articles that can get entangled. Tie back long hair and roll up sleeves.
12. Do not expose to rain or use in wet locations.
13. Do not operate under influence of drugs or alcohol, or if tired.
14. Prevent unauthorized use by children or untrained users; restrict access or disable machine when unattended.

REF PART #	DESCRIPTION
201	X1854201 READ MANUAL LABEL
202	X1854202 DISCONNECT POWER LABEL
203	X1854203 SHOP FOX NAME PLATE (SMALL)
204	X1854204 EYE/LUNG HAZARD WARNING LABEL
205	X1854205 ENTANGLEMENT WARNING LABEL

REF PART #	DESCRIPTION
206	X1854206 MACHINE ID LABEL
207	X1854207 MODEL NUMBER LABEL
208	X1854208 ELECTRICITY LABEL
209	X1854209 TOUCH-UP PAINT, SHOP FOX WHITE
210	X1854210 TOUCH-UP PAINT, GLOSSY BLACK

**⚠ WARNING**

Safety labels warn about machine hazards and how to prevent serious personal injury. The owner of this machine **MUST** maintain the original location and readability of all labels on this machine. If any label is removed or becomes unreadable, **REPLACE** that label before allowing machine to be operated again. Contact us at (360) 734-3482 or [www.woodstockint.com](http://www.woodstockint.com) to order new labels.

-51-

PARTS



# WARRANTY

Woodstock International, Inc. warrants all Shop Fox machinery to be free of defects from workmanship and materials for a period of two years from the date of original purchase by the original owner. This warranty does not apply to defects due directly or indirectly to misuse, abuse, negligence or accidents, lack of maintenance, or reimbursement of third party expenses incurred.

Woodstock International, Inc. will repair, replace, or arrange for a dealer refund, at its expense and option, the Shop Fox machine or machine part proven to be defective for its designed and intended use, provided that the original owner returns the product prepaid to an authorized warranty or repair facility as designated by our Bellingham, Washington office with proof of their purchase of the product within two years, and provides Woodstock International, Inc. reasonable opportunity to verify the alleged defect through inspection. If it is determined there is no defect, or that the defect resulted from causes not within the scope of Woodstock International Inc.'s warranty, then the original owner must bear the cost of storing and returning the product.

This is Woodstock International, Inc.'s sole written warranty and any and all warranties that may be implied by law, including any merchantability or fitness, for any particular purpose, are hereby limited to the duration of this written warranty. We do not warrant that Shop Fox machinery complies with the provisions of any law, acts or electrical codes. We do not reimburse for third party repairs. In no event shall Woodstock International, Inc.'s liability under this limited warranty exceed the purchase price paid for the product, and any legal actions brought against Woodstock International, Inc. shall be tried in the State of Washington, County of Whatcom. We shall in no event be liable for death, injuries to persons or property or for incidental, contingent, special or consequential damages arising from the use of our products.

Every effort has been made to ensure that all Shop Fox machinery meets high quality and durability standards. We are committed to continuously improving the quality of our products, and reserve the right to change specifications at any time.

To register the warranty, go to <https://www.woodstockint.com/warranty>, or scan the QR code below. You will be directed to the Warranty Registration page on [www.woodstockint.com](http://www.woodstockint.com). Enter all applicable production information.





## High Quality Machines and Tools

Woodstock International, Inc. carries thousands of products designed to meet the needs of today's woodworkers and metalworkers.

Ask your dealer about these fine products:

**BROSMAN**  
PRECISION STOP BLOCK

**JOINTER PAL**<sup>®</sup>

**Rotacator**<sup>®</sup>

**STEELEX**<sup>®</sup>  
FINE TOOLS

**PLANER PAL**<sup>®</sup>

**THE REBEL**<sup>®</sup>

**PRO-STIK**<sup>®</sup>  
ABRASIVE BELT & DISC CLEANER

**BOARD BUDDIES**<sup>®</sup>

**WOODSTOCK**  
**SHOP FOX**<sup>®</sup>  
**INTERNATIONAL**

**STEELEX**<sup>®</sup>  
**PLUS**

**SLICKPLANE**<sup>®</sup>

*Aluma-Classic*<sup>®</sup>

**ACCU-SHARP**<sup>®</sup>

**ROMAN**  
**CARBIDE**<sup>®</sup>

**PARROT VISE**<sup>®</sup>

**WHOLESALE ONLY**

**WOODSTOCK INTERNATIONAL, INC.**

Phone: (360) 734-3482 • Fax: (360) 671-3053 • Toll Free Fax: (800) 647-8801

P.O.Box 2309 • Bellingham, WA 98227

**SHOPFOX.BIZ**