

# **POWERMATIC<sup>®</sup>**

## **Operating Instructions and Parts Manual CNC Routers**

**Models PM-2X2R and PM-2X4SP**

(router not included)



PM-2X2R



PM-2X4SP

**Powermatic**  
427 New Sanford Road  
LaVergne, Tennessee 37086  
Ph.: 1-855-336-4034  
[www.powermatic.com](http://www.powermatic.com)  
[cnc@powermatic.com](mailto:cnc@powermatic.com)

**Part No. M-1797022**  
Edition 7 10/2019  
ECR 191021085422  
Copyright © 2017 Powermatic



## 1.0 IMPORTANT SAFETY INSTRUCTIONS

When using an electrical appliance, basic precautions should always be followed, including the following.

### **WARNING – To reduce risk of injury:**

1. Read and understand the entire owner's manual before attempting assembly or operation.
2. Read and understand the warnings posted on the machine and in this manual. Failure to comply with all of these warnings may cause serious injury.
3. Replace the warning labels if they become obscured or removed.
4. This CNC routing machine is designed and intended for use by properly trained and experienced personnel only. If you are not familiar with the proper and safe operation of a CNC routing machine, do not use until proper training and knowledge have been obtained.
5. Do not use this machine for other than its intended use. If used for other purposes, Powermatic disclaims any real or implied warranty and holds itself harmless from any injury that may result from that use.
6. Always wear approved safety glasses/face shield while using this routing machine. Everyday eyeglasses only have impact resistant lenses; they are *not* safety glasses.
7. Before operating this machine, remove tie, rings, watches and other jewelry, and roll sleeves up past the elbows. Do not wear loose clothing. Confine long hair. Non-slip footwear or anti-skid floor strips are recommended. Do not wear gloves.
8. Wear ear protectors (plugs or muffs) during extended periods of operation.
9. Do not operate this machine while tired or under the influence of drugs, alcohol or any medication.
10. Make certain the switch is in the OFF position before connecting the machine to the power supply.
11. Make certain the machine is properly grounded.
12. Make all machine adjustments or maintenance with the machine unplugged from the power source.
13. Remove adjusting keys and wrenches. Form a habit of checking to see that keys and adjusting wrenches are removed from the machine before turning it on.
14. Keep safety guards in place at all times when the machine is in use. If removed for maintenance purposes, use extreme caution and replace the guards immediately after completion of maintenance.
15. Check damaged parts. Before further use of the machine, a guard or other part that is damaged should be carefully checked to determine that it will operate properly and perform its intended function. Check for alignment of moving parts, binding of moving parts, breakage of parts, mounting and any other conditions that may affect its operation. A guard or other part that is damaged should be properly repaired or replaced.
16. Provide for adequate space surrounding work area and non-glare, overhead lighting.
17. Keep the floor around the machine clean and free of scrap material, oil and grease.
18. Keep visitors a safe distance from the work area. Keep children away.
19. Make your workshop child proof with padlocks, master switches or by removing starter keys.
20. Give your work undivided attention. Looking around, carrying on a conversation and "horse-play" are careless acts that can result in serious injury.
21. Maintain a balanced stance at all times so that you do not fall into the cutter or other moving parts. Do not overreach or use excessive force to perform any machine operation. Keep hands away from rotating cutting tool.
22. Use the right tool at the correct speed and feed rate. Do not force a tool or attachment to do a job for which it was not designed. The right tool will do the job better and more safely.
23. Do not touch a bit immediately after use; it will be hot and may cause skin burns.
24. Use recommended accessories; improper accessories may be hazardous.
25. Maintain tools with care. Do not use dull or damaged cutters. Keep cutting tools clean and sharp for best and safest performance. Follow instructions for lubricating and changing accessories.

26. Turn off the machine before cleaning. Use a brush or compressed air to remove chips or debris — do not use your hands.
27. Do not stand on the machine. Serious injury could occur if the machine tips over.
28. Never leave the machine running unattended. Turn the power off and do not leave the machine until it comes to a complete stop.
29. Remove loose items and unnecessary work pieces from the area before starting the machine.
30. Don't use in dangerous environment. Don't use power tools in damp or wet location, or expose them to rain. Keep work area well lighted.
31. Keep electrical cord away from sharp edges, heat or moving parts. Position cord so it will not become a trip hazard.
32. Do not plug router directly into wall outlet. Connect it to the provided cable receptacle on the router table, so that all machine movement can be regulated by the single controller.
33. Before using the PM-2X2R routing machine, read and become thoroughly familiar with all manufacturer's operating and safety instructions that accompanied the router you will be using.
34. Always secure workpiece to spoil board using clamps or double-sided tape. Never hold workpiece down by hand while operating.
35. Make sure workpiece is free from nails or other foreign objects.
36. After installing a bit, make sure collet is securely tightened. An unsecured bit may fly loose from the collet and cause injury.
37. Use proper extension cord. Make sure your extension cord is in good condition. When using an extension cord, be sure to use one heavy enough to carry the current your product will draw. An undersized cord will cause a drop in line voltage resulting in loss of power and overheating. Table 1 (sect. 8.2) shows the correct size to use depending on cord length and nameplate ampere rating. If in doubt, use the next heavier gage. The smaller the gage number, the heavier the cord.
38. This machine is intended for cutting wood, acrylics and certain plastics only. Do not use it to cut metal.

**⚠ WARNING:** This product can expose you to chemicals including lead which is known to the State of California to cause cancer and birth defects or other reproductive harm. For more information go to <http://www.p65warnings.ca.gov>.

**⚠ WARNING:** Drilling, sawing, sanding or machining wood products generates wood dust and other substances known to the State of California to cause cancer. Avoid inhaling dust generated from wood products or use a dust mask or other safeguards for personal protection.

Wood products emit chemicals known to the State of California to cause birth defects or other reproductive harm. For more information go to <http://www.p65warnings.ca.gov/wood>.

Familiarize yourself with the following safety notices used in this manual:

**⚠ CAUTION**

This means that if precautions are not heeded, it may result in minor injury and/or possible machine damage.

**⚠ WARNING**

This means that if precautions are not heeded, it may result in serious injury or possibly even death.

## 1.1 Switch lock-out

To safeguard your machine from unauthorized operation and accidental starting by young children, the use of a padlock (not included) is highly recommended. See Figure 1-1.

To lock out the emergency switch:

1. Press E-stop button to engage emergency stop.
2. Insert padlock through hole in E-stop guard, and close padlock. (Padlock shaft must be thick enough to prevent E-stop button from disengaging.)
3. Place key in a location inaccessible to children and others not qualified to use the tool.

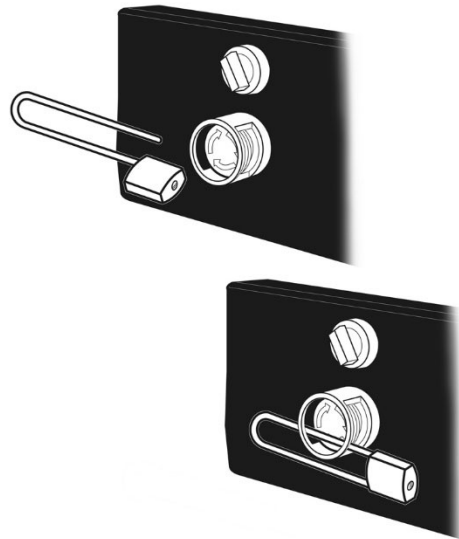

Figure 1-1

## 2.0 About this manual

This manual is provided by Powermatic covering the safe operation and maintenance procedures for a Powermatic Model PM-2X2R and PM-2X4SP CNC Router. This manual contains instructions on installation, safety precautions, general operating procedures, maintenance instructions and parts breakdown. Your machine has been designed and constructed to provide consistent, long-term operation if used in accordance with the instructions set forth in this document.

This manual is not intended to be an exhaustive guide to CNC operational methods, use of jigs or after-market accessories, choice of stock or cutting bits, etc. Additional knowledge can be obtained from experienced users or trade articles. Whatever accepted methods are used, always make personal safety a priority.

If there are questions or comments, please contact your local supplier or Powermatic. Powermatic can also be reached at our web site: [www.powermatic.com](http://www.powermatic.com), or via e-mail: [cnc@powermatic.com](mailto:cnc@powermatic.com).

Retain this manual for future reference. If the machine transfers ownership, the manual should accompany it.

**⚠WARNING** Read and understand the entire contents of this manual before attempting assembly or operation! Failure to comply may cause serious injury!

# 3.0 Table of contents

Section	Page
1.0 IMPORTANT SAFETY INSTRUCTIONS .....	2
1.1 Switch lock-out .....	4
2.0 About this manual .....	4
3.0 Table of contents .....	5
4.0 CNC router features .....	7
5.0 Specifications for Powermatic CNC Router Machines .....	8
6.0 Glossary .....	9
7.0 Setup and assembly .....	10
7.1 Shipping contents for PM-2X2R .....	10
7.2 Unpacking and cleanup .....	11
7.3 Tools required for assembly .....	11
7.4 Shipping contents for PM-2X4SP .....	12
7.5 Unpacking and cleanup .....	13
7.6 Tools required for assembly .....	13
7.7 Assembling stand (all models) .....	14
7.8 Installing router table on stand .....	15
7.9 Completing assembly .....	16
7.10 Installing router (PM-2X2R only) .....	16
7.11 Installing top guard .....	17
8.0 Electrical connections .....	17
8.1 GROUNDING INSTRUCTIONS .....	17
8.2 Extension cords .....	18
9.0 Setup for operation .....	18
9.1 Spoil board preparation .....	18
9.2 Spindle setup (PM-2X4SP only) .....	19
9.3 Router bit selection .....	19
9.4 Dust collection .....	19
10.0 Operations .....	19
10.1 Controller overview .....	19
10.2 Inverter (PM-2X4SP only) .....	20
10.3 Operating procedure .....	20
10.4 HOME position (machine origin) .....	20
10.5 Moving router head .....	20
10.6 Setting work origin .....	21
10.7 Processing a file .....	21
10.8 Advanced processing .....	22
10.9 Data restore .....	22
10.10 System updates .....	22
11.0 Controller functions .....	23
11.1 Keypad basic functions .....	23
11.2 Frequent keypad combinations .....	24
11.3 MENU key hierarchy and description .....	24
11.4 "Advanced Processing" hierarchy .....	27
12.0 User-maintenance .....	28
12.1 General maintenance .....	28
12.2 Coolant (PM-2X4SP only) .....	28
12.3 Lubrication .....	28
12.4 Additional servicing .....	28
13.0 Additional accessories .....	28
14.0 Troubleshooting PM-2X2R and PM-2X4SP CNC routers .....	29
14.1 Mechanical and electrical problems .....	29
14.2 Controller function problems .....	30
15.0 Replacement Parts .....	32
15.1.1 PM-2X2R Assembly I – Exploded View .....	33
15.1.2 PM-2X2R Assembly II – Exploded View .....	34
15.1.3 PM-2X2R Assemblies – Parts List .....	35
15.2.1 PM-2X2S Stand Assembly – Exploded View .....	37
15.2.2 PM-2X2S Stand Assembly – Parts List .....	37
15.3.1 PM-2X4SP Assembly I – Exploded View .....	38

15.3.2	PM-2X4SP Assembly II – Exploded View .....	39
15.3.3	PM-2X4SP Assemblies – Parts List .....	40
15.4.1	PM-2X4S Stand Assembly – Exploded View .....	42
15.4.2	PM-2X4S Stand Assembly – Parts List .....	42
16.0	Electrical Connections for CNC Router .....	43
16.1	Main circuit diagram – model PM-2X2R only .....	43
16.2	Main circuit diagram – model PM-2X4SP only .....	44
16.3	7-Pin Cable Connector .....	45
16.4	26-Pin Cable Connector .....	46
16.5	Handheld controller connections .....	47
16.6	Patch board connections .....	48
16.7	Patch board I/O descriptions .....	49
17.0	Warranty and service .....	54

# 4.0 CNC router features

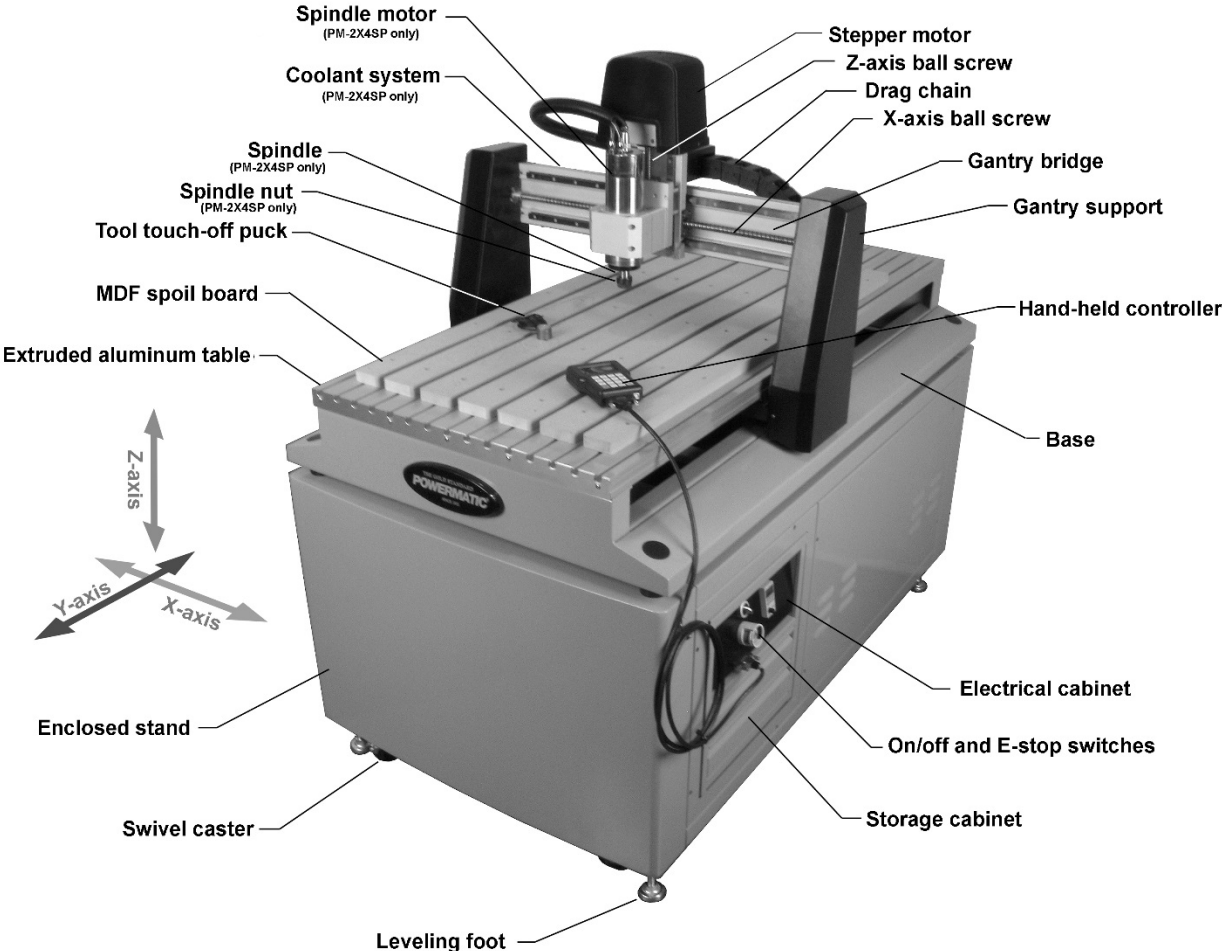

Figure 4-1: features (PM-2X4SP shown)

## 5.0 Specifications for Powermatic CNC Router Machines

Model number	PM-2X2R	PM-2X4SP
<b>Stock numbers</b>		
CNC with stand	1797022K	1797024K
CNC only	1797022B	1797024B
Stand only	1797022S	1797024S
<b>Motor and electricals</b>		
Power requirements	115V, 50~60Hz, 15A <sup>1</sup> , 1 Phase	220V, 50~60Hz, 10A <sup>1</sup> , 1 Phase
Router	Not included (use 3-1/2" or universal)	Spindle router included
<b>Travel</b>		
X-axis travel, max.	24 in. (610 mm)	24 in. (610 mm)
Y-axis travel, max.	24 in. (610 mm)	48 in. (1220 mm)
Z-axis travel, max.	6 in. (153 mm)	6 in. (153 mm)
<b>Spindle</b>		
Collet	n/a	ER20
Collet chuck	n/a	1/4 and 1/2 in.
High speed spindle	n/a	3HP (2.2kW), 7.5A
Spindle speed	n/a	0 – 24000 RPM
Integrated coolant system	n/a	Forced cooling
Recommended coolant	n/a	RV winterizing (pink)
Tool touch off puck	included	included
Dust collection capacity	Minimum 300 CFM	Minimum 300 CFM
Maximum weight of router	8 kg (17.6 lb.)	n/a
<b>Controller</b>	RichAuto B11 DSP CNC motion control system	
	Liquid crystal display, 128x64 resolution	
	Supports standard G-code, PLT format instructions; domestic and international mainstream CAM software, such as Vectric, Type3, Art cam, UG, Pro/E, Master CAM, Cimatron, Ucamcam.	
	Supplied with USB communications port (FAT32), file transfer efficiency can be directly read U disk, card reader file, Plug and Play.	
	256MB internal storage	
<b>Main materials</b>		
Working table	High rigidity aluminum extrusion	
Gantry bridge	High rigidity aluminum extrusion	
Gantry supports	Gravity cast aluminum alloy	
Machine base	All welded steel frame	
Spoil board	MDF	
Stand	Steel	
<b>Table</b>		
Table work area	39.17 x 28.39 in. (995 x 721 mm)	62.99 x 28.39 in. (1600 x 721 mm)
<b>Feed rate</b>		
Rapid feed rate	200 IPM (5 M/min)	200 IPM (5 M/min)
Precision linear guideway	X/Y/Z	X/Y/Z
Precision ballscrew	X/Y/Z	X/Y/Z
<b>Dimensions</b>		
Floor space required	52 W x 45 L in. (1321 x 1143 mm)	52 W x 69 L in. (1321 x 1753 mm)
Machine height	63 in. (1600 mm)	63 in. (1600 mm)
Gantry clearance	6.5 in. (165.1 mm)	6.5 in. (165.1 mm)



<b>Weights</b>		
CNC machine	244 lb. (111 kg)	330 lb. (150 kg)
CNC machine + stand	598 lb. (272 kg)	748 lb. (340 kg)

<sup>1</sup> *subject to local/national electrical codes.*      *n/a = not applicable*

The specifications in this manual were current at time of publication, but because of our policy of continuous improvement, Powermatic reserves the right to change specifications at any time and without prior notice, without incurring obligations.

## 6.0 Glossary

**CAD** – Computer aided design

**CAM** – Computer aided manufacturing

**CNC** – Computer numerical control

**Climb cut** – Cutter rotates with direction of feed. Climb cutting prevents tearout, but can lead to chatter marks with a straight-fluted bit; a spiral-fluted bit will reduce chatter.

**Conventional cut** – Cutter rotates against direction of feed. Results in minimal chatter but can lead to tearout in certain woods.

**Feed rate** – Speed at which the cutting tool moves through the workpiece.

**G-Code** – A universal numerical control (NC) machine tool language that specifies axis points to which the machine will move.

**Grid** – The minimum movement, or feed, of the router head. Head automatically moves to next grid position when button is toggled in continuous or step mode.

**Home position (or machine zero)** – Machine-designated zero point determined by physical limit switches. (It does not identify actual work origin when processing a workpiece.)

**LCD** – Liquid crystal display (used on the controller).

**PLT (or HPGL)** – Standard language for printing vector-based line drawings, supported by CAD files.

**Spindle speed** – Rotational speed of cutting tool (RPM).

**Step down** – Distance in Z-axis that the cutting tool plunges into the material.

**Step, or stepper, motor** – A DC motor that moves in discrete steps by receiving signals, or “pulses” in a particular sequence, thus resulting in very precise positioning and speed control.

**Step over** – Maximum distance in X or Y axis that cutting tool will engage with uncut material.

**Subtractive method** – Router bit removes material to create shapes. (Opposite of additive method.)

**Toolpath** – User-defined, coded route which the cutter follows to machine the workpiece. A “pocket” toolpath cuts the surface of the workpiece; a “profile” or “contour” toolpath cuts completely through to separate the workpiece shape.

**U disk** – External data storage device that is inserted into a USB interface.

**Work origin (or work zero)** – The user-designated zero point for the workpiece, from which the router head will perform all its cutting. X, Y and Z axes are set to zero.

## 7.0 Setup and assembly

### **⚠WARNING**

Read and understand all assembly and setup instructions before attempting assembly. Failure to comply may cause serious injury.

### 7.1 Shipping contents for PM-2X2R

Bold text is how each part is identified in assembly instructions.

BOX #1 – Stand assembly, contains:

See Figures 7-1 and 7-2.

- 4 Cross braces – **S1**
  - 2 Lower supports – **S2**
  - 1 Front panel – **S3**
  - 1 Rear panel – **S4**
  - 1 Left side panel – **S5**
  - 1 Right side panel – **S6**
  - 1 Open side panel – **S7**
  - 4 Swivel casters – **S8**
  - 4 Leveling foot – **S9**
  - 4 Hex nuts – **S10**
- 1 Stand hardware package, p/n **PM2X2S-HP** consists of 3 smaller bags (Figure 20):
    - 16 Hex cap screws M8x25 – **HP001**
    - 16 Lock washers M8 – **HP002**
    - 16 Flat washers M8 – **HP003**
    - 16 Hex cap screws M6x12 – **HP004**
    - 16 Lock washers M6 – **HP005**
    - 16 Flat washers M6 – **HP006**
    - 1 Hook – **HP007**
    - 2 Machine screws M4x6 – **HP008**

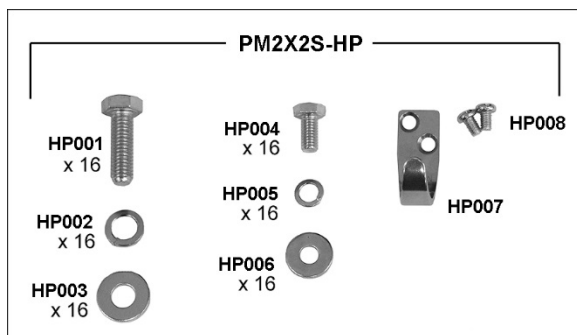

Figure 7-2: stand hardware package

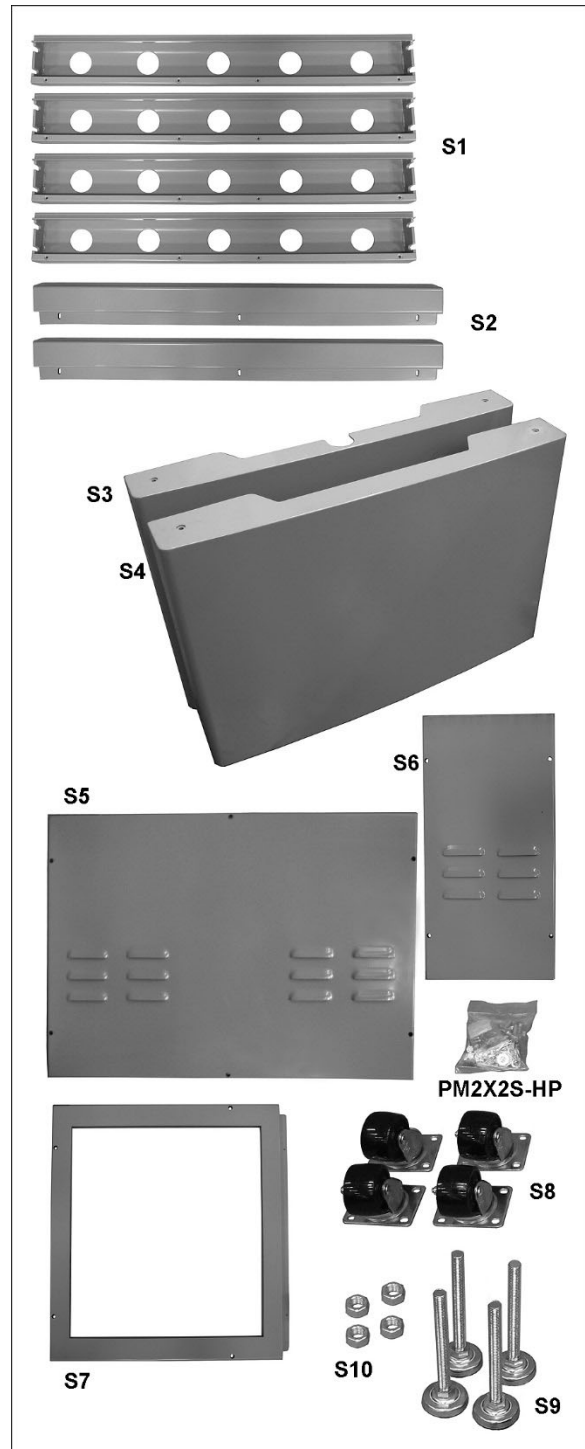

Figure 7-1: PM-2x2R stand contents (not to scale)

BOX #2 – Router table assembly, contains:

See Figures 7-3 and 7-4.

- 1 Router table assembly – **R1**
- 1 Electrical box – **R2**
- 1 Tool cabinet – **R3**
- 1 Controller cable – **R4**
- 1 Front holder – **R5**
- 1 Tool touch-off puck – **R6**
- 1 Step motor – **R7**
- 1 Controller – **R8**
- 1 Top guard – **R9**
- 4 Hold-downs – **R12**
- 1 Dust shoe – **R13**
- 1 Instructions and Parts Manual (not shown)
- 1 Warranty card (not shown)

3 Hardware packages:

**PM2X2R-HP1**

- 20 Soc hd cap screws M5x12 – **HP020**
- 4 Plastic caps – **HP021**

**PM2X2R-HP2**

- 4 Soc hd cap screws M6x35 – **HP022**

**PM2X2R-HP3**

- 4 Rubber foot pads – **HP023**
- 4 Hex cap screws M10x45 – **HP024**
- 4 Flat washers M10 – **HP025**

## 7.2 Unpacking and cleanup

1. Remove all contents from shipping carton. Do not discard carton or packing material until machine is assembled and running satisfactorily.
2. Inspect contents for shipping damage. Report damage, if any, to your shipping agent and distributor.
3. Compare contents of shipping carton with the contents list in this manual. Report shortages, if any, to your distributor.

## 7.3 Tools required for assembly

The following tools are not provided:

- Forklift, or hoist with straps
- #2 cross-point screwdriver
- 10mm, 13mm, 17mm sockets with ratchet wrench and extension
- 24mm open end wrench
- 2mm and 3mm hex keys
- Rubber mallet
- Level



Figure 7-3: PM-2x2R table contents (not to scale)



Figure 7-4: additional accessories

## 7.4 Shipping contents for PM-2X4SP

**⚠WARNING** Read and understand all assembly and setup instructions before attempting assembly. Failure to comply may cause serious injury.

Bold text is how each part is identified in assembly instructions.

BOX #1 – Stand assembly, contains:

See Figures 7-5 and 7-6.

- 4 Cross braces – **S1**
  - 2 Lower supports – **S2**
  - 1 Front panel – **S3**
  - 1 Rear panel – **S4**
  - 1 Left side panel – **S5**
  - 1 Right side panel – **S6**
  - 1 Open side panel – **S7**
  - 4 Swivel casters – **S8**
  - 4 Leveling feet – **S9**
  - 4 Hex nuts – **S10**
- 1 Stand hardware package, p/n **PM2X2S-HP** consists of 3 smaller bags (Figure 6-5):
- 16 Hex cap screws M8x25 – **HP001**
  - 16 Lock washers M8 – **HP002**
  - 16 Flat washers M8 – **HP003**
  - 16 Hex cap screws M6x12 – **HP004**
  - 16 Lock washers M6 – **HP005**
  - 16 Flat washers M6 – **HP006**
  - 1 Hook – **HP007**
  - 2 Machine screws M4x6 – **HP008**

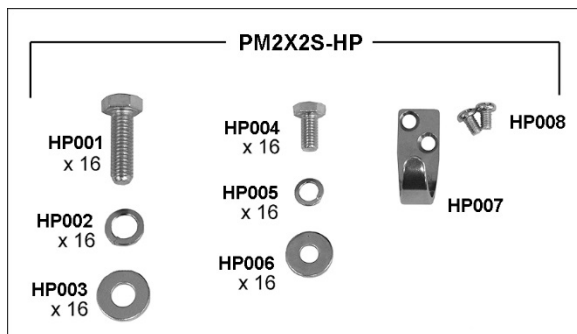

Figure 7-6: stand hardware package

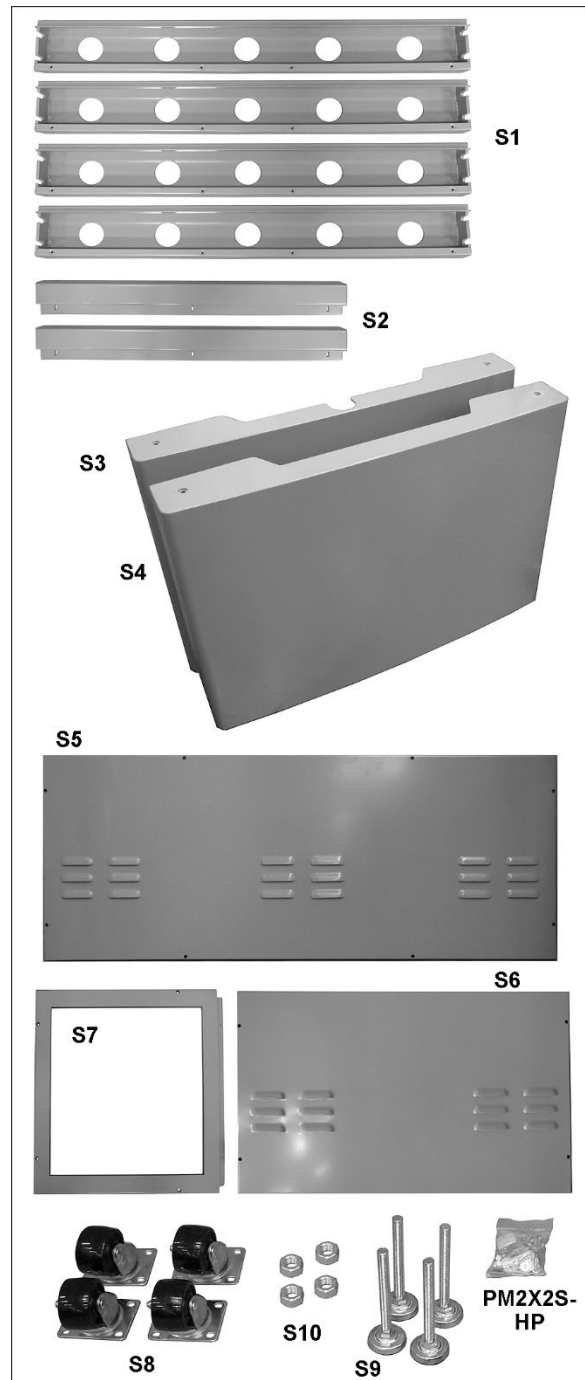

Figure 7-5: PM-2x4SP stand contents (not to scale)

BOX #2 – Router table assembly, contains:

See Figures 7-7 and 7-8.

- 1 Router table assembly – **R1**
- 1 Electrical box – **R2**
- 1 Tool cabinet – **R3**
- 1 Controller cable – **R4**
- 1 Tool touch-off puck – **R6**
- 1 Step motor – **R7**
- 1 Controller – **R8**
- 1 Top guard – **R9**
- 2 Spindle wrenches – **R10**
- 1 ER20 Collet – **R11**
- 4 Hold-downs – **R12**
- 1 Dust shoe – **R13**
- 1 Instructions and Parts Manual (not shown)
- 1 Warranty card (not shown)

3 Hardware packages:

**PM2X2R-HP1**

- 20 Soc hd cap screws M5x12 – **HP020**
- 4 Plastic caps – **HP021**

**PM2X2R-HP2**

- 4 Soc hd cap screws M6x35 – **HP022**

**PM2X2R-HP3**

- 4 Rubber foot pads – **HP023**
- 4 Hex cap screws M10x45 – **HP024**
- 4 Flat washers M10 – **HP025**

**7.5 Unpacking and cleanup**

1. Remove all contents from shipping carton. Do not discard carton or packing material until machine is assembled and running satisfactorily.
2. Inspect contents for shipping damage. Report damage, if any, to your shipping agent and distributor.
3. Compare contents of shipping carton with the contents list in this manual. Report shortages, if any, to your distributor.

**7.6 Tools required for assembly**

The following tools are not provided:

- Forklift or hoist
- #2 cross-point screwdriver
- 10mm, 13mm, 17mm sockets with ratchet wrench and extension
- 24mm open end wrench
- 2mm and 3mm hex keys
- Rubber mallet
- Bubble level



Figure 7-7: PM-2x4SP table contents (not to scale)



Figure 7-8: additional accessories

## 7.7 Assembling stand (all models)

NOTE: Assembly procedures for stand are identical for PM-2X2R and PM-2X4SP. The only difference is side panels and braces are longer on the 2X4 model.

1. Thread a nut (S10) onto each leveling foot (S9, Figure 7-9).
2. Turn front and rear panels upside down. You may wish to lay down a rug or cardboard to prevent scratching top surface of panels.
3. Install four leveling feet and four casters into bottom of panels, as shown. Tighten caster screws securely. The leveling feet can be adjusted later.

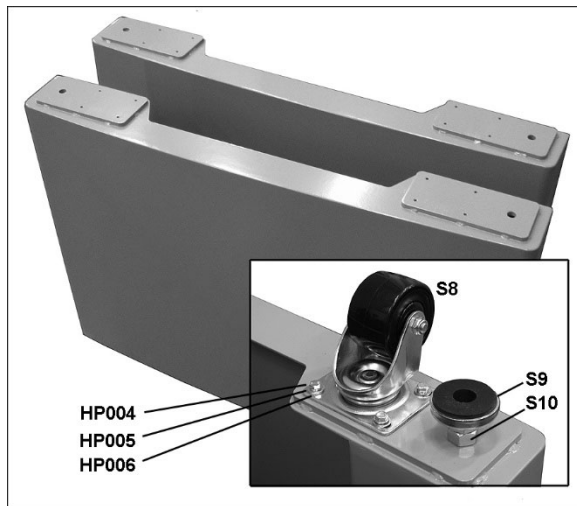

Figure 7-9

4. Partially insert eight screws with washers (Figure 7-10) into threaded holes inside both panels. Push washers against screw head.
5. Install cross braces over screws, and tighten. NOTE: The flange on the cross brace must face toward the outside. (TIP: Use rubber mallet to tap cross braces even with panel edges.)

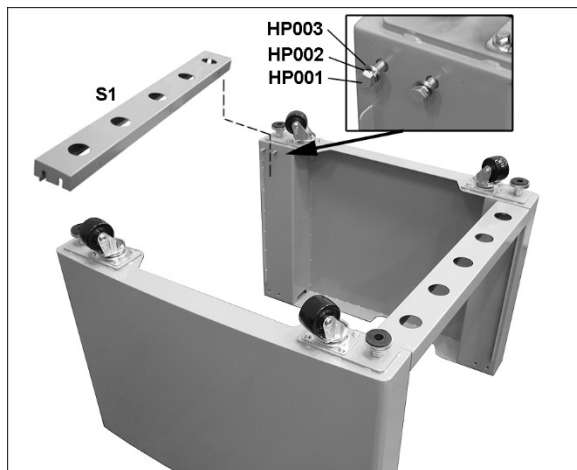

Figure 7-10

6. Flip assembly on its side, and install a third cross brace in similar manner (Figure 7-11). Tighten screws.
7. Flip assembly again (right side up) and install fourth cross brace. Tighten screws.

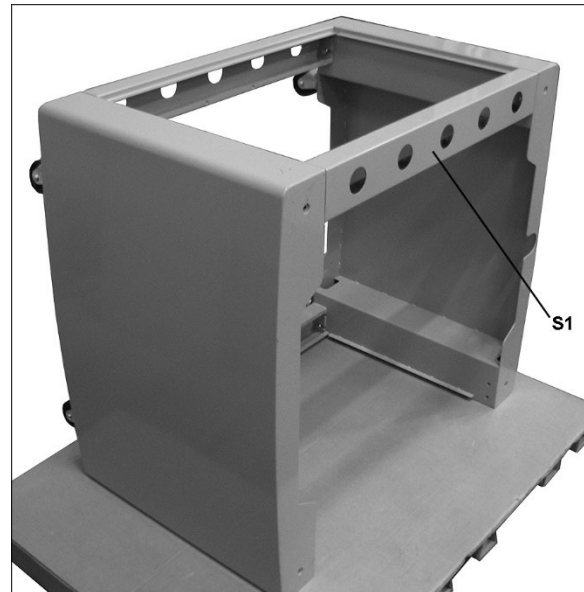

Figure 7-11

8. Install lower supports (S2, Figure 7-13) to bottom of assembly. Figure 7-12 shows orientation of lower supports and how tool cabinet will rest upon them.

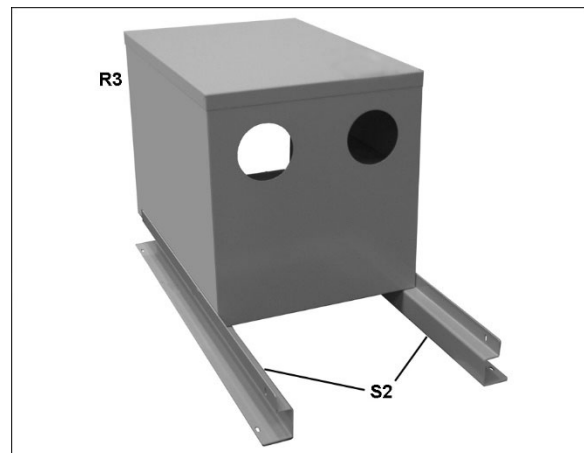

Figure 7-12

9. Install open side panel (S7, Figure 7-13) and tighten screws.
10. Place tool cabinet (R3) into stand so it is flush with side panel (S7). See Figure 7-13. Use double-sided foam tape to secure tool cabinet to lower supports.

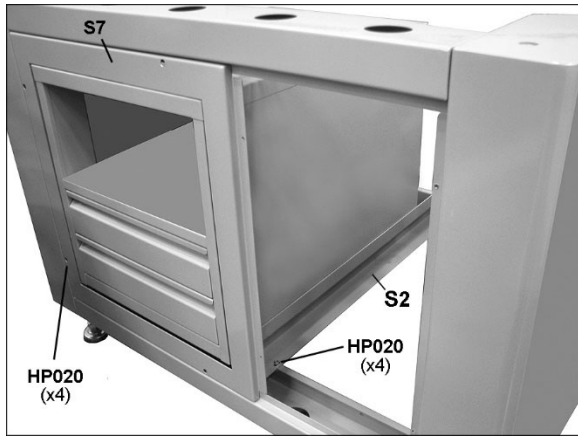

Figure 7-13

11. Slide electrical cabinet (R2) into opening, while feeding the attached cables through rear holes (Figure 7-14).
12. Install louvered side panel (S6).



Figure 7-14

13. Install remaining side panel (S5, Figure 7-15). The stand is now complete.
14. Rest the server cables through slot on rear panel (X, Figure 7-15). Feed the electrical cable underneath stand so that plug can be accessed after installing router table.

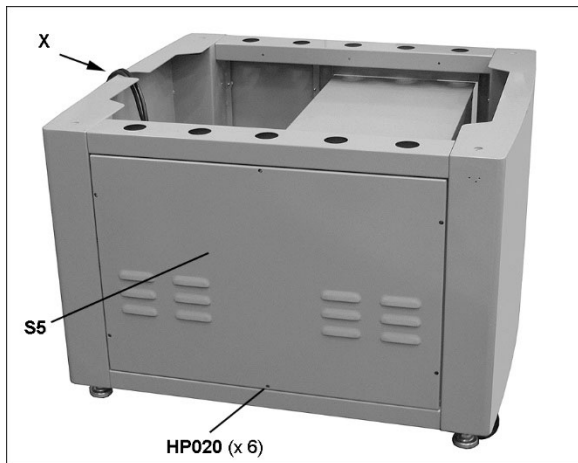

Figure 7-15

## 7.8 Installing router table on stand

**⚠WARNING** Router table assembly is heavy; use forklift, hoist or other secure means to lift.

**⚠CAUTION** Never lift router table by the gantry or damage to machine may occur. Keep straps or forks away from any parts that could be damaged during lifting.

### 7.8.1 Lifting with forklift

1. Place a scrap block beneath router assembly to hold it up, and slide forks carefully beneath router table base (Figure 7-16). Make sure forks are long enough to extend past opposite end of table. Raise router table.

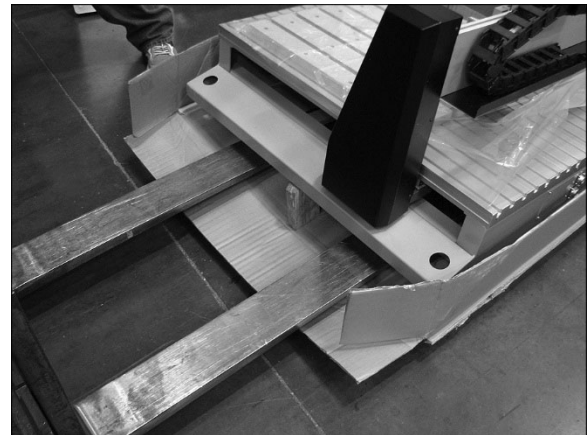

Figure 7-16

2. Place rubber foot pads (HP023, Figure 7-17) over holes in stand.
3. Lower router table assembly while aligning holes in router assembly and stand. Make sure table assembly is properly oriented to stand.
4. Insert four screws with flat washers (HP024/025) loosely to ensure hole alignment. Remove forks and tighten screws.
5. Place a level on the aluminum table and level table in all directions, adjusting the leveling feet as needed.

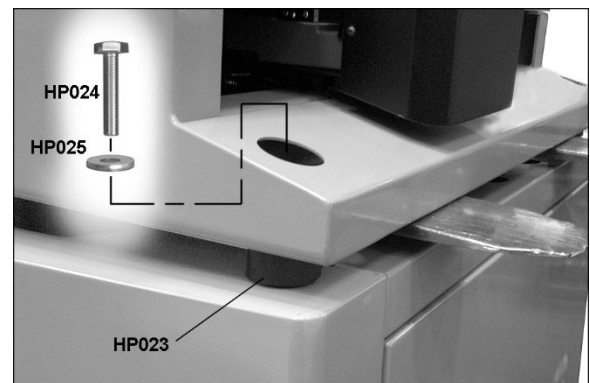

Figure 7-17

## 7.8.2 Lifting with hoist

1. Place straps around steel bolts, and put bolts inside the four holes (X, Figure 7-18). **Make sure bolts are long enough to span hole and catch beneath base, and that straps will tighten clear of gantry and any fragile parts.**
2. Place rubber foot pads (HP023, Figure 7-17) over holes in stand.
3. Lower router assembly while aligning holes in router assembly and stand.
4. Remove straps and insert four screws with flat washers (HP024/025, Figure 7-17) loosely to ensure hole alignment. Tighten screws.
5. Level the router table along both axes, adjusting the levelers below the stand as needed.

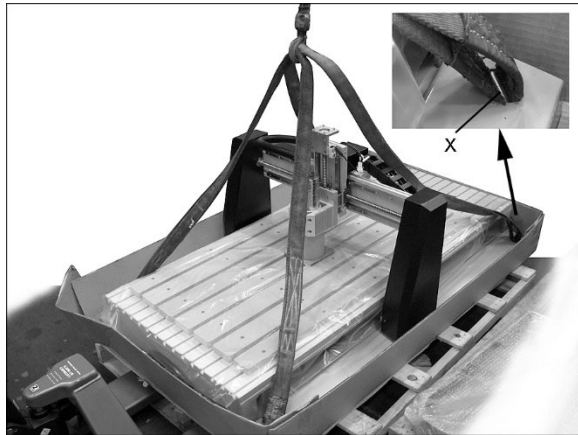

Figure 7-18

## 7.9 Completing assembly

1. Push cable connectors into their corresponding receptacles (Figure 7-19) and rotate collars to secure.



Figure 7-19

2. Position power cord from beneath stand so it will not be tread upon or rolled over by the casters.
3. Install hook (HP007) onto threaded holes in left or right side of stand (Figure 7-20). Connect cable (R4) to server and controller.



Figure 7-20

4. Install plastic caps (HP021) over holes in table base.
5. Install step motor (R7, Figure 7-21) to top of gantry tower in the orientation shown, and tighten two setscrews in coupling (Y). Connect cable.
6. The tool touch-off puck plugs into socket on gantry support (Figure 7-21).

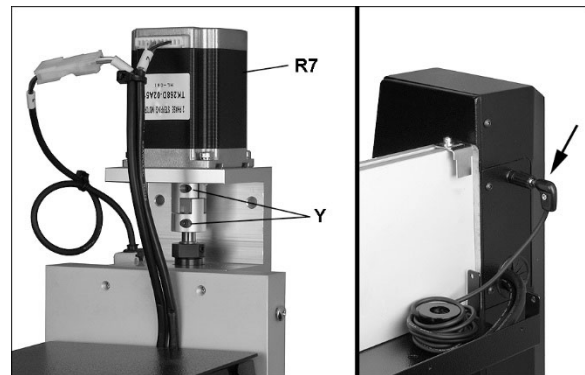

Figure 7-21

## 7.10 Installing router (PM-2X2R only)

Secure a router (not included) into the holder as shown, Figure 7-22. The machine will accept a 3-1/2" or universal router. Orient the speed dial toward front of machine if possible. Make sure screws are securely tightened. **NOTE: Maximum weight of router = 8 kg. (17.6 lb.)**

Position power cable so it will not interfere with vertical or horizontal movement of head. See Figure 7-23. Optimal method is to feed plug through box (A) and drag chain (B), and connect to receptacle (C) in the tray. Keep excess length of cable inside box, as shown (cable ties not included.)



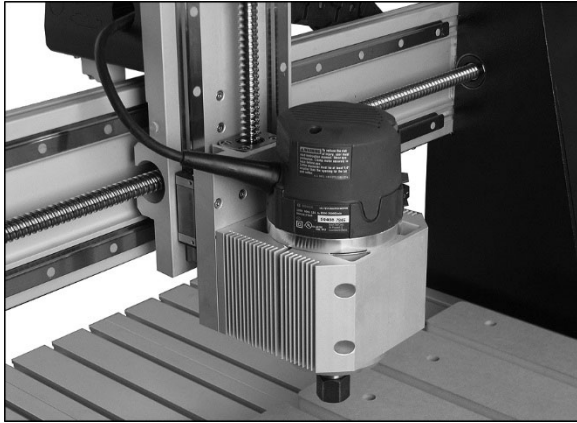

Figure 7-22 (PM-2X2R only)

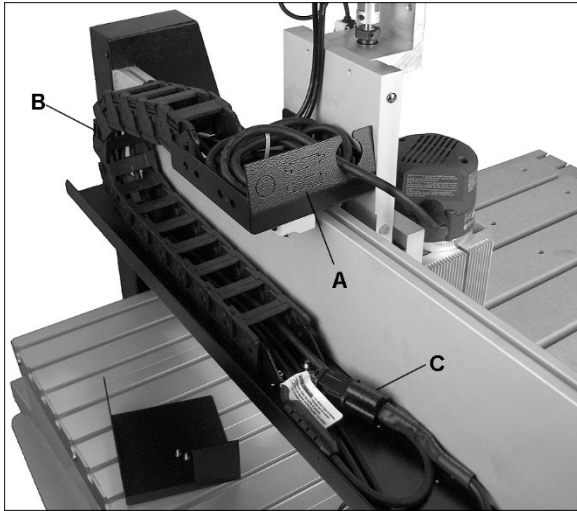

Figure 7-23 (PM-2X2R only)

### 7.11 Installing top guard

Slide top guard over two screws on gantry head (Figure 7-24) and tighten with screwdriver through the outer holes.

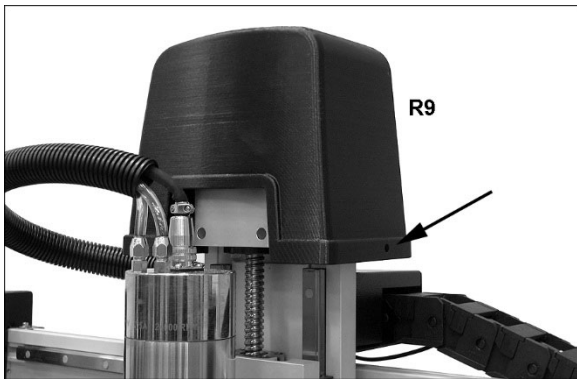

Figure 7-24

## 8.0 Electrical connections

**⚠WARNING** All electrical connections must be done by a qualified electrician in compliance with all local codes and ordinances. Failure to comply may result in serious injury.

The **PM-2X2R** Router is rated at 115V power. The router comes with a plug designed for use on a circuit with a *grounded outlet* that looks like the one pictured in **A**, Figure 8-1. It is recommended that the PM-2X2R router be connected to a dedicated 15-amp circuit with circuit breaker or time-delay fuse marked "D". **Local codes take precedence over recommendations.**

The **PM-2X4SP** Router is rated at 220V power. The router comes with a plug designed for use on a circuit with a *grounded outlet* that looks like the one pictured in **D**, Figure 8-1. It is recommended that the PM-2X4SP router be connected to a dedicated 10-amp circuit with circuit breaker or time-delay fuse marked "D". **Local codes take precedence over recommendations.**

Before connecting to power source, be sure switch is in *off* position.

### 8.1 GROUNDING INSTRUCTIONS

1. All Grounded, Cord-connected Tools:

This machine must be grounded. In the event of a malfunction or breakdown, grounding provides a path of least resistance for electric current to reduce the risk of electric shock. This tool is equipped with an electric cord having an equipment-grounding conductor and a grounding plug. The plug must be plugged into a matching outlet that is properly installed and grounded in accordance with all local codes and ordinances.

Do not modify the plug provided - if it will not fit the outlet, have the proper outlet installed by a qualified electrician.

Improper connection of the equipment-grounding conductor can result in a risk of electric shock. The conductor with insulation having an outer surface that is green with or without yellow stripes is the equipment-grounding conductor. If repair or replacement of the electric cord or plug is necessary, do not connect the equipment-grounding conductor to a live terminal.

**⚠WARNING** Check with a qualified electrician or service personnel if the grounding instructions are not completely understood, or if in doubt as to whether the tool is properly grounded. Failure to comply may cause serious or fatal injury.

Use only 3-wire extension cords that have 3-prong grounding plugs and 3-pole receptacles that accept the tool's plug.

Repair or replace damaged or worn cord immediately.

2. Grounded, cord-connected tools intended for use on a supply circuit having a nominal rating **less than 150 volts**:

This tool is intended for use on a circuit that has an outlet that looks like the one illustrated in **A**, Figure 8-1. An adapter, shown in **B** and **C**, may be used to connect this plug to a 2-pole receptacle as shown in **B** if a properly grounded outlet is not available. The temporary adapter should be used only until a properly grounded outlet can be installed by a qualified electrician. The green-colored rigid ear, lug, and the like, extending from the adapter must be connected to a permanent ground such as a properly grounded outlet box. **Note: In Canada, the use of a temporary adaptor is not permitted by the Canadian Electrical Code, C22.1.**

3. Grounded, cord-connected tools intended for use on a supply circuit having a nominal rating between **150 - 250 volts**, inclusive:

This tool is intended for use on a circuit that has an outlet that looks like the one illustrated in **D**, Figure 8-1. The tool has a grounding plug that looks like the plug illustrated in **D**. Make sure the tool is connected to an outlet having the same configuration as the plug. No adapter is available or should be used with this tool. If the tool must be reconnected for use on a different type of electric circuit, the reconnection should be made by qualified service personnel; and after reconnection, the tool should comply with all local codes and ordinances.

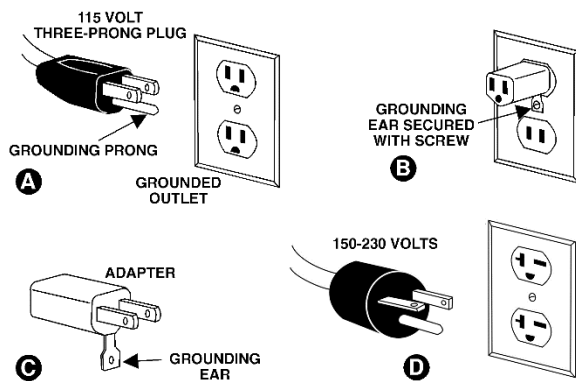

Figure 8-1

## 8.2 Extension cords

The use of extension cords is discouraged; try to position machines near the power source. If an extension cord is necessary, make sure it is in good condition. When using an extension cord, be sure to use one heavy enough to carry the current your product will draw. An undersized cord will cause a drop in line voltage resulting in loss of power and overheating. Table 1 shows correct size to use depending on cord length and nameplate ampere rating. If in doubt, use the next heavier gauge. The smaller the gauge number, the heavier the cord.

Ampere Rating		Volts	Total length of cord in feet			
More Than	Not More Than		25	50	100	150
		120	25	50	100	150
		240	50	100	200	300
			AWG			
0	6		18	16	16	14
6	10		18	16	14	12
10	12		16	16	14	12
12	16		14	12	Not Recommended	

Table 1: Extension cord recommendations

## 9.0 Setup for operation

### 9.1 Spoil board preparation

The sacrificial, or “spoil,” board prevents damage to the cutter as it cuts through the work material. A spoil board must be flat and smooth.

The CNC router table is provided with 1-inch thick MDF spoil board strips. An initial fly cut is strongly recommended to remove any marks and create a perpendicular surface to the cutting path. Cut only the minimal amount to create a flat surface (0.020 inch recommended).

**(NOTE:** A pre-set program is available for flycutting your spoil board with a 1-1/2 inch flycutting bit. Contact Powermatic customer support to download.)

Workpieces may be secured to spoil board using hold-downs (provided) in the table T-slots, if the outer edges of workpiece are not being machined (Figure 9-1). Additional hold-downs (p/n 1797000, set of 2) are available from Powermatic.

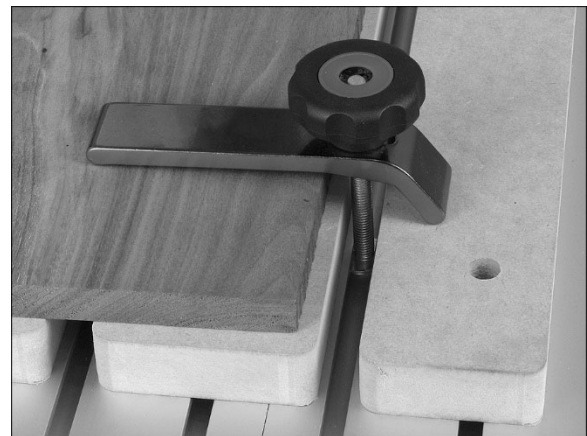

Figure 9-1: optional clamping method

Alternatives include drilling the work directly to the spoil board, or securing it using double-sided tape. Make sure spoil board is clean and no chips or sawdust are beneath the tape. The finished workpiece can be removed from the board using a wide putty knife or similar tool.

**CAUTION:** Do not spill liquids onto the spoil board, as it may cause warpage.

## 9.2 Spindle setup (PM-2X4SP only)

**WARNING** Disconnect machine from power source during the following procedures.

1. Remove cover from gantry box, and check coolant level. Top off if needed with distilled water.

**CAUTION** Low or absent coolant will overheat spindle and cause damage to machine. Maintain coolant level.



Figure 9-2

2. Remove spindle nut from spindle.
3. Make sure provided collet is clean, and insert it into spindle nut (Figure 9-3). Press until it snaps into position.

(To remove collet from nut, remove cutter/bit, hold spindle nut and press collet from the side. Collet will come out.)

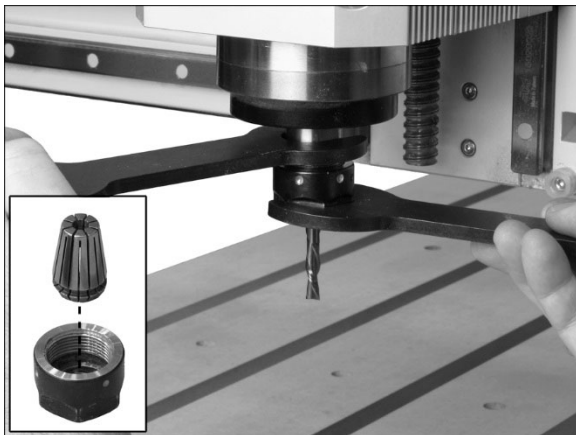

Figure 9-3

4. Thread nut with collet onto spindle.
5. Insert bit into collet. (A bit set is available from Powermatic, p/n 1797003.) Flute of bit should extend at least 1/16-inch from collet. Tighten bit by holding one wrench on spindle flats and turning nut with second wrench, as shown. **Do not overtighten.**

## 9.3 Router bit selection

Bits are available in many styles and number of flutes, and are chosen depending upon the wood used and the cutting process desired.

Straight bits can have one or more flutes. Spiral bits are available in up-cut, down-cut, or compression form. "Insert" bits have removable blades for resharpening or replacement. V-bits (or "v-groove" or "engraving" bits) have angled sides leading to the point, useful for creating a sharp, grooved bottom in lettering and sign making. A spoil board cutter (or "flycutter bit") is ideal for making a workpiece surface flat or re-surfacing the spoil board. Many specialty bits are also made for specific applications.

Cutter manufacturers provide a recommended feed and speed rate for their bits, or a "chipload" (physical size of chips produced by the bit when making a cut). Formula is:

$$\text{chipload} = \frac{\text{feed rate}}{\text{RPM} \times \text{number of flutes}}$$

An up-cutting, two-flute spiral bit is a good general-purpose tool for making straight cuts in plywood.

Router bit shank size should match the capacity of the collet used.

## 9.4 Dust collection

A dust collection system (not provided) should be connected to the CNC router via a dust shoe mounted below the spindle. At least 300 CFM collection capacity is recommended.

A dust shoe (p/n 1797001) is provided with your machine. Slide it up onto router housing and tighten screw. Support weight of dust hose when connected to dust shoe.

**IMPORTANT:** When mounted, do not allow bristles to press hard against table, or they may be damaged. When not in use, remove dust shoe from spindle, and store without pressure on bristles.

## 10.0 Operations

**WARNING** Always turn off machine when changing cutters or working on spindle.

### 10.1 Controller overview

Tool paths are communicated to the router via the handheld controller. Processing jobs is done in one of two ways: from internal memory or from a U disk inserted into the interface. (Figure 10-1).

Use of internal memory is recommended for frequently used job files.

The key pad uses single-touch as well as combination keys (press two keys at same time) to effect commands.



Figure 10-1

## 10.2 Inverter (PM-2X4SP only)

The inverter on the model PM-2X4SP maintains spindle speed. The display shows RPM (1000 RPM per pulse); turn knob to adjust. See Figure 10-2.



Figure 10-2

The STOP button will stop the spindle during operations. However, it is recommended that any process be stopped using the controller, instead of the STOP button on the inverter.

## 10.3 Operating procedure

Operations may be done *manually*, through the controller keypad, or *automatically*, through the design file downloaded through the controller via U-disk or internal memory.

1. Make sure levelers beneath stand have been lowered to floor to prevent machine from rolling.
2. Make sure workpiece is secured to table using clamps or double-sided tape.
3. Release E-stop button by rotating clockwise.

4. Turn on machine by rotating green switch. The controller will also turn on and display screen will light up. Allow system to completely boot.

NOTE: The machine must be homed before performing any other function. See sect. 10.4.

5. In Home position, head will be in accessible position to insert cutting bit. **Switch off machine** and install bit securely in collet. Restart machine.

Note: During gantry movement, observe drag chain beneath table. If it has tendency to catch on cross brace, lift it slightly to clear.

## 10.4 HOME position (machine origin)

When machine is started, controller display will show prompt requesting Home (Figure 10-3).

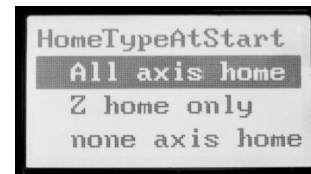

Figure 10-3

Home position is determined by actual limit switches on the machine, and will not change. However, **it is important that the machine be homed before each distinct operation** to ensure that settings and limit switches are properly functioning. All movements are based upon these Home position limit switches.

1. Press **HOME**. Spindle will move to Home position, generally front left corner of table.
2. Press **OK** and spindle will move to work origin. (see sect. 10.6 to set work origin).

After normal shut-down of the machine, if you start up and continue the previous operation, homing will not be necessary as the system will have saved the last coordinate values. Select “none axis home.”

## 10.5 Moving router head

Router head can be moved manually in one of 3 ways. Press **MODE** to toggle between selections.

The system uses a grid, or minimum feed, concept to assist processing accuracy. The range is 0.05mm to 1.0mm. In continuous or step mode, the router head will move to next grid if button is toggled.

1. *Continuous mode*: Hold down **X+/-**, **Y+/-**, or **Z+/-** button and head will move until button is released. Screen displays location of router head as it moves. If button is held less than 1/2 second, machine will move to nearest grid. **FAST/SLOW** button determines speed of movement. Machine will always stop on grid at end of continuous motion.

2. *Step mode*: Press **X** or **Y** button to move router head in increments, useful for precise adjustment of coordinates and tool. Low speed is default, one grid per 1/2 second. Press **FAST/SLOW** button to select either 0.5mm (high) or 0.1mm (low) travel distance per step.
3. *Distance mode*: Input a set distance to which the router head will move. Hold down **X+/-**, **Y+/-** or **Z+/-** button and head will move until distance is reached. Note: Machine will not move to grid in this mode. To change distance, triple press **MODE** and enter new value.

## 10.6 Setting work origin

NOTE: Work origin can only be set under workpiece coordinate system, not machine coordinate system.

Work origin establishes the zero point from which the router will perform the cutting process, and is dependent upon size and design of workpiece. Work origin should match the zero point of your uploaded part drawing.

**CAUTION** Work origin must be set before operation, unless repeating the same operation. Failure to properly set Z-axis origin may result in damage to router table and cutting tool.

1. Make sure cutting bit is secured within collet.
2. Move spindle to desired location using X and Y buttons.
3. Press **XY-0** to set origin at this location for X and Y-axes.
4. Set Z-axis origin with provided tool touch-off puck (Figure 10-4), as follows:

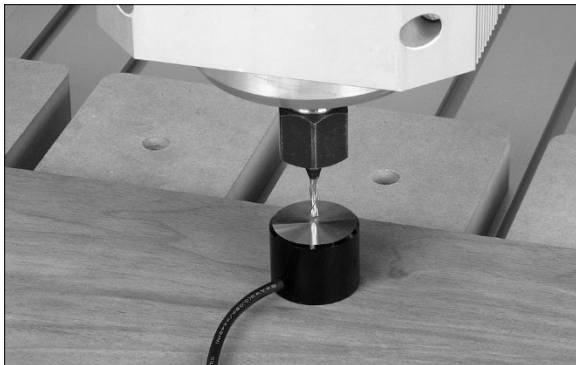

Figure 10-4

5. Insert puck pin adaptor into receptacle, and center puck under cutting tool, **on top of workpiece**.

**CAUTION** Z-axis origin must be set relative to top of work material to prevent cutting through work table.

6. Press **MENU + SPINDLE**. Spindle will slowly lower until it contacts puck, then will return to raised position. Z-axis origin is now stored in

system. (System automatically deducts the 1-inch thickness of puck when registering touch point.)

NOTE: To set Z-axis origin without touch-off puck, place controller in step mode, and slowly lower spindle, while rotating spindle by hand. When you feel resistance as bit contacts workpiece, this will be your Z-axis origin.

7. Controller display will now show work origin zero on three axes. Figure 10-5 shows parameters stored in **MENU + 1** location.

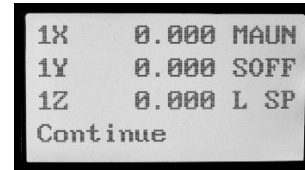

Figure 10-5

When machine is restarted, then Homing process is done, press **OK** and machine will return to work origin point.

Note; Additional work origins can be stored (identified on screen as 2X,2Y,2Z; 3X,3Y,3Z, etc.). See sect. 11.0.

## 10.7 Processing a file

IMPORTANT: After copying files from computer to a U-disk, always select "Eject" to safely remove disk from computer; otherwise controller may not recognize the U-disk when inserted.

1. Press **RUN/PAUSE** to select file.
2. Use **▲** or **▼** buttons to select either U Disk file or internal memory file.
3. Press **OK** to select. First three files will be displayed.
4. Use **▲** or **▼** buttons to move cursor (or **Y+** and **Y-** to jump two lines). Select file.
5. The file parameters will be displayed. These are set in the CAD/CAM software, but can also be adjusted using the controller.
6. Press **OK** to begin process. After brief count-down, program will begin. (Spindle will start automatically on both models.)
7. During processing, screen will display current line, current speed, speed ratio and operating time. To switch these options, press **MODE**.

### 10.7.1 Speed ratio adjustment

Speed ratio can be changed during processing. [current speed = set speed x ratio.]

1. Press **Y+** or **Y-** to select.
2. Each **Y-** click decreases speed ratio by 0.1. (Maximum ratio = 1.0; minimum ratio = 0.1.)

3. Screen will display corresponding ratio change, but operating time will not change.

### 10.7.2 Spindle state adjustment

Spindle grade can be changed during processing.

1. Press **Z+** or **Z-** to select.
2. Each **Z+** click increases one grade. Each **Z-** click drops one grade. (Maximum S8; minimum S1.)

### 10.7.3 Pausing

1. Press **RUN/PAUSE**. Machine will stop moving, but spindle remains active.
2. While machine is paused, the bit position can be adjusted on any of the axes.

Default motion is Step mode, default speed is Low; thus machine will move a low speed grid for each click. If wider, more rapid adjustment range is needed, press **FAST/SLOW** to change speed, motion will change to Continuous.

3. After adjustments, press **RUN/PAUSE** to continue process.
4. “*Restore Position?*” prompt will appear.
5. Press **OK** to restore previous settings, or **CANCEL** to continue with your modified settings.

Note: Choosing to save the modified position at the prompt will ensure the process begins at that modified position the next time the process is started.

### 10.7.4 Stopping and breakpoint

1. Press **STOP** to end a process. Spindle will stop moving.
2. “*Save break?*” prompt appears. A breakpoint stores the exact location so user can return to it in a process.
3. Press **OK**.
4. Screen displays breakpoint storage locations 1 through 8. Press **▲** or **▼** to select location, then **OK**.
5. System will automatically Home.
6. To continue processing from your saved breakpoint, press **BREAK/WORK**.

If you wish to fall back from the breakpoint, press **RUN/PAUSE**, input line number, and press **OK**. System will operate from the new line number.

### 10.7.5 Power failure protection

If a power failure occurs during processing, current parameters/coordinates will be saved by the system.

1. When power is restored, machine will make a Home motion.
2. “*Want to Restore?*” prompt appears.
3. Press **OK** to continue unfinished process, or **CANCEL** to cancel process.

## 10.8 Advanced processing

Advanced processing is a function that satisfies a special request. Press **ADVANCED FUNCTION** key to access. Major subheadings include Array Work, Resume Work, and Tool Changing.

### 10.8.1 Array work

Runs multiple processes in order.

1. Press **▲** or **▼** to select file source.
2. Press **OK**.
3. Press **▲** or **▼** to select multiple files.
4. Select process parameters. (Note: These can also be established under **MENU**/Auto Pro Setup/Work Array.)

### 10.8.2 Resume work

1. Press **▲** or **▼** to select “Resume Work.”
2. Press **OK**.
3. Press **▲** or **▼** to select break point (1-8).
4. Press **OK**. System will restore processing from break point.

### 10.8.3 Tool changing

Head will move to convenient position for easy tool changes. Default is home position.

## 10.9 Data restore

If problems arise while using controller, the controller software can be easily restored to original settings using backup data stored on U disk.

1. Press **MENU**.
2. Select *System Setup/Restore Data* and follow the commands.















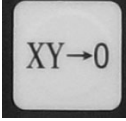



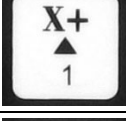
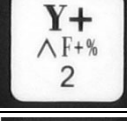
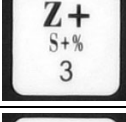

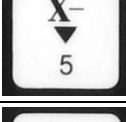
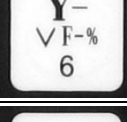
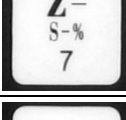
## 10.10 System updates

Upgrades to the software may become available occasionally. Contact Powermatic customer support for downloadable files.

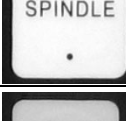
# 11.0 Controller functions

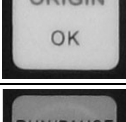
## 11.1 Keypad basic functions

Table 2

Key	Function	Key	Function
	Resumes work from a break point		Stores Z-axis tool setting
	Special function setup		Repeats previous operation
	Set work origin of X- and Y-axis		Establish Z-axis origin
	Function button reserved for system		Function button reserved for system
	X-Axis positive movement from home Menu up Figure 1 input		Y-Axis positive movement from home Increase feed rate Menu page up Figure 2 input
	Z-axis positive movement from table Increase spindle speed Figure 3 input		Figure 4 input
	X-axis negative movement Menu down Figure 5 input		Y-axis negative movement Decrease feed rate Menu page down Figure 6 input
	Z-axis negative movement Decrease spindle speed Figure 7 input		Figure 8 input
	Spindle to home (machine origin) Figure 9 input		Manual movement - high or low speed Figure 0 input
	Spindle start/stop Decimal point input		Menu access Minus symbol input
	All axes move to work origin Confirm commands		Movement selection (continuous, step, or distance)
	Load program/pause while running Delete inputs		Stops running command Cancel commands

## 11.2 Frequent keypad combinations

Press first button and hold, then press second button.

Key combination	Function
OK + MENU	Update file in system
MENU + 0	Machine coordinate system (identified by prefix A)
MENU + (1-9)	Workpiece coordinate system (store up to 9 different systems)
MENU + SPINDLE	Z-axis automatic tool setting
RUN + (1-8)	Begin break processing
RUN + FAST/SLOW	Begin advanced processing (may also used ADVANCED FUNCTION key)
ON/OFF + Z+	Increase spindle speed while working
ON/OFF + Z-	Decrease spindle speed while working
RUN + 9	Repeat last process
MENU + MODE	Enter coordinate parameters
OK + MODE	Power on to U disk mode
OK + C	Help information
OK + STOP	Quick buttons check

Table 3

## 11.3 MENU key hierarchy and description

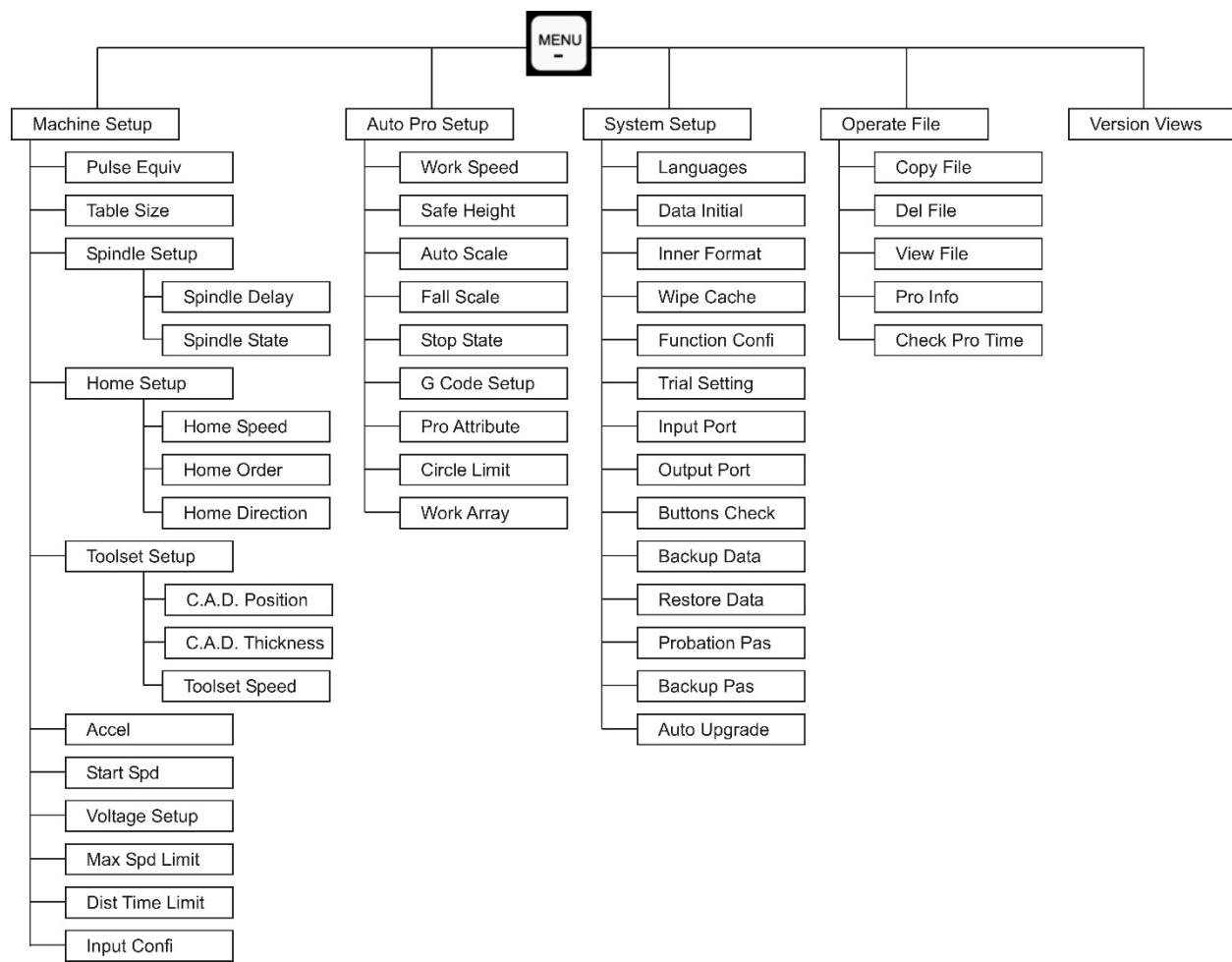

Table 4

NOTE: Not all functions may be applicable to your Powermatic unit.



## MACHINE SETUP

Machine Setup parameters are set by the manufacturer specifically for your CNC routing machine. It is usually unnecessary to change the Machine Setup defaults unless the parameters of the actual machine change.

**Pulse Equivalence** – Number of pulses sent by system to stepper motor for each 1mm of movement (unit: pulse/mm).

$$\text{Stepper driver formula} = \frac{\text{pulses per revolution}}{\text{distance per revolution}} \quad \text{thus ....} \quad \text{Pulse} = \frac{\frac{360^\circ}{\text{Stepper angle}} \times \text{Driver subdivision}}{\text{Screw pitch} \times \text{transmission ratio}}$$

description: Stepper angle is angle of motor parameters, motor rotation step walk.  
Driver subdivision is the parameter set by the driver.  
Screw pitch is distance the nut moves when ball screw makes one rotation.  
Transmission ratio is speed ratio or angular velocity ratio of capstan and driven wheel.

**Table Size** – Preset values; prevents machine over-travel. Verify table size from Specifications.

1. Press ▲ or ▼ key to select.
2. Press **RUN/PAUSE**, and input number.
3. Press **OK** to save.
4. Repeat for Y and Z axis values. Press **OK** to save all values.

**Spindle Delay** – Sets the time at which the spindle starts after reading the file (unit: microseconds).

**Spindle State** – Sets spindle signal control parameters.

**Home Speed** – Sets speed separately for each axis when homing; default is X/Y: 3000 mm/min. and Z: 1800 mm/min.

**Home Order** – Sets desired sequence of axes when homing.

**Home Direction** – Sets each axis for positive or negative direction, based on Home position.

### C.A.D. Position

**C.A.D. Thickness** – Thickness of tool touch-off puck. Z-axis movement is established by the software file, but can be changed here manually.

### Toolset Speed

**Acceleration** – Can be adjusted to improve line and curve motions; default is 800 mm/s<sup>2</sup>.

**Start Speed** – Sets skip speed and completion speed.

**Voltage Setup** – Sets input and output terminal status.

**Max Speed Limit** – Sets maximum speed of head movement; defaults are X/Y: 60,000,000; Z+: 1800, Z-: 3000.

**Distance Time Limit** – Sets period in which machine can sit idle before reverting to continuous mode; default is 30 seconds.

### Input Configuration

## AUTO PRO SETUP

**Work Speed** – Sets work speed (default 6000 mm/min.) and fast speed (default 3000 mm/min.).

**Safe Height** – Z-axis lift height while processing; default is 40.000 mm.

### Auto Scale

**Fall Scale** – Sets fall scale (default 0.200mm) and fall height (default 5.000mm). Fall down scale takes effect when spindle descends to fall height.

**Stop State** – Establishes router head stop position after machine is done. Press **X+/-** to select line; press **RUN/PAUSE** to input desired number, then **OK**.

**G Code Setup** – Sets special code read configuration in G code (e.g. M,T,F,I,J,K).

**Pro Attribute**

**Circle Limit** – Default is 1000.00.

**Work Array** – Sets up array parameter, including column count, row count, column space, row space, and interval (microseconds).

**Toolset Fall**

**SYSTEM SETUP**

**Languages** – default English

**Data Initial** – Restores factory system parameters.

**Inner Format** – Clean up inner files. Will not affect system parameters.

**Wipe Cache** – Cleans up file fragmentation and system errors.

**Function Configuration**

**Probation Password** – 20-digit password available from controller manufacturer.

**Backup Password** – Prevents customer parameters from overwriting original parameters. To cancel backup password, when display shows “Input New Password”, do not enter a password, and press **OK**.

**Input Port**

**Output Port**

**Buttons Check** – Test function of keypad buttons. Screen display when each button is pressed; no display if button is not functioning. Press **OK** to quit.

**Backup Data** – Backs up menu parameters, is not affected by system reformat.

**Restore Data** – Restore backup data to system.

**Trial Setting** – Set up trial passwords and user time.

**Auto Upgrade** – Updates system online. Supports the .pkg file extension. Will not affect system parameters.

**OPERATE FILE**

**Copy File** – Copy files from U disk to internal memory.

**Delete File** – Delete files from internal memory.

**View File** – View files from either U disk or internal memory.

**Processing Info** – Shows number of files successfully processed. Data is cleared when powered off.

**Check Process Time** – Shows time used for processing file(s).

**VERSION VIEWS**

Controller software information; preset by manufacturer.

## 11.4 “Advanced Processing” hierarchy

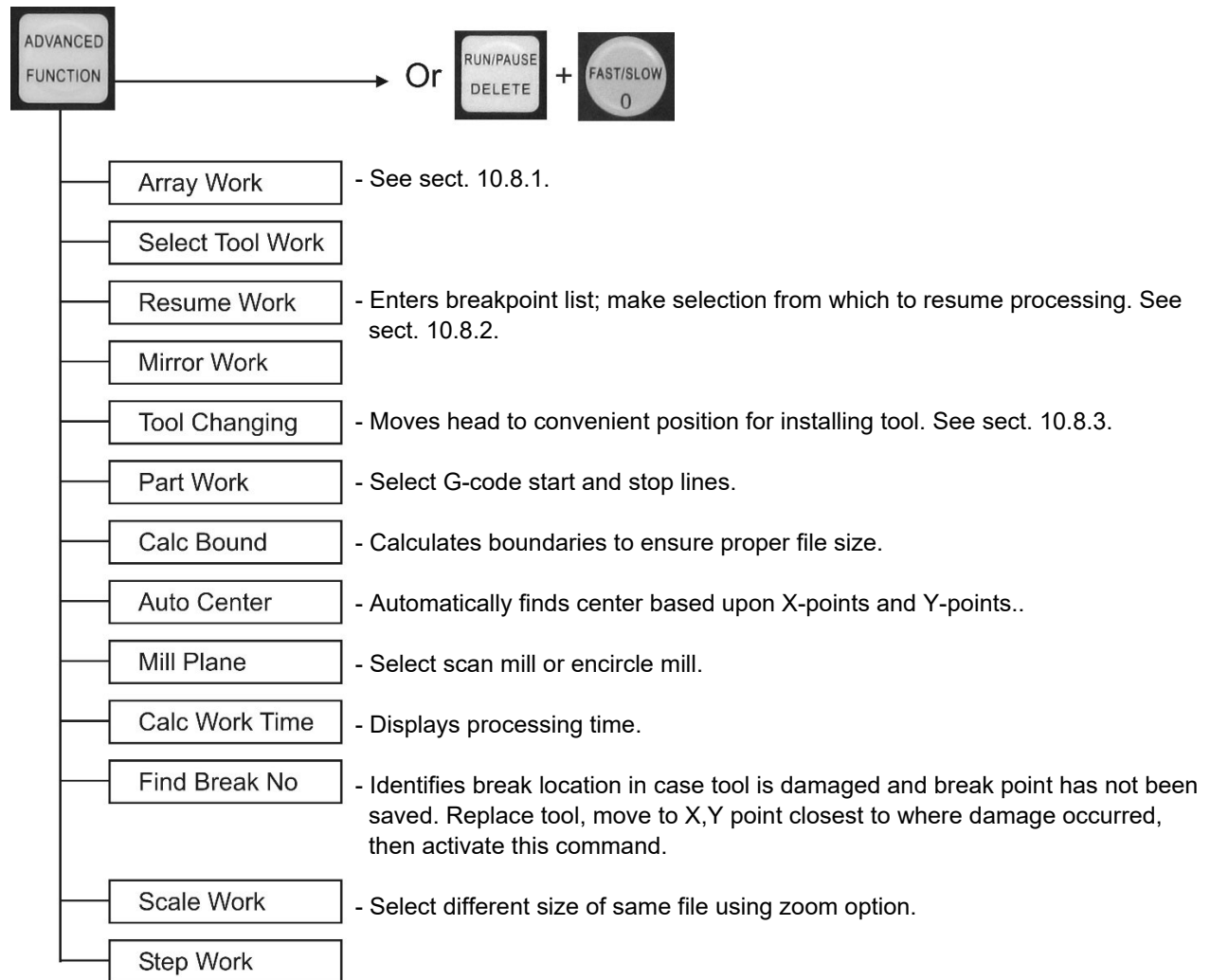

Table 5

NOTE: Not all functions may be applicable to your Powermatic unit.

## 12.0 User-maintenance

**⚠WARNING** Always disconnect power to the machine before performing maintenance. Failure to do this may result in serious personal injury.

### 12.1 General maintenance

1. Clean horizontal and vertical ball screws of dust and debris. Use a brush for crevices. Lubricate after cleaning.
2. Clean dust from table surface, using brush, compressed air or vacuum.
3. Periodically inspect cable connections and fasteners for tightness.
4. Check for tightness in motor shaft couplers.
5. Inspect slots in collet – keep them free of dust and debris.

### 12.2 Coolant (PM-2X4SP only)

Check coolant level periodically and top off as needed. Use 50/50 mix of coolant and distilled water. **(Do not use regular tap water.)**

After a time, the system should be drained and refilled with fresh coolant:

1. Remove rear cover, and unscrew fill plug (A, Figure 12-1).
2. Disconnect a hose, such as the fluid entry hose on the spindle. Drain the used coolant into a container. Follow local regulations concerning disposal of coolant.
3. Reconnect hose and fill tank nearly to the top.
4. Reinstall fill plug.

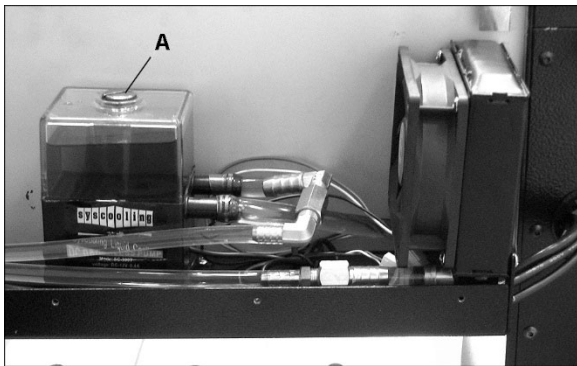

Figure 12-1

### 12.3 Lubrication

Apply oil or grease into the fittings for the *horizontal and vertical ball screws* (after cleaning them) and the *linear guides* below the table, according to the following recommendations:

Viscosity: 30~40cst (40°C), ISO rating 32~100

(Low viscosity recommended for low temperature applications; high viscosity recommended for high temperature, high load and low speed applications.)

If using grease, apply small amount (0.3 mL) periodically as needed. If using oil, apply small amount (0.1 mL) every hour of operation.

After lubrication, turn on machine and move spindle head back and forth, up and down, to distribute the grease/oil.

### 12.4 Additional servicing

Any additional servicing should be performed by an authorized service technician.

## 13.0 Additional accessories

Contact your dealer or Powermatic to order.

1797000 CNC Hold-Downs (set of 2)

1797001 CNC Dust Shoe

1797003 CNC Router Bit Set

## 14.0 Troubleshooting PM-2X2R and PM-2X4SP CNC routers

\* **WARNING:** Some corrections may require a qualified electrician.

### 14.1 Mechanical and electrical problems

Symptom	Possible Cause	Correction *
Motor will not start: fuses blow or circuit breakers trip.	Short circuit in line cord or plug.	Inspect cord or plug for damaged insulation and shorted wires.
	Short circuit in motor or loose connections.	Inspect all connections on motor for loose or shorted terminals or worn insulation.
	Incorrect fuses/breakers in power line.	Install correct fuses or circuit breakers.
Motor attempts start, but will not turn.	Jammed spindle.	Disconnect from power, try turning spindle by hand. Check reason for jamming.
	Motor faulty.	Replace spindle.
	Spindle run without coolant.	Replace motor. Maintain coolant level.
	Incorrect voltage.	Check incoming voltage.
Motor overheats (shuts off).	Dull cutting tools.	Use sharp tools.
	No coolant in reservoir, or blockage in coolant path.	Fill reservoir, check for obstacles in flow path.
Motor stalls, resulting in blown fuses or tripped circuit.	Motor overloaded.	Reduce load on motor.
	Short circuit in motor or loose connections.	Inspect connections on motor for loose or shorted terminals or worn insulation.
	Low voltage.	Correct low voltage conditions.
	Incorrect fuses or circuit breakers in power line.	Install correct fuses or circuit breakers.
Router cutting depth inconsistent.	Loose cutter.	Tighten cutter in spindle collet.
	Spoil boards not flat.	Check that spoil boards are flat and clean prior to fitting job.
	Excessive play in Z-axis ball screw.	Inspect and correct if needed.
Machine won't power on.	E-stop switch engaged.	Release red E-stop switch.
	No incoming power.	Check power plug connection. Check condition of power cable.
	Faulty start switch.	Inspect and replace.
	Internal breaker faulty.	Replace breaker.
Machine will not home.	Incorrect work space in tool path.	Verify proper work space within tool path.
	Controller has incorrect coordinate system.	Verify that controller reads 1X,1Y,1Z. If not, Press "Menu" and "1" at same time to reset. If unsure, restore information from Backup File.
	Limit switches damaged, disconnected or misadjusted.	Inspect limit switches and correct problem.
Machine vibrates.	Machine not level.	Level machine.
	Levelers not all the way down.	Lower levelers to floor.
	Fasteners not tightened.	Inspect all fasteners for tightness.
Router cutting depth not consistent.	Bit is loose in collet.	Tighten bit.
	Spoil boards not flat, or have debris.	Verify that spoil boards are flat and clean.
	Z-axis ball screw has excess play.	Adjust tightness of ball screw.

Table 6

## 14.2 Controller function problems

\* **WARNING:** Some corrections may require a qualified electrician.

Symptom	Possible Cause	Correction *
Controller display is blank or flickering.	Cable connections not tight.	Inspect and tighten connections on controller and server box.
	Insufficient power supply.	Have qualified electrician check incoming power supply.
	Fuse blown.	Inspect and replace.
	Interface damaged.	Replace damaged part.
	Controller damaged.	Replace controller.
Controller keeps restarting automatically.	Insufficient power supply.	Have qualified electrician check incoming power supply.
	Local power grid unstable.	Contact power company.
	Controller damaged.	Connect controller to computer via USB cable. If problem still occurs, replace controller.
Controller display reads "Beyond Limit".	Controller in different origin coordinate system.	Verify that controller reads 1X, 1Y, 1Z. If not, press <b>MENU + 1</b> to return to original settings.
	Machine not returned to zero point, cannot confirm actual position.	Move machine back to zero point working origin.
Cannot set work origin on controller.	Viewing wrong coordinate system.	Press <b>MENU + 1</b> to revert to first working coordinate system.
	Work origin less than actual drawing file size.	Set correct work origin based upon drawing file.
	Incorrect work origin in drawing file.	Revise drawing file and reload.
	Buttons not functioning.	Enter <b>MENU/System Setup/Buttons Check</b> to verify function. If buttons not working, replace controller.
	Work origin less than actual drawing file size.	Set correct work origin based upon drawing file.
Z-axis fall is too fast during processing.	Working speed exceeds Z-axis maximum speed.	Set to safe speed in: <b>MENU/Machine Setup/Max Speed Limit</b> .
	Loose coupling, or transmission slipping.	Tighten connecting parts.
	Connections between interface board and motor drivers are disrupted.	Check and readjust connections.
	Processing file error.	Check file; download corrected file to U-disk and retry.
	Connection between Z-axis motor and motor driver is disrupted or damaged.	Inspect and replace lines if needed.
Z-axis depth not consistent each time same file is processed and after machine homes.	Spoil board not flat.	Re-mill (flycut) spoil board.
	Workpiece is loose.	Tighten workpiece to table.
	Z-axis origin detection switch is faulty.	Replace switch.
	Interference in Z-axis homing process is creating a false origin.	Readjust lines.
Processed workpiece does not match file size.	Pulse equivalent incorrect.	Adjust pulse under: <b>MENU/Machine Setup</b> .
	Wrong cutting tool used.	Use proper tool for process.
Machine will not stop at work origin when returning.	Improper or loose connections.	Double click on <b>MENU</b> key, input signal self-test, to determine if detection signal is properly functioning.

Symptom	Possible Cause	Correction *
	Origin detection plate beyond reach of detection switch.	Inspect and adjust.
	Origin detection switch wire is loose or damaged.	Check connections.
	Origin detection switch damaged.	Replace.
	Interface board is broken.	Repair or replace.
	50-pin data cable is broken.	Replace data line.
Machine moves reverse direction when homing.	Faulty connection between origin detection switch and interface board.	Refresh line to determine if wiring is correct.
	Origin detection switch damaged.	Replace.
	Electrical interference causing false signal that limit switch has been triggered.	Recalibrate circuit.
	Interface board is broken.	Repair or replace.
	50-pin data cable is broken.	Replace data line.
Router head does not stop after contacting tool touch-off puck.	Poor connection of "Cutter" signal line to "cutter" terminal.	Restore proper connection.
	Poor connection of spindle with "GND" terminal on interface board.	Restore proper connection.
Machine will not move after controller receives commands.	One axis not moving – may be poor connection.	Connect a different axis connection to this terminal to test. If it works, motor driver is okay. Check 50-pin cable connection to interface board. If machine still won't move, determine corresponding drive and motor.
	All axes not moving.	First, check 50-pin cable connection to interface board. Then check power supply of motor drivers. Last check mechanical elements of axis system.
Machine moves to new position satisfactorily, but does not return correctly to original position.	Mechanical elements, such as ball screws, are loose or misadjusted.	Inspect and correct as needed.
Abnormal operation when processing.	Program/drawing file is faulty.	Review program and reload to system.
	Electrical interference.	Inspect connections; separate strong and weak electrical current; separate "GND" of inverter from the other components.
After controller powers on, one or more axes move only one direction.	Improper connection between interface board and motor drive.	Inspect connections.
	Interface board damaged.	Replace interface board.
	Motor driver damaged.	Replace driver.
After controller powers on, axis motor will not move.	Pulse line and direction line are switched.	Rewire pulse and direction lines.
	5V common anode end of motor driver is disconnected.	Check connection.
	Motor driver damaged.	Replace driver.
	No pulse signal output, interface board chip damaged.	Replace chip.

Symptom	Possible Cause	Correction *
Controller screen is dim. (When connected to computer via USB cable, screen is bright.)	Not connected to power supply, or power supply damaged.	Check DC24V power supply output. If okay, check cable from power supply to interface board.
	50-pin cable is damaged, or interface is broken.	Replace.
Controller screen is dim. (When connected to computer via USB cable, screen is also dim.)	Crystal processor in controller is damaged.	Have controller repaired or replaced.
	Incorrect (high) voltage power supply applied to controller.	Have controller repaired or replaced.
Screen displays "Spindle On" when spindle is off; and displays "Spindle Off" when it is on.	Improper connection on interface board.	Rewire correctly.

*Table 7*

## 15.0 Replacement Parts

Replacement parts are listed on the following pages. To order parts or reach our service department, call 1-855-336-4034 Monday through Friday, 8:00 a.m. to 5:00 p.m., CST. Or e-mail: [CNC@Powermatic.com](mailto:CNC@Powermatic.com). Having the Model Number and Serial Number of your machine available when you call will allow us to serve you quickly and accurately.

Non-proprietary parts, such as fasteners, can be found at local hardware stores, or may be ordered from Powermatic. Some parts are shown for reference only, and may not be available individually.



### 15.1.1 PM-2X2R Assembly I – Exploded View

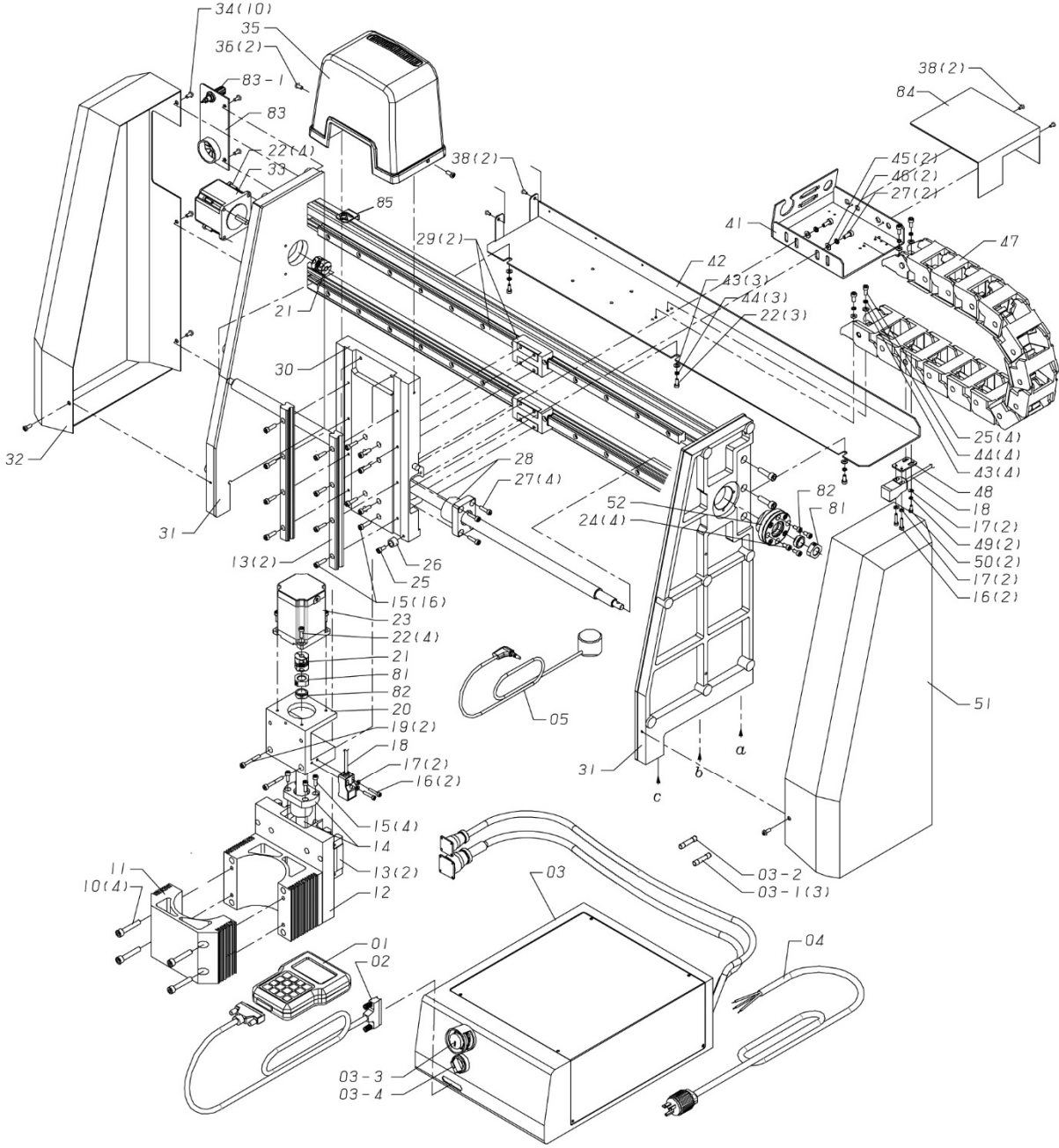

### 15.1.2 PM-2X2R Assembly II – Exploded View

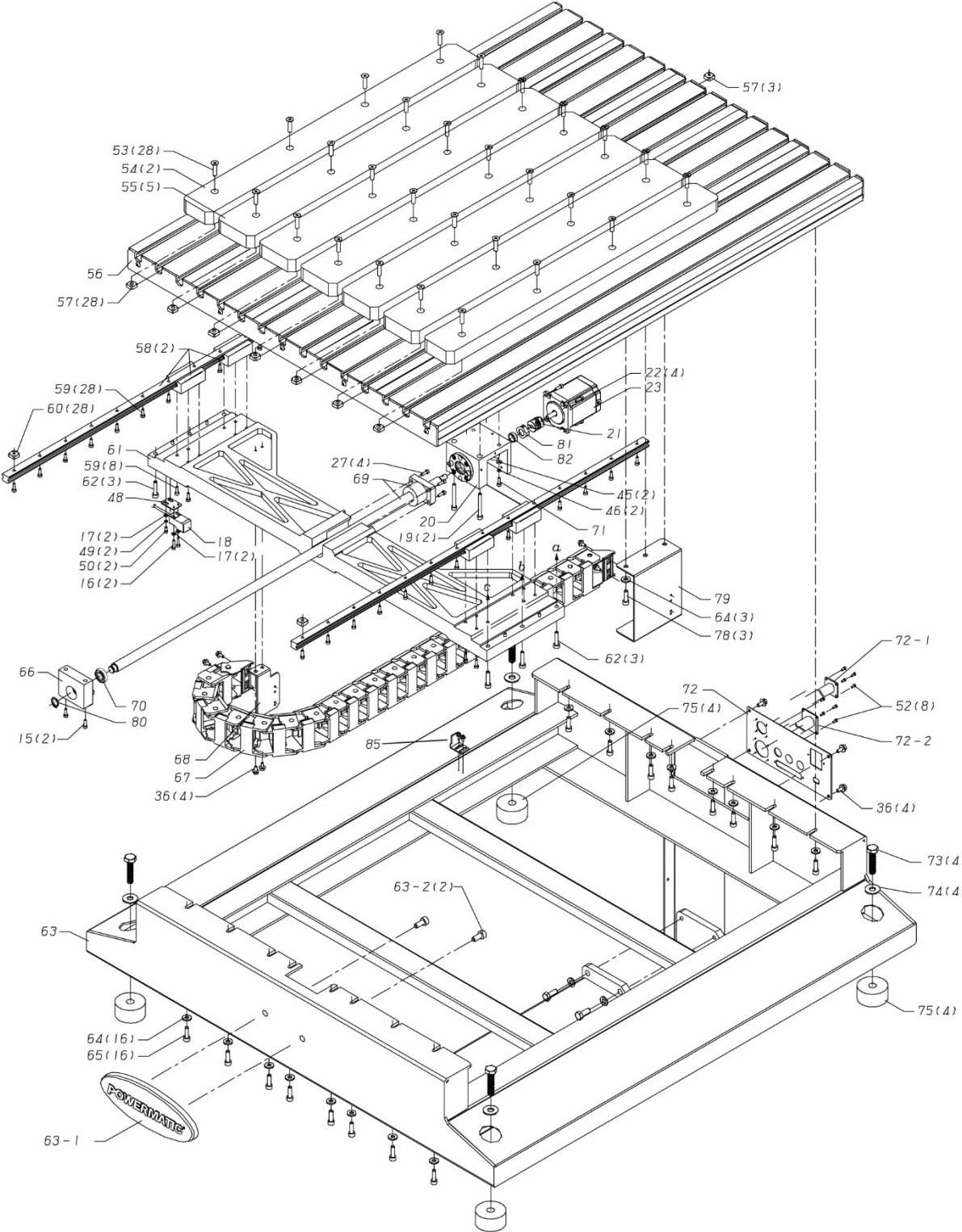

### 15.1.3 PM-2X2R Assemblies – Parts List

Index No	Part No	Description	Size	Qty
1	PM2X2R-1A	Handheld Controller	RichAuto-B11	1
2	PM2X2R-2	Controller Cable	VW-1/30V/80°C	1
3	PM2X2R-3A	Electric Cabinet Assembly (new PSU, Steppers) (models from year 2020 and forward)		1
3-1	PM2X2R-3-1	Fuse	10A	3
3-2	PM2X2R-3-2	Fuse	3A	1
3-3	PM2x2R-3-3	E-Stop Switch	E2R1RAB	1
3-4	PM2x2R-3-4	Power Switch	A204F-2E20QH-G-U	1
4	PM2X2R-4	Power Cord	14AWGx3Cx2100L, Plug type B	1
5	PM2X2R-5	Tool Touch-Off Puck		1
10	TS-1503081	Hex Socket Head Cap Screw	M6-1.0x35L	4
11	PM2X2R-11	Front Motor Holder		1
12	PM2X2R-12	Rear Motor Holder Assembly		1
13	PM2X2R-13	Z-Axis Linear Guide	15x13x220L	2
14	PM2X2R-14	Z-Axis Ball Screw	M16xP5 ,L=282.5	1
15	TS-1501051	Hex Socket Head Cap Screw	M4-0.7x16L	20
16	F005235	Hex Socket Head Cap Screw	M3-0.5x16L	6
17	TS-1550011	Flat Washer	Ø3.2x7x0.5t	10
18	PM2X2R-18	Limit Switch	DA-1805N0	3
19	TS-1502101	Hex Socket Head Cap Screw	M5-0.8x45L	4
20	PM2X2R-20	Z-Axis Motor Seat		2
21	PM2X2R-21	Coupling	SCT-20C	3
22	TS-1501041	Hex Socket Head Cap Screw	M4-0.7x12L	15
23	PM2X2R-23A	Stepper Motor	JK57HS82-5004A-02	2
24	TS-1501011	Hex Socket Head Cap Screw	M4-0.7x6L	4
25	TS-1501031	Hex Socket Head Cap Screw	M4-0.7x10L	10
26	PM2X2R-26	Rubber Pad	Ø12x8 mm	1
27	TS-1502031	Hex Socket Head Cap Screw	M5-0.8x12L	7
28	PM2X2R-28	X-Axis Ball Screw	M16xP10,L=795	1
29	PM2X2R-29	X-Axis Linear Guide	15x13x700L	2
30	PM2X2R-30	X-Axis Slide Seat		1
31	PM2X2R-31	X-Axis Moving Gantry		1
32	PM2X2R-32	Left Side Cover		1
33	PM2X2R-33A	Stepper Motor	JK57HS56-30043A-01	1
34	TS-1520041	Hex Socket Head Cap Screw	M4-0.7x6L	12
35	PM2X2R-35	Top Housing		1
36	PM2X2R-36	Truss Head Phillips Screw	M4-0.7x10L	6
38	TS-1531012	Round Head Phillips Screw	M3-0.5x6L	4
41	PM2X2R-41	X-Axis Drag Chain Seat Upper		1
42	PM2X2R-42	X-Axis Drag Chain Seat Lower		1
43	TS-1550021	Flat Washer	Ø4.2x10x0.8t	13
44	TS-2361041	Lock Washer	M4	13
45	TS-1550031	Flat Washer	Ø5.2x12x1.0t	4
46	TS-2361051	Lock Washer	M5	4
47	PM2X2R-47	X-Axis Drag Chain	A0450.21 KR52-658mm	1
48	PM2X2R-48	Limit Switch Fixed Plate		2
49	TS-2361031	Spring Washer	M3	4
50	TS-1520021	Hex Socket Head Cap Screw	M3-0.5x6L	10
51	PM2X2R-51	Right Side Cover		1
53	TS-1514041	Hex Socket Flat Head Screw	M6-1.0x25L	28
54	PM2X2R-54	MDF Spoil Strip, Side	630x65x25.4 mm	2
55	PM2X2R-55	MDF Spoil Strip, Middle	630x80x25.4 mm	5
56	PM2X2R-56	Table Assembly	989x145.3x40 mm	1
57	PM2X2R-57	Square Nut 3	M6-1.0	31
58	PM2X2R-58	Y-Axis Linear Guide	15x13x820L	2
59	TS-1501061	Hex Socket Head Cap Screw	M4-0.7x20L	44
60	PM2X2R-60	Square Nut 2	M4-0.7	28
61	PM2X2R-61	Y-Axis Slide Seat		1
62	TS-1503061	Hex Socket Head Cap Screw	M6-1.0x25L	6

Index No	Part No	Description	Size	Qty
63	PM2X2R-63	Base		1
63-1	PM2x2R-63-1	Powermatic Logo	242x89x15 mm	1
63-2	TS-0207041	Socket HD Cap Screw	1/4"-20UNCx3/4	2
64	TS-1550041	Flat Washer	M6	35
65	TS-1503051	Hex Socket Head Cap Screw	M6-1.0x20L	16
66	PM2X2R-66	Y-Axis Bearing Seat		1
67	PM2X2R-67	Y-Axis Drag Chain	L=987	
68	PM2X2R-68	Y-Axis Drag Chain Fixed Plate A		1
69	PM2X2R-69	Y-Axis Ball Screw	M16xP10,L=810	1
70	BB-6901ZZ	Bearing	#6901ZZ	1
71	TS-1502051	Hex Socket Head Cap Screw	M5-0.8x20L	2
72	PM2X2R-72	Base Rear Plate		1
72-1	PM2x2R-72-1	Cable A For 110v Power Cable		1
72-2	PM2x2R-72-2	Cable B For Step Motor/Sensor		1
73	F009506	Hex Cap Screw	M10-1.5x45L	4
74	TS-1550071	Washer	Ø10.2x25x2t	4
75	PM2X2R-75	Table Foot		4
78	TS-1503041	Hex Socket Head Cap Screw	M6-1.0x16L	3
79	PM2X2R-79	Y-Axis Drag Chain Fixed Plate B		1
80	PM2x2R-80	Retaining Ring	Φ12	1
81	PM2x2R-81	Locking Nut		3
82	PM2x2R-82	Spacer		3
83	PM2x2R-83	Cable Entry Plate		1
83-1	PM2x2R-83-1	Tool Touch-off Receptacle	N1535	1
84	PM2x2R-84	X Axis Drag Chain Seat Cover		1
85	PM2X2R-85	Adjustable Stop		2
	PM2X2R-HP1	Hardware Package 1 (not shown) (see sect.7.1 to identify)		
	PM2X2R-HP2	Hardware Package 2 (not shown) (see sect.7.1 to identify)		
	PM2X2R-HP3	Hardware Package 3 (not shown) (see sect.7.1 to identify)		

**15.2.1 PM-2X2S Stand Assembly – Exploded View**

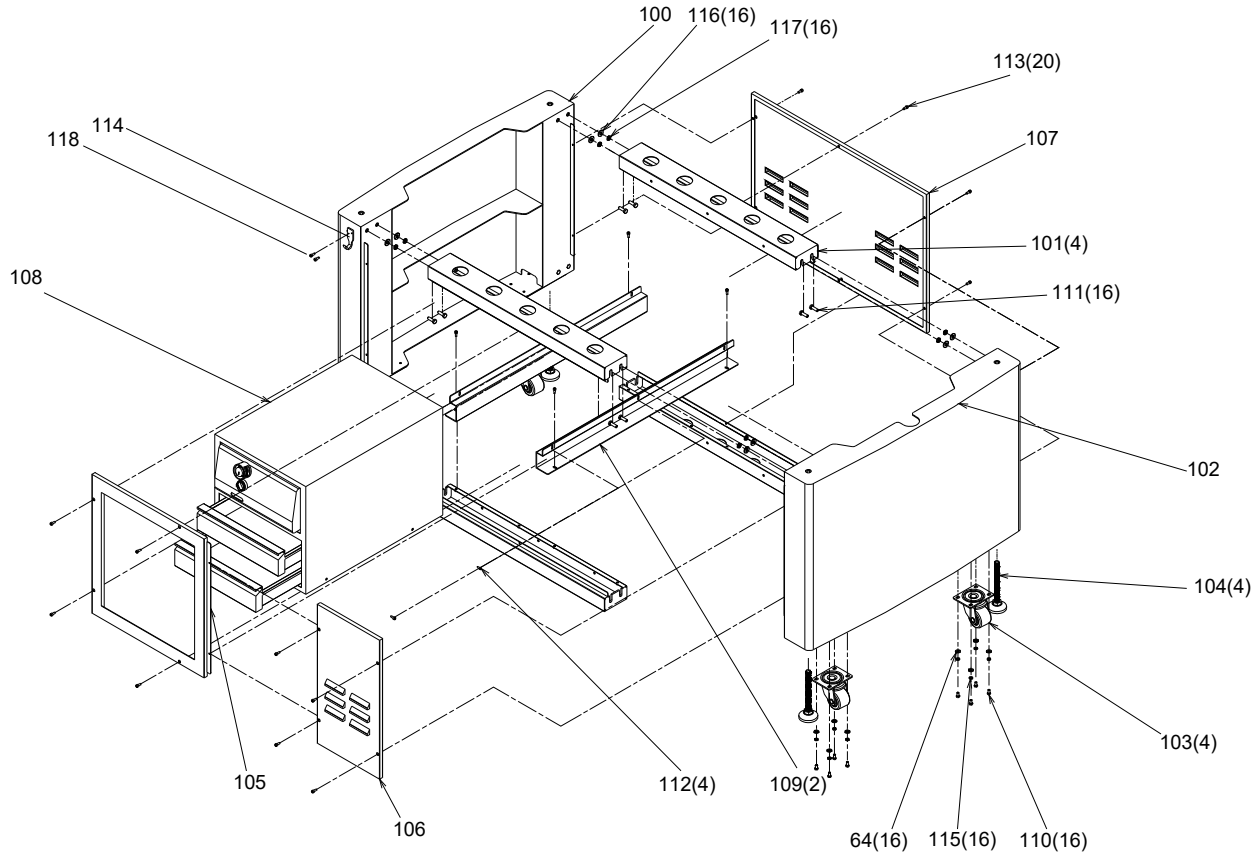

**15.2.2 PM-2X2S Stand Assembly – Parts List**

Index No	Part No	Description	Size	Qty
64	TS-1550041	Flat Washer	M6	16
100	PM2x2S-100	Front Panel		1
101	PM2x2S-101	Cross Brace		4
102	PM2x2S-102	Rear Panel		1
103	PM2x2S-103	Swivel Caster		4
104	PM2x2S-104	Leveling Foot		4
105	PM2x2S-105	Open Side Panel		1
106	PM2x2S-106	Right Side Panel		1
107	PM2x2S-107	Left Side Panel		1
108	PM2x2S-108	Tool Cabinet Assembly		1
109	PM2x2S-109	Tool Cabinet Brace		2
110	TS-1482021	Hex Cap Screw	M6x12	16
111	TS-1490041	Hex Cap Screw	M8x25	16
112	TS-1501031	Socket Head Cap Screw	M4x10	4
113	TS-1481031	Socket Head Cap Screw	M5x12	20
114	PM2x2S-114	Controller Hook		1
115	TS-2361061	Lock Washer	M6	16
116	TS-1550061	Flat Washer	M8	16
117	TS-2361081	Lock Washer	M8	16
118	TS-2171012	Phillips Pan Hd Machine Screw	M4x6	2
	PM2X2S-HP	Stand Hardware Package (includes # 64,110,111,114-118)		



### 15.3.2 PM-2X4SP Assembly II – Exploded View

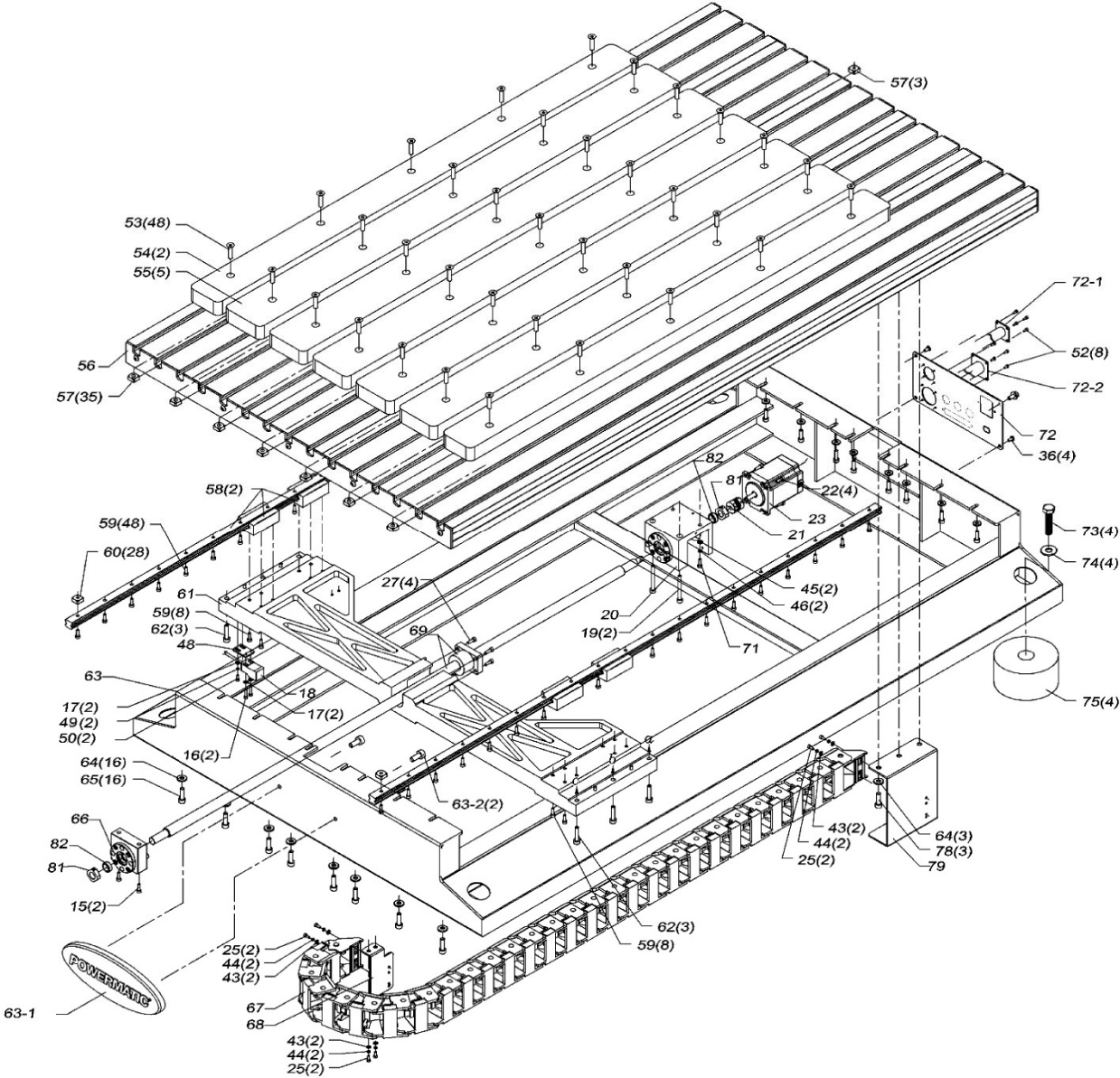

### 15.3.3 PM-2X4SP Assemblies – Parts List

Index No	Part No	Description	Size	Qty
1	PM2X2R-1A	Handheld Controller	RichAuto-B11	1
2	PM2X2R-2	Controller Cable	VW-1/30V/80°C	1
3	PM2X4SP-3A	Electric Cabinet Assembly (new VFD,PSU,Steppers) (models from year 2020 and forward)		1
3-1	PM2X2R-3-1	Fuse	10A	3
3-2	PM2X2R-3-2	Fuse	3A	1
3-3	PM2x2R-3-3	E-Stop Switch	E2R1RAB	1
3-4	PM2x2R-3-4	Power Switch	A204F-2E20QHJ-U	1
4	PM2X2R-4	Power Cord	14AWGx3Cx2100L, Plug NEMA 6-20P	1
5	PM2X2R-5	Tool Touch-Off Puck		1
6	PM2X4SP-6A	Router Spindle	2.2kW/7.5A/24000rpm	1
7	PM2X4SP-7A	Motor Cable	FT1-17AWGx4C	1
8	PM2X4SP-8	Coolant Tube In	Ø10 x 1350L mm	1
9	PM2X4SP-9	Coolant Tube Out	Ø10 x 1350L mm	1
10	TS-1503081	Hex Socket Head Cap Screw	M6-1.0x35L	4
11	PM2X4SP-11	Front Spindle Holder		1
12	PM2X4SP-12	Rear Spindle Holder Assembly		1
13	PM2X2R-13	Z-Axis Linear Guide	15x13x220L	2
14	PM2X2R-14	Z-Axis Ball Screw	M16xPitch5 ,L=282.5	1
15	TS-1501051	Hex Socket Head Cap Screw	M4-0.7x16L	20
16	F005235	Hex Socket Head Cap Screw	M3-0.5x16L	6
17	TS-1550011	Flat Washer	Ø3.2x7x0.5t	10
18	PM2X2R-18	Limit Switch	DA-1805N0	3
19	TS-1502101	Hex Socket Head Cap Screw	M5-0.8x45L	4
20	PM2X2R-20	Z-Axis Motor Seat		2
21	PM2X2R-21	Coupling	SCT-20C	3
22	TS-1501041	Hex Socket Head Cap Screw	M4-0.7x12L	15
23	PM2X2R-23A	Stepper Motor	JK57HS82-5004A-02	2
24	TS-1501011	Hex Socket Head Cap Screw	M4-0.7x6L	4
25	TS-1501031	Hex Socket Head Cap Screw	M4-0.7x10L	9
26	PM2X2R-26	Rubber Pad	Ø12x8 mm	1
27	TS-1502031	Hex Socket Head Cap Screw	M5-0.8x12L	10
28	PM2X2R-28	X-Axis Ball Screw	M16xPitch10,L=795	1
29	PM2X2R-29	X-Axis Linear Guide	15x13x700L	2
30	PM2X2R-30	X-Axis Slide Seat		1
31	PM2X2R-31	X-Axis Moving Gantry		1
32	PM2X2R-32	Left Side Cover		1
33	PM2X2R-33A	Stepper Motor	JK57HS56-30043A-01	1
34	TS-1501011	Hex Socket Head Cap Screw	M4-0.7x6L	12
35	PM2X2R-35	Top Housing		1
36	PM2X2R-36	Truss Head Phillips Screw	M4-0.7x10L	6
37	PM2X4SP-37	Flex Tube	Ø40x500L	1
38	TS-1531012	Round Head Phillips Screw	M3-0.5x6L	5
39	PM2X4SP-39A	Liquid Coolant System	Dongyuan-SC-P60D	1
40	PM2X4SP-40	Coolant System Cover		1
41	PM2X2R-41	X-Axis Drag Chain Seat Upper		1
42	PM2X2R-42	X-Axis Drag Chain Seat Lower		1
43	TS-1550021	Flat Washer	Ø4.2x10x0.8t	13
44	TS-2361041	Lock Washer	M4	13
45	TS-1550031	Flat Washer	Ø5.2x12x1.0t	4
46	TS-2361051	Lock Washer	M5	4
47	PM2X2R-47	X-Axis Drag Chain	A0450.21 KR52-658mm	1
48	PM2X2R-48	Limit Switch Fixed Plate		2
49	TS-2361031	Spring Washer	M3	4
50	TS-1520021	Hex Socket Head Cap Screw	M3-0.5x6L	10
51	PM2X2R-51	Right Side Cover		1
52	PM2x2R-52	X Axis Bearing Seat Assembly		1
53	TS-1514041	Hex Socket Flat Head Screw	M6-1.0x25L	35
54	PM2X4SP-54	MDF Spoil Strip, Side	1235x65x25.4 mm	2



Index No	Part No	Description	Size	Qty
55	PM2X4SP-55	MDF Spoil Strip, Middle	1235x80x25.4 mm	5
56	PM2X4SP-56	Table Assembly	1594x145.3x40 mm	1
57	PM2X2R-57	Square Nut 3	M6-1.0	38
58	PM2X4SP-58	Y-Axis Linear Guide	15x13x1420L	2
59	TS-1501061	Hex Socket Head Cap Screw	M4-0.7x20L	64
60	PM2X2R-60	Square Nut 2	aM4-0.7	48
61	PM2X2R-61	Y-Axis Slide Seat		1
62	TS-1503061	Hex Socket Head Cap Screw	M6-1.0x25L	6
63	PM2X4SP-63	Base		1
63-1	PM2x2R-63-1	Powermatic Logo	242x89x15	1
63-2	TS-0207041	Socket HD Cap Screw	1/4"-20UNCx 3/4L	2
64	TS-1550041	Flat Washer	M6	35
65	TS-1503051	Hex Socket Head Cap Screw	M6-1.0x20L	16
66	PM2X4SP-66	Y-Axis Bearing Seat		1
67	PM2X4SP-67	Y-Axis Drag Chain	L=1551	1
68	PM2X2R-68	Y-Axis Drag Chain Fixed Plate A		1
69	PM2X4SP-69	Y-Axis Ball Screw		1
71	TS-1502051	Hex Socket Head Cap Screw	M5-0.8x20L	2
72	PM2X2R-72	Base Rear Plate		1
72-1	PM2x2R-72-1	Cable A For 110v Power Cable		1
72-2	PM2x2R-72-2	Cable B For Step Motor/Sensor		1
73	F009506	Hex Cap Screw	M10-1.5x45L	4
74	PM2X2R-74	Washer	Ø10.2x25x2t	4
75	PM2X2R-75	Table Foot		4
78	TS-1503041	Hex Socket Head Cap Screw	M6-1.0x16L	3
79	PM2X2R-79	Y-Axis Drag Chain Fixed Plate B		1
81	PM2x2R-81	Locking Nut		4
82	PM2x2R-82	Spacer		4
83	PM2x2R-83	Cable Entry Plate		1
83-1	PM2x2R-83-1	Tool Touch-off Receptacle	N1535	1
84	PM2x2R-84	X Axis Drag Chain Seat Cover		1
85	JHL610-901	Hex Wrench	2x60L mm	1
86	PM2X4SP-86	Open End Wrench	30x21 mm	2
87	PM2X4SP-87	Collet Nut	ER20	1
88	PM2x2R-85	Adjustable Stop		2
	PM2X2R-HP1	Hardware Package 1 (not shown) (see sect.7.4 to identify)		
	PM2X2R-HP2	Hardware Package 2 (not shown) (see sect.7.4 to identify)		
	PM2X2R-HP3	Hardware Package 3 (not shown) (see sect.7.4 to identify)		

### 15.4.1 PM-2X4S Stand Assembly – Exploded View

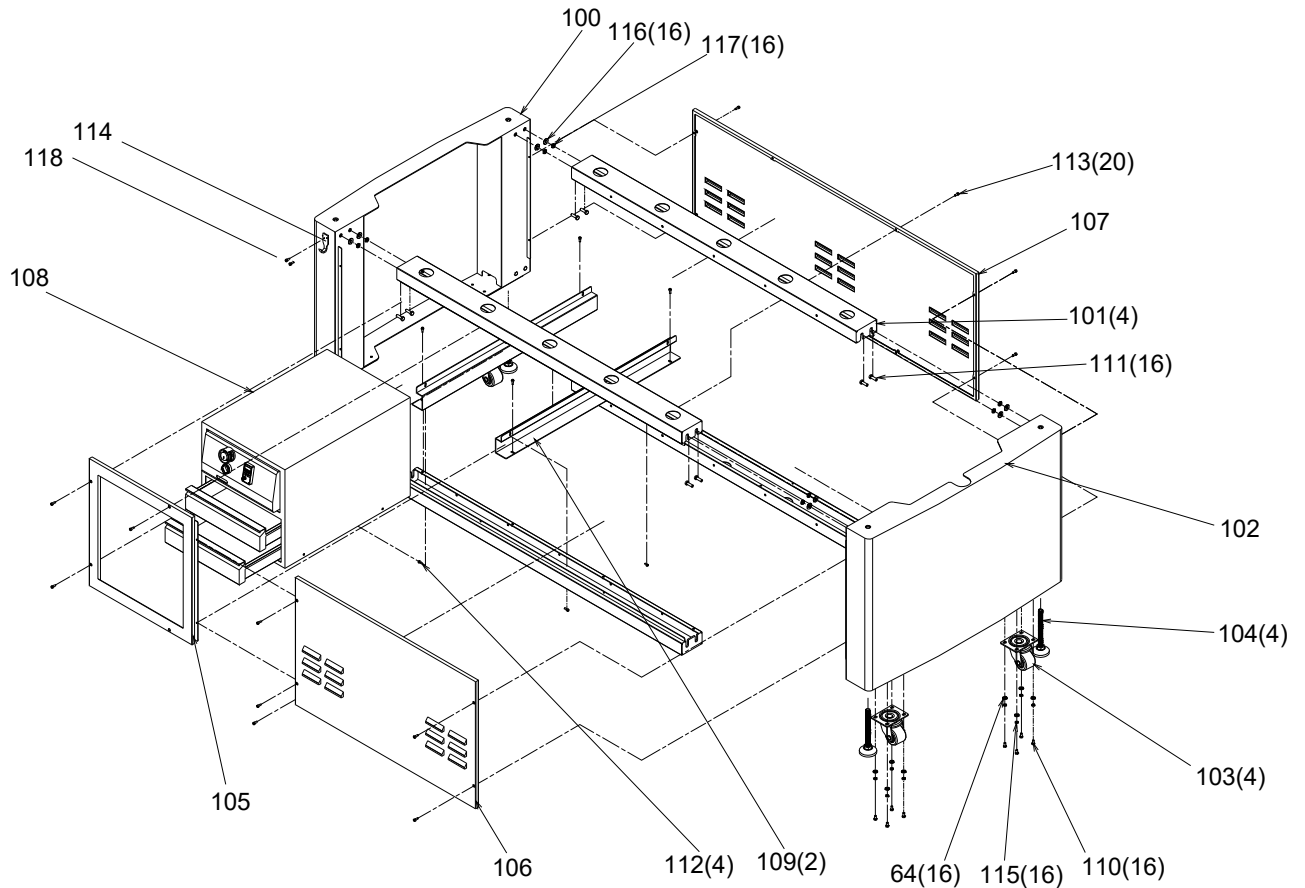

### 15.4.2 PM-2X4S Stand Assembly – Parts List

Index No	Part No	Description	Size	Qty
64	TS-1550041	Flat Washer	M6	16
100	PM2x2S-100	Front Panel		1
101	PM2x4S-101	Cross Brace		4
102	PM2x2S-102	Rear Panel		1
103	PM2x2S-103	Swivel Caster		4
104	PM2x2S-104	Leveling Foot		4
105	PM2x2S-105	Open Side Frame		1
106	PM2x4S-106	Right Side Panel		1
107	PM2x4S-107	Left Side Panel		1
108	PM2x2S-108	Tool Cabinet Assembly		1
109	PM2x2S-109	Tool Cabinet Brace		2
110	TS-1482021	Hex Cap Screw	M6x12	16
111	TS-1490041	Hex Cap Screw	M8x25	16
112	TS-1501031	Socket HD Cap Screw	M4x10	4
113	TS-1481031	Socket HD Cap Screw	M5x12	20
114	PM2x2S-114	Controller Hook		1
115	TS-2361061	Lock Washer	M6	16
116	TS-1550061	Flat Washer	M8	16
117	TS-2361081	Lock Washer	M8	16
118	TS-2171012	Phillips Pan Hd Machine Screw	M4x6	2
	PM2X2S-HP	Stand Hardware Package (includes # 64,110,111,114-118)		

# 16.0 Electrical Connections for CNC Router

## 16.1 Main circuit diagram – model PM-2X2R only

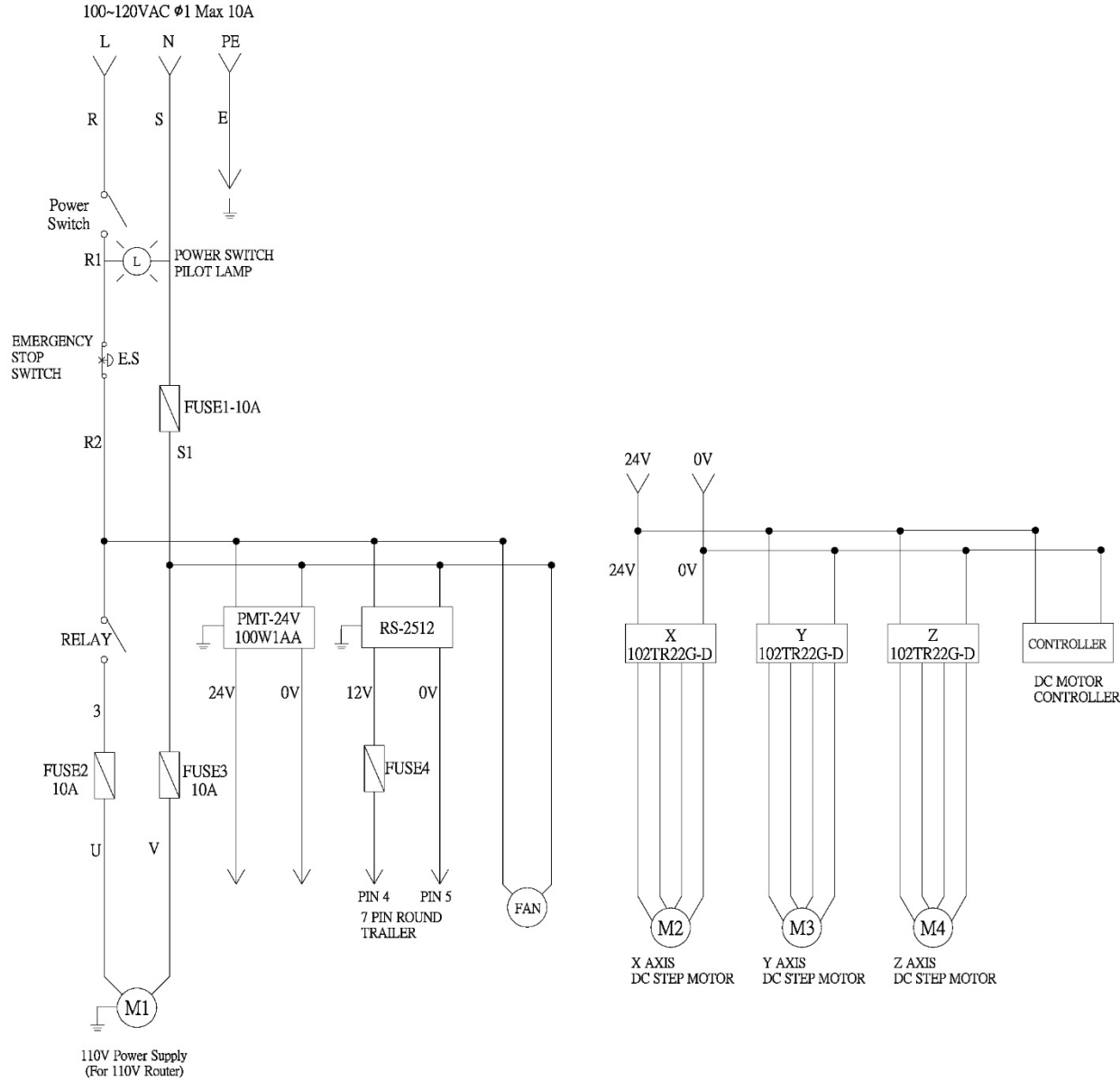

### 16.2 Main circuit diagram – model PM-2X4SP only

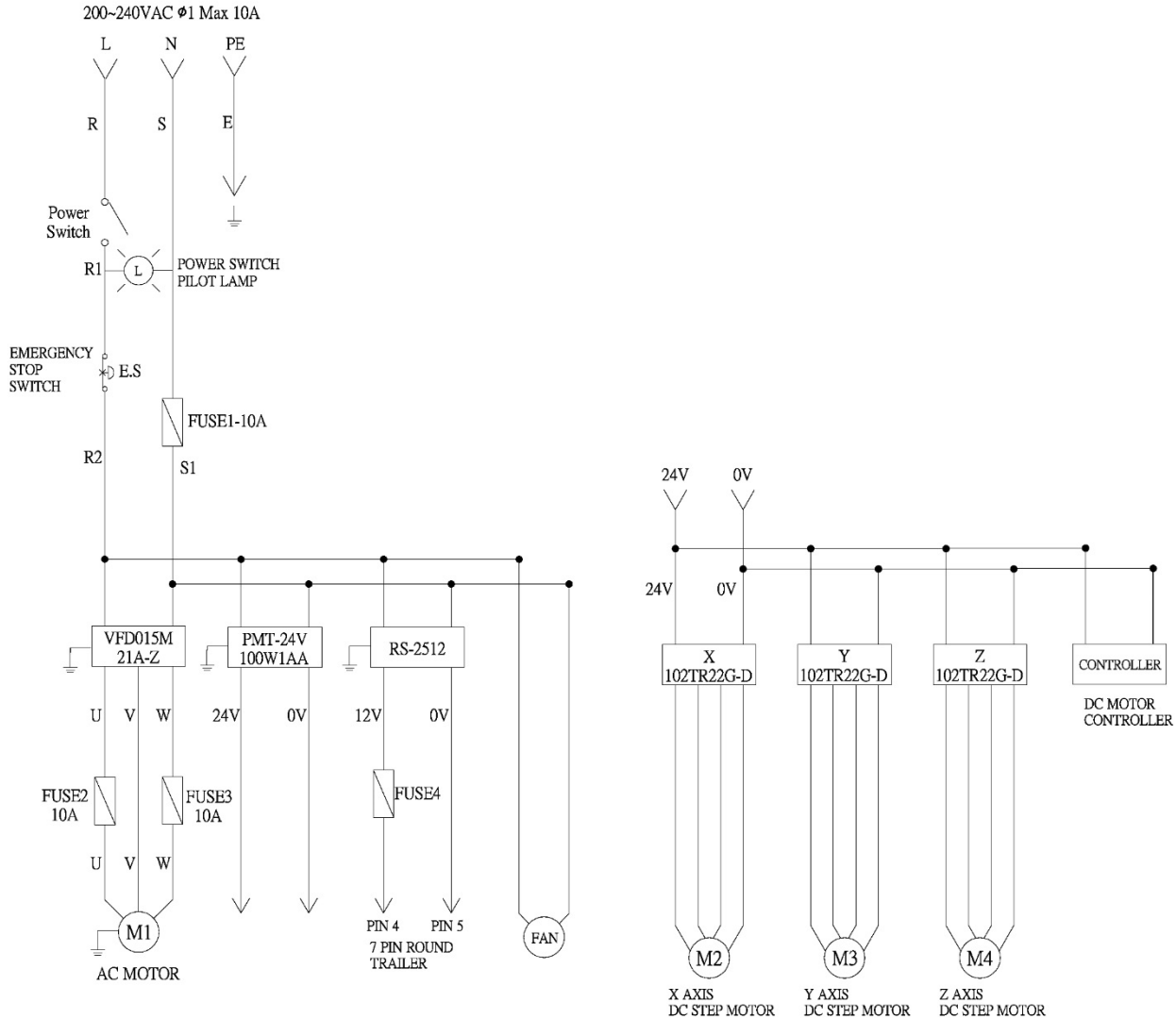

16.3 7-Pin Cable Connector

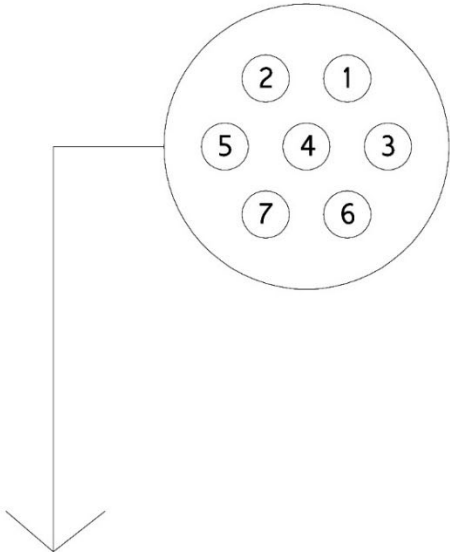

Wire Color	Number	Location
Red	U	1
White	V	2
Black	W	3
Green	E	4
Yellow	12V	5
Blue	1	6
Gray	P	7

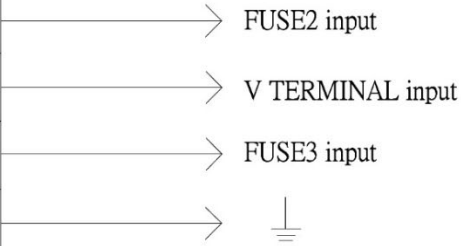

## 16.4 26-Pin Cable Connector

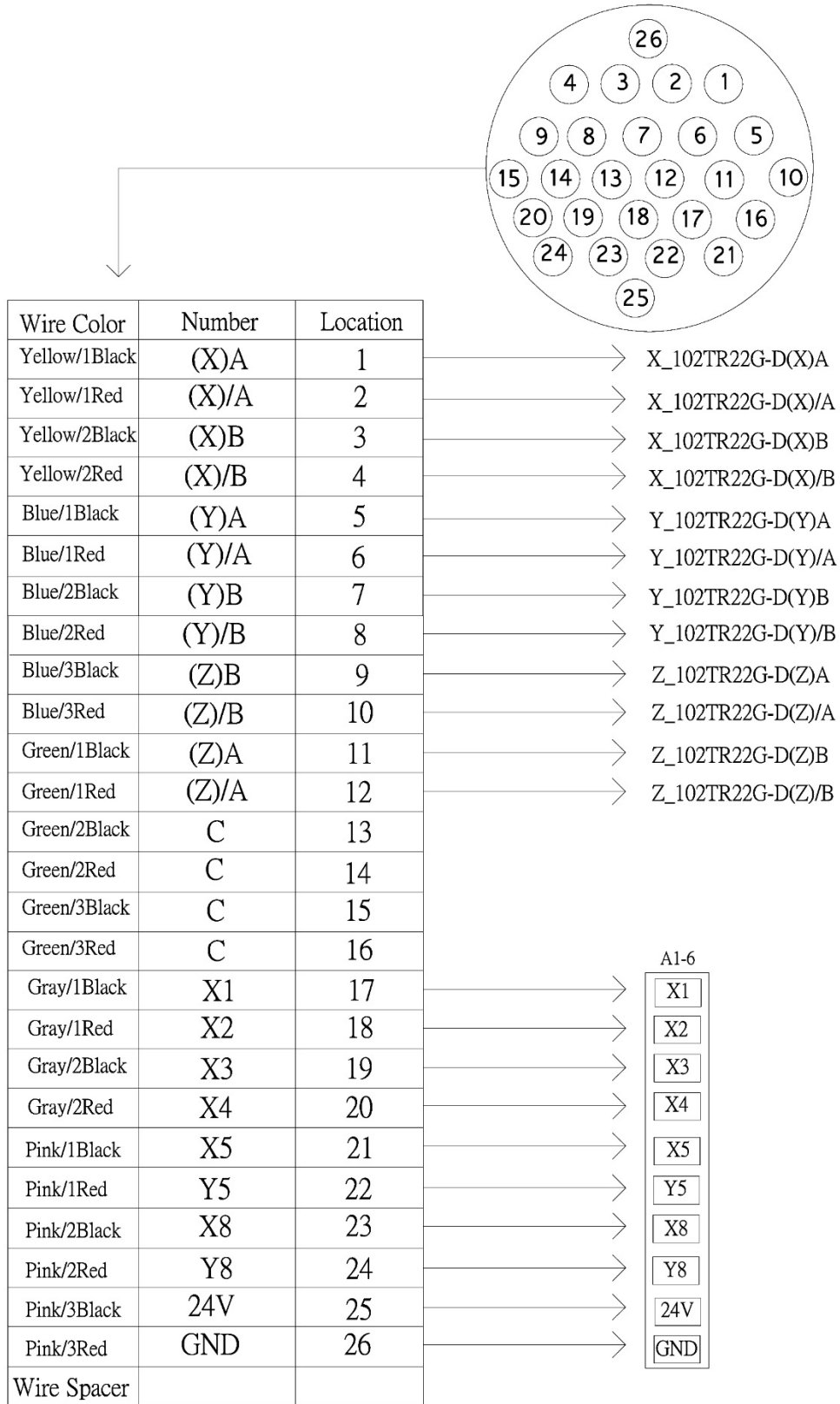

# 16.5 Handheld controller connections

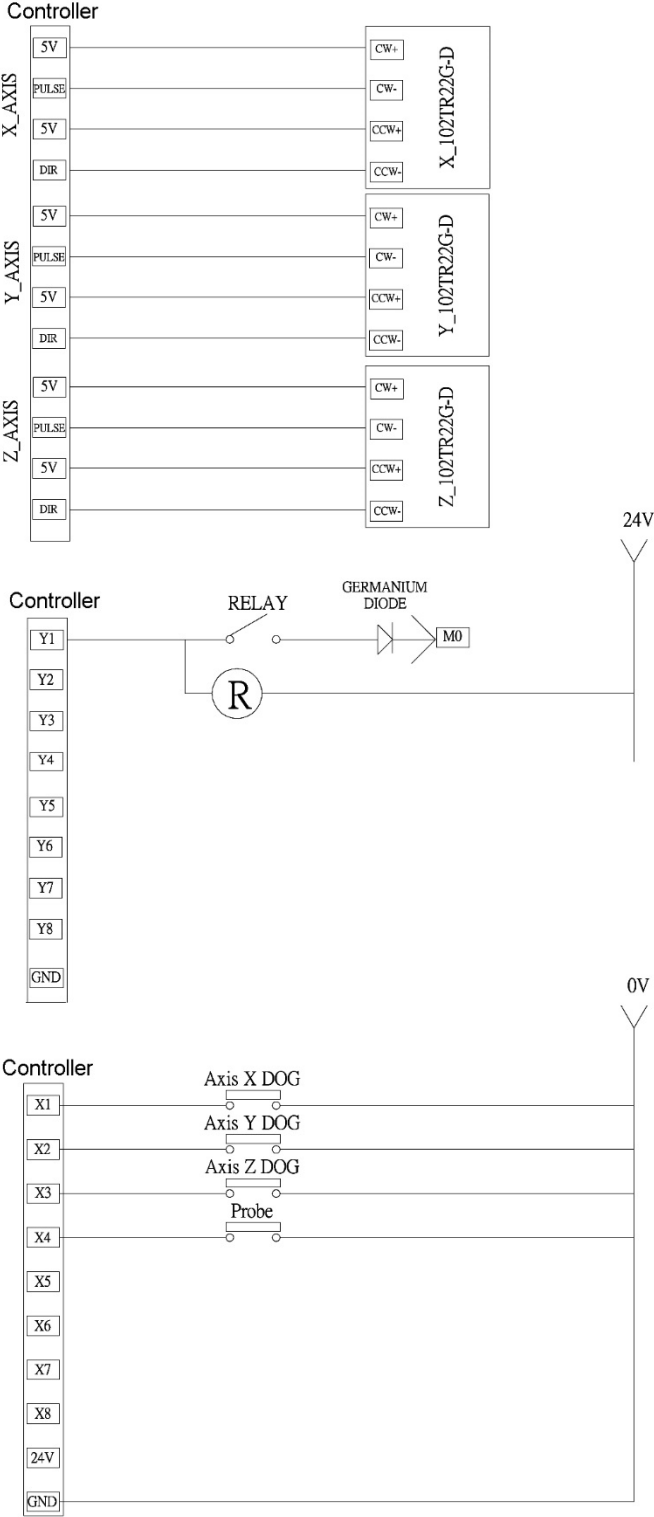

## 16.6 Patch board connections

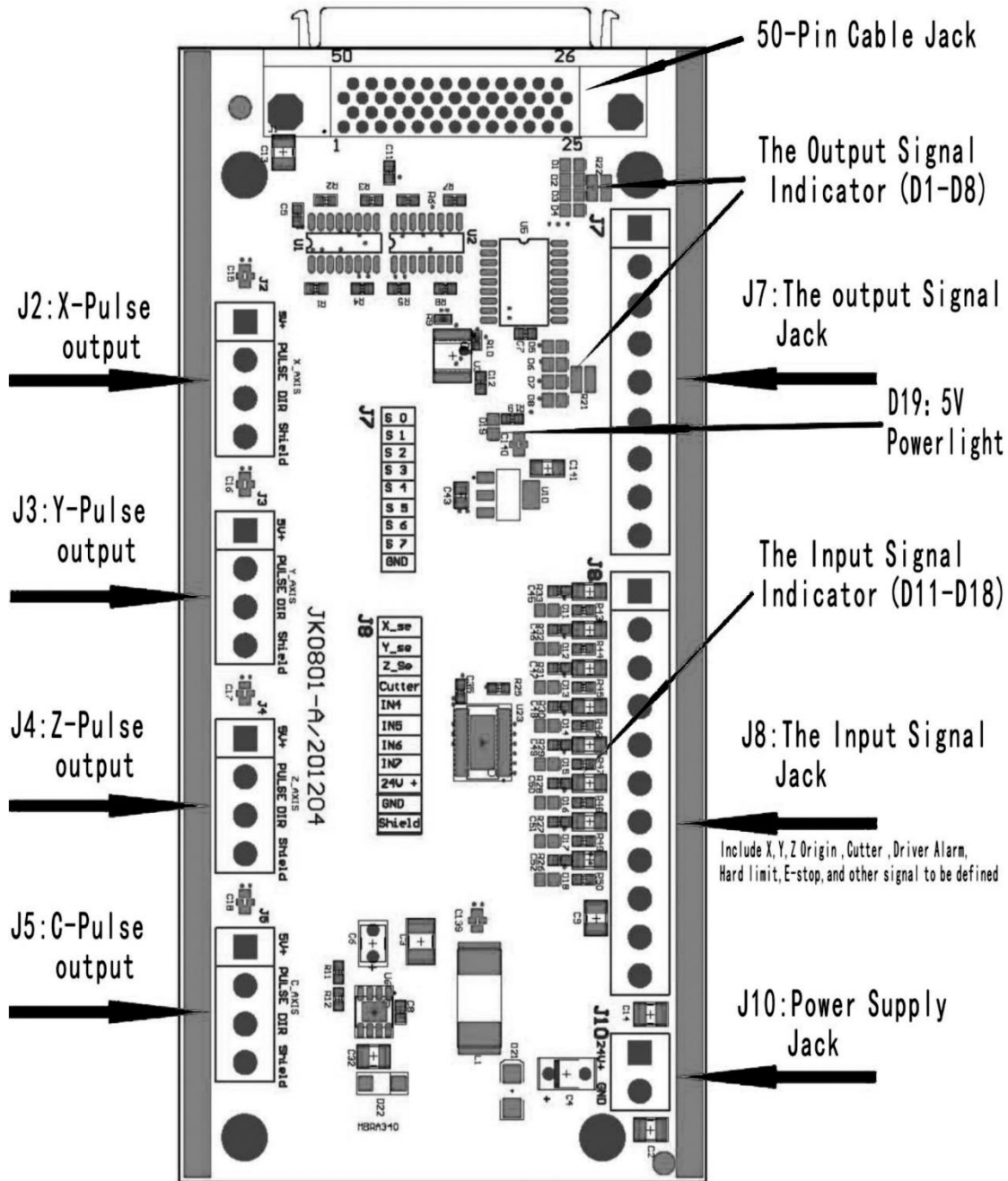

Used with permission of Ruizhitianhong S&T Co. Ltd



## 16.7 Patch board I/O descriptions

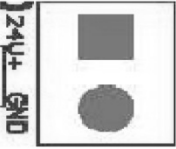
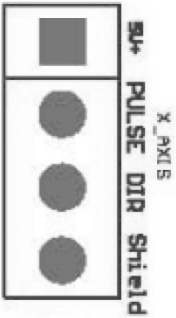
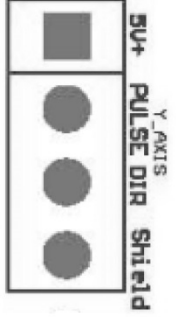

Port label	Port definition	Pin Definition	Pin functions and parameters	Notes
<b>J10</b> 	System Main power	System main power supply side	System main power supply terminal , interface board give DC 5V for system . When F3 shorted can provide voltage to XYZ	Power area : DC10V~DC24V/3A~40V
<b>J 2</b> 	X-axis pulse output port	Were positive signal output port	X-axis drive common anode power supply terminal 5V output	Do not impose voltage on this pin
		Pulse signal output port	X-axis drive pulse signal output port, the output voltage $\geq 3V$ drive current $\leq 8mA$	
		direction signal output port	X-axis direction of the drive signal output port output voltage $\geq 3V$ drive current $\leq 8mA$	
		Shield connection port	X-axis drive signal output voltage line terminal shield	Do not use this port for the grounding port
<b>J 3</b> 	Y-axis pulse output port	Were positive signal output port	Y-axis drive common anode power supply terminal 5V output	Do not impose voltage on this pin
		Pulse signal output port	Y-axis drive pulse signal output port, the output voltage $\geq 3V$ drive current $\leq 8mA$	
		direction signal output port	Y-axis direction of the drive signal output port output voltage $\geq 3V$ drive current $\leq 8mA$	
		Shield connection port	Y-axis drive signal output voltage line terminal shield	Do not use this port for the grounding port

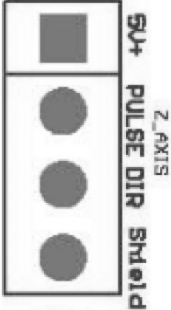
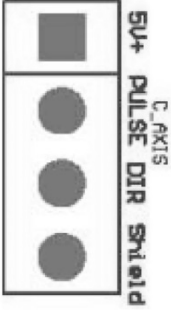
Used with permission of Ruizhitianhong S&T Co. Ltd

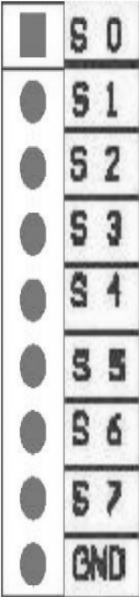
Port label	Port definition	Pin Definition	Pin functions and parameters	Notes
<b>J 4</b> 	Z-axis pulse output port	Were positive signal output port	Z-axis drive common anode power supply terminal 5V output	Do not impose voltage on this pin
		Pulse signal output port	Z-axis drive pulse signal output port, the output voltage $\cong 3V$ drive current $\cong 8mA$	
		direction signal output port	Z-axis direction of the drive signal output port output voltage $\cong 3V$ drive current $\cong 8mA$	
		Shield connection port	Z-axis drive signal output voltage line terminal shield	Do not use this port for the grounding port
<b>J 5</b> 	C-axis pulse output port	Were positive signal output port	C-axis drive common anode power supply terminal 5V output	Do not impose voltage on this pin
		Pulse signal output port	C-axis drive pulse signal output port, the output voltage $\cong 3V$ drive current $\cong 8mA$	
		direction signal output port	C-axis direction of the drive signal output port output voltage $\cong 3V$ drive current $\cong 8mA$	
		Shield connection port	C-axis drive signal output voltage line terminal shield	Do not use this port for the grounding port

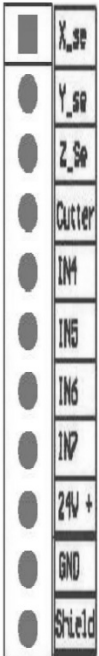
Port label	Port definition	Pin Definition	Pin functions and parameters	Notes
<b>J 7</b> 	<b>Output Control terminal</b>	Y1(S0): Spindle ON/OFF	Connect to FWD of inverter	Output Low level signal
		Y2(S1): speed 1	Connect to inverter to control speed	Output Low level signal
		Y3(S2): speed 2	Connect to inverter to control speed	Output Low level signal
		Y4(S3): speed 3	Connect to inverter to control speed	Output Low level signal
		Y5(S4): Alarm LED	Light when there is something wrong with system	Output Low level signal
		Y6(S5): Work LED	Light when system works	Output Low level signal
		Y7(S6): definable	user-defined signal	Output Low level signal
		Y8(S7): definable	user-defined signal	Output Low level signal
		GND:output GND		GND connect to this terminal in control inverter speed mode

Port label	Port definition	Pin Definition	Pin functions and parameters	Notes
<b>J 8</b> 	input Control terminal	<b>X1:X_se: X origin sensor Signal Input</b>	<b>X origin sensor signal input terminal</b>	<b>Input low level signals</b>
		<b>X2:Y_se: Y origin sensor Signal Input</b>	<b>Y origin sensor signal input terminal</b>	<b>Input low level signals</b>
		<b>X3:Z_se: Z origin sensor Signal Input</b>	<b>Z origin sensor signal input terminal</b>	<b>Input low level signals</b>
		<b>X4:CutterTool-setting sensor signal input</b>	<b>Tool-setting sensor signal input terminal</b>	<b>Input low level signals</b>
		<b>X5: Driver alarm signal input</b>	<b>Driver alarm signal input terminal</b>	<b>Input low level signals</b>
		<b>X6:Hard limit signal input</b>	<b>Hard Limit signal input terminal</b>	<b>Input low level signals</b>
		<b>X7: E-stop signal input</b>	<b>E-stop signal input terminal</b>	<b>Input low level signals</b>
		<b>X8: Definable signal</b>	<b>Definable signal input terminal</b>	<b>Input low level signals</b>
		<b>24V+: Sensor power input</b>	<b>X、 Y、 Z sensor isolate circuit power supply positive input terminal</b>	<b>Sensor isolate circuit supply voltage range DC10V~DC24V</b>
		<b>GND: GDN input</b>	<b>X、 Y、 Z sensor isolate circuit power supply negative input terminal</b>	
		<b>Shield: Shield input</b>	<b>Sensor signal cable shield input terminal</b>	<b>Do not use this port as a negative use of the sensor isolation circuit power</b>

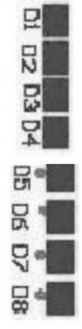
Port label	Port definition	Pin Definition	Pin functions and parameters	Notes
	D19	Power LED	Interface board 5V indicator indicate the interface and internal power supply status moderators	Lights after power
	D11	Status indicator	X origin status indicator	Light after power. Input low level signal, the lights will be put out. Release the signal, the lights will be bright again
	D12	Status indicator	Y origin status indicator	
	D13	Status indicator	Z origin status indicator	
	D14	Status indicator	Tool-setting Status indicator	
	D15	Status indicator	Driver alarm status indicator	
	D16	Status indicator	Hard Limit status indicator	
	D17	Status indicator	E-stop status indicator	
	D18	Status indicator	Definable signal status indicator	
	D1	Status indicator	output terminal Y1 status indicator	Output low level signal when the system works
	D2	Status indicator	output terminal Y2 status indicator	
	D3	Status indicator	output terminal Y3 status indicator	
	D4	Status indicator	output terminal Y4 status indicator	
	D5	Status indicator	output terminal Y5 status indicator	
	D6	Status indicator	output terminal Y6 status indicator	
	D7	Status indicator	output terminal Y7 status indicator	
	D8	Status indicator	output terminal Y8 status indicator	

Used with permission of Ruizhitianhong S&T Co. Ltd

## 17.0 Warranty and service

Powermatic warrants every product it sells against manufacturers' defects. If one of our tools needs service or repair, please contact CNC Technical Service by calling 1-855-336-4034, 8AM to 5PM CST, Monday through Friday.

### Warranty Period

The general warranty lasts for the time period specified in the literature included with your product or on the official Powermatic branded website.

- Powermatic products carry a limited warranty which varies in duration based upon the product. (See chart below)
- Accessories carry a limited warranty of one year from the date of receipt.
- Consumable items are defined as expendable parts or accessories expected to become inoperable within a reasonable amount of use and are covered by a 90 day limited warranty against manufacturer's defects.

### Who is Covered

This warranty covers only the initial purchaser of the product from the date of delivery.

### What is Covered

This warranty covers any defects in workmanship or materials subject to the limitations stated below. This warranty does not cover failures due directly or indirectly to misuse, abuse, negligence or accidents, normal wear-and-tear, improper repair, alterations or lack of maintenance. Powermatic woodworking machinery is designed to be used with Wood. Use of these machines in the processing of metal, plastics, or other materials outside recommended guidelines may void the warranty. The exceptions are acrylics and other natural items that are made specifically for wood turning.

### Warranty Limitations

Woodworking products with a Five Year Warranty that are used for commercial or industrial purposes default to a Two Year Warranty. Please contact Technical Service at 1-855-336-4034 for further clarification.

### How to Get Technical Support

Please contact Technical Service by calling 1-855-336-4034. **Please note that you will be asked to provide proof of initial purchase when calling.** If a product requires further inspection, the Technical Service representative will explain and assist with any additional action needed. Powermatic has Authorized Service Centers located throughout the United States. For the name of an Authorized Service Center in your area call 1-855-336-4034 or use the Service Center Locator on the Powermatic website.

### More Information

Powermatic is constantly adding new products. For complete, up-to-date product information, check with your local distributor or visit the Powermatic website.

### How State Law Applies

This warranty gives you specific legal rights, subject to applicable state law.

### Limitations on This Warranty

POWERMATIC LIMITS ALL IMPLIED WARRANTIES TO THE PERIOD OF THE LIMITED WARRANTY FOR EACH PRODUCT. EXCEPT AS STATED HEREIN, ANY IMPLIED WARRANTIES OF MERCHANTABILITY AND FITNESS FOR A PARTICULAR PURPOSE ARE EXCLUDED. SOME STATES DO NOT ALLOW LIMITATIONS ON HOW LONG AN IMPLIED WARRANTY LASTS, SO THE ABOVE LIMITATION MAY NOT APPLY TO YOU. POWERMATIC SHALL IN NO EVENT BE LIABLE FOR DEATH, INJURIES TO PERSONS OR PROPERTY, OR FOR INCIDENTAL, CONTINGENT, SPECIAL, OR CONSEQUENTIAL DAMAGES ARISING FROM THE USE OF OUR PRODUCTS. SOME STATES DO NOT ALLOW THE EXCLUSION OR LIMITATION OF INCIDENTAL OR CONSEQUENTIAL DAMAGES, SO THE ABOVE LIMITATION OR EXCLUSION MAY NOT APPLY TO YOU.

Powermatic sells through distributors only. The specifications listed in Powermatic printed materials and on the official Powermatic website are given as general information and are not binding. Powermatic reserves the right to effect at any time, without prior notice, those alterations to parts, fittings, and accessory equipment which they may deem necessary for any reason whatsoever.

### Product Listing with Warranty Period

90 Days – Parts; Consumable items
1 Year – Motors, Machine Accessories
2 Year – Woodworking Machinery used for industrial or commercial purposes
5 Year – Woodworking Machinery

NOTE: Powermatic is a division of JPW Industries, Inc. References in this document to Powermatic also apply to JPW Industries, Inc., or any of its successors in interest to the Powermatic brand.

This page intentionally left blank.



427 New Sanford Road  
LaVergne, Tennessee 37086  
Phone: 800-274-6848  
[www.powermatic.com](http://www.powermatic.com)