



Pneumatic Screwdriver

#505650, JAT-650

#505651, JAT-651

After s/n 15050201



Operation & Parts Manual

M-505650

Edition 5

10/2021



Stock No.:
Serial No.:
Purchased from:
Date purchased:

JET
427 New Sanford Road
LaVergne, TN 37086
Ph.: 800-274-6848
www.jettools.com

Copyright © 2017 JET

Warranty and Service

JET® warrants every product it sells against manufacturers' defects. If one of our tools needs service or repair, please contact Technical Service by calling 1-800-274-6846, 8AM to 5PM CST, Monday through Friday.

Warranty Period

The general warranty lasts for the time period specified in the literature included with your product or on the official JET branded website.

- JET products carry a limited warranty which varies in duration based upon the product. (See chart below)
- Accessories carry a limited warranty of one year from the date of receipt.
- Consumable items are defined as expendable parts or accessories expected to become inoperable within a reasonable amount of use and are covered by a 90 day limited warranty against manufacturer's defects.

Who is Covered

This warranty covers only the initial purchaser of the product from the date of delivery.

What is Covered

This warranty covers any defects in workmanship or materials subject to the limitations stated below. This warranty does not cover failures due directly or indirectly to misuse, abuse, negligence or accidents, normal wear-and-tear, improper repair, alterations or lack of maintenance. JET woodworking machinery is designed to be used with Wood. Use of these machines in the processing of metal, plastics, or other materials outside recommended guidelines, may void the warranty. The exceptions are acrylics and other natural items that are made specifically for wood turning.

Warranty Limitations

Woodworking products with a Five Year Warranty that are used for commercial or industrial purposes default to a Two Year Warranty. Please contact Technical Service at 1-800-274-6846 for further clarification.

How to Get Technical Support

Please contact Technical Service by calling 1-800-274-6846. **Please note that you will be asked to provide proof of initial purchase when calling.** If a product requires further inspection, the Technical Service representative will explain and assist with any additional action needed. JET has Authorized Service Centers located throughout the United States. For the name of an Authorized Service Center in your area call 1-800-274-6846 or use the Service Center Locator on the JET website.

More Information

JET is constantly adding new products. For complete, up-to-date product information, check with your local distributor or visit the JET website.

How State Law Applies

This warranty gives you specific legal rights, subject to applicable state law.

Limitations on This Warranty

JET LIMITS ALL IMPLIED WARRANTIES TO THE PERIOD OF THE LIMITED WARRANTY FOR EACH PRODUCT. EXCEPT AS STATED HEREIN, ANY IMPLIED WARRANTIES OF MERCHANTABILITY AND FITNESS FOR A PARTICULAR PURPOSE ARE EXCLUDED. SOME STATES DO NOT ALLOW LIMITATIONS ON HOW LONG AN IMPLIED WARRANTY LASTS, SO THE ABOVE LIMITATION MAY NOT APPLY TO YOU.

JET SHALL IN NO EVENT BE LIABLE FOR DEATH, INJURIES TO PERSONS OR PROPERTY, OR FOR INCIDENTAL, CONTINGENT, SPECIAL, OR CONSEQUENTIAL DAMAGES ARISING FROM THE USE OF OUR PRODUCTS. SOME STATES DO NOT ALLOW THE EXCLUSION OR LIMITATION OF INCIDENTAL OR CONSEQUENTIAL DAMAGES, SO THE ABOVE LIMITATION OR EXCLUSION MAY NOT APPLY TO YOU.

JET sells through distributors only. The specifications listed in JET printed materials and on official JET website are given as general information and are not binding. JET reserves the right to effect at any time, without prior notice, those alterations to parts, fittings, and accessory equipment which they may deem necessary for any reason whatsoever. JET® branded products are not sold in Canada by JPW Industries, Inc.

Product Listing with Warranty Period

90 Days – Parts; Consumable items
1 Year – Motors; Machine Accessories
2 Year – Metalworking Machinery; Electric Hoists, Electric Hoist Accessories; Woodworking Machinery used for industrial or commercial purposes
5 Year – Woodworking Machinery
Limited Lifetime – JET Parallel clamps; VOLT Series Electric Hoists; Manual Hoists; Manual Hoist Accessories; Shop Tools; Warehouse & Dock products; Hand Tools; Air Tools

NOTE: JET is a division of JPW Industries, Inc. References in this document to JET also apply to JPW Industries, Inc., or any of its successors in interest to the JET brand.



Safety warnings

General air tool warnings

1. Read and understand this entire manual before attempting assembly or operation.
2. Read and understand all warnings posted on the tool and in this manual. Failure to comply with all of these warnings may cause serious injury.
3. Replace warning labels if they become obscured or removed.
4. Do not use this tool for other than its intended use. If used for other purposes, JET disclaims any real or implied warranty and holds itself harmless from any injury that may result from that use.
5. Always wear approved safety glasses or face shield while using this tool. (Everyday eyeglasses only have impact resistant lenses; they are *not* safety glasses.)
6. Wear ear protectors (plugs or muffs) if the noise exceeds safe levels.
7. Wear gloves and protective clothing if operation produces sparks or flying particles. Gloves should be tight-fitting, without frayed fingers or hanging threads. Keep hands and body away from the working area of tool.
8. Do not operate an air tool continually at full throttle without a work load on the tool.
9. The air tool must be properly lubricated before operating.
10. Never start a percussion type air tool (chipper, breaker, buster, etc.) without securing the tooling in the retainer and placing the tip against the work surface.
11. Do not operate air tool without its guards in place. Do not modify the tool.
12. Do not operate this tool while tired or under the influence of drugs, alcohol, or any medication.
13. Adopt a comfortable posture with proper balance, and maintain secure footing at all times. Non-slip footwear or anti-skid floor strips are recommended.
14. Do not wear loose clothing or jewelry. Confine long hair.
15. Excessive air pressure and too much free rotation may decrease life of the tool and may cause a hazardous situation.
16. Check air hoses for wear, and keep them away from heat and sharp edges. Repair or replace damaged air hose immediately. Do not carry tool by the air hose.
17. Air hose may cause tripping hazards; keep hose away from traffic areas.
18. Do not use this tool near flammable objects, or in potentially explosive environments. Do not use near live electrical wires.
19. Do not use power tools in damp or wet location, or expose them to rain. Keep work area well lighted.
20. Do not leave a connected tool unattended. When not in use, disconnect tool from air source.
21. Shut off air supply and discharge any residual pressure from tool before removing hose, making adjustments, changing accessories, or storing tool.
22. Make sure tool is switched off, and your finger off the trigger, before connecting to air supply.
23. Remove adjusting keys and wrenches before turning on tool.
24. Keep visitors a safe distance from the work area. *Keep children away.*

25. Give your work undivided attention. Looking around, carrying on a conversation and “horse-play” are careless acts that can result in serious injury.
26. Do not force a tool or attachment to do a job for which it was not designed. The right tool will do the job better and more safely.
27. Repetitive motions and/or exposure to constant vibration can be harmful to hands and arms. Take frequent breaks and relax hands during extended operation. Change posture to avoid discomfort or fatigue.
28. Compressed air can be harmful if directed toward sensitive areas of the body, and may propel small particles caught in the air stream. Exercise proper caution.
29. Use only recommended accessories; improper accessories may be hazardous.
30. Maintain tools with care. Keep air tool clean and oiled for best and safest performance.
31. Do not use combustible gases, carbon dioxide, oxygen or any bottled gas as an air source for the tool. These can present risk of explosion and serious injury.
32. Do not lubricate the tool with combustible liquids, such as kerosene, diesel or jet fuel.
33. Do not dispose of this tool with normal household waste. Never dispose of the air tool into fire.

Specific warnings for Screwdrivers

34. This pneumatic screwdriver is designed for insertion and removal of screws and similar fasteners. If you are not familiar with the proper and safe operation of a pneumatic screwdriver, do not use until proper training and knowledge have been obtained.
35. Secure workpiece with clamps or vise; do not hold workpiece by hand.
36. Only use accessories that are intended for use with a pneumatic screwdriver, and which match the chuck size of the tool.

37. Screwdriver bits should be clean and in good condition.

 **WARNING:** This product can expose you to chemicals including lead which is known to the State of California to cause cancer and birth defects or other reproductive harm. For more information go to <http://www.p65warnings.ca.gov>.

 **WARNING:** Some dust, fumes and gases created by power sanding, sawing, grinding, drilling, welding and other construction activities contain chemicals known to the State of California to cause cancer and birth defects or other reproductive harm. Some examples of these chemicals are:

- lead from lead based paint
- crystalline silica from bricks, cement and other masonry products
- arsenic and chromium from chemically treated lumber

Your risk of exposure varies, depending on how often you do this type of work. To reduce your exposure to these chemicals, work in a well-ventilated area and work with approved safety equipment, such as dust masks that are specifically designed to filter out microscopic particles. For more information go to <http://www.p65warnings.ca.gov/> and <http://www.p65warnings.ca.gov/wood>.

Familiarize yourself with the following safety notices used in this manual:

 **WARNING** This means that if precautions are not heeded, it may result in serious, or even fatal, injury.

 **CAUTION** This means that if precautions are not heeded, it may result in minor injury and/or possible tool damage.

About this manual

This manual is provided by JET, covering the safe operation and maintenance procedures for a JET Model JAT-650 and JAT-651 Pneumatic Screwdriver. This manual contains instructions on safety precautions, general operating procedures, maintenance procedures and parts breakdown. Your tool has been designed and constructed to provide consistent, long-term operation if used in accordance with the instructions set forth in this document.

The instructions and warnings in this manual may not encompass all possible workplace environments. The operator is expected to take appropriate precautions and exercise common sense. As with any tool operation, safety of operator and bystanders should be first priority.

If there are questions or comments, please contact your local supplier or JET. JET can also be reached at our web site: www.jettools.com.

Record the serial number and purchase information of your tool on the cover of this manual for quick access. Retain this manual for future reference. If the tool transfers ownership, the manual should accompany it.

Register your product using the mail-in card provided, or register online:

<http://www.jettools.com/us/en/service-and-support/product-registration/>

Tool specifications

Model number	JAT-650	JAT-651
Stock number	505650	505651
Chuck size and type	1/4 in. hex bit; positive clutch	1/4 in. hex bit; positive clutch
Horsepower	1/2	1/2
Maximum torque	145 in.lbs.	115 in.lbs.
Free speed	800 RPM	1800 RPM
Average air consumption	4 CFM	4 CFM
Air inlet	1/4 in. NPT	1/4 in. NPT
Air hose inside diameter	3/8 in.p	3/8 in.
Required air pressure	90 psi (621 kPa)	90 psi (621 kPa)
Vibration value	0.3 m/s ²	0.2 m/s ²
Noise level ¹	100 dB(A)	95 dB(A)
Rotation direction	Forward and reverse	Forward and reverse
Power setting	Variable speed trigger	Variable speed trigger
Grip	Pistol style	Pistol style
Overall Length	7-3/8 in. (22.23 mm)	7-3/16 in. (182.56 mm)
Housing material	Aluminum with rubber grip	Aluminum with rubber grip
Net weight	2.76 lb. (1.25 kg)	2.69 lb. (1.22 kg)
Shipping weight	3.12 lb. (1.42 kg)	3.04 lb. (1.38 kg)

¹ The specified values are emission levels and are not necessarily to be seen as safe operating levels. As workplace conditions vary, this information is intended to allow the user to make a better estimation of the hazards and risks involved only.

Specifications were current at time of publication, but because of our policy of continuous improvement, JET reserves the right to change specifications at any time and without prior notice, without incurring obligations.

Setup and Assembly

Any missing parts or damage should be reported immediately to your JET® distributor. Do not use a damaged tool. Read this instruction manual thoroughly for operation, maintenance and safety instructions.

Box contents:

- 1 Pneumatic screwdriver
- 1 Operation and parts manual
- 1 Warranty card

Operation

CAUTION The pneumatic screwdriver must be properly lubricated before operation. See “Lubrication” section.

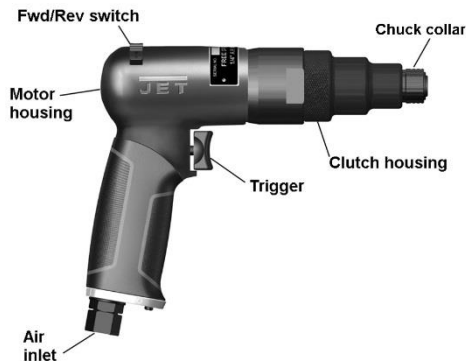

Figure 1

1. Remove protective cap from air inlet (Figure 1). If an in-line oiler is not being used, add 4 or 5 drops of air tool oil (not included) in to the air inlet.
2. Blow out air line to remove any dirt or moisture, then connect air supply hose to tool. Set air pressure to 90 psi.

IMPORTANT: Connecting a quick-change coupling directly to the tool is not recommended, as vibration may cause the connection to fail. Instead, add a leader hose and install any quick-change couplings farther down the line.

3. Push chuck collar forward. Insert bit as far as it will go, and release chuck collar.
4. Use selector switch for rotation direction (F/R).
5. Gently press trigger. Speed is variable, determined by pressure against trigger.
6. Release trigger to stop screwdriver.
7. Push chuck collar forward to remove bit.

Maintenance

Lubrication

The screwdriver should be lubricated **daily** (or before each use) with air tool oil through the air inlet. During continual operation, it should be re-oiled every 1 to 2 hours. This can be done with an in-line oiler, or manually. If done manually, proceed as follows:

1. Disconnect air hose from tool.
2. Place 4 or 5 drops of air tool oil into air inlet.

NOTE: Air tool oil not provided; it is available at most major hardware and tool stores. SAE #10 oil or sewing machine oil may be used as a substitute. Do not use detergent oil.
3. Re-connect air. Run screwdriver at low throttle without load for a few seconds to distribute the oil throughout tool.
4. When finished operating screwdriver, disconnect air hose. Wipe off housing with a dry cloth. Place 4 or 5 drops of air tool oil into air inlet; re-connect air and run tool for a few seconds to distribute the oil. Disconnect air.

Storage

Avoid storing the screwdriver in very humid locations which promotes rusting of internal mechanisms. Always oil the tool and disconnect air hose before storage.

Air system requirements

1. Use proper air hose size (refer to tool specifications). The hose should be just long enough to serve the working area. Excessive hose length will cause pressure drop.

2. Make sure air compressor supplies clean, dry air at correct CFM for the tool.
3. Set air pressure to 90 psi.



Excess air pressure and/or unclean air will shorten the tool's life and may create a hazardous situation.

4. Drain water from air compressor tank daily, as well as any condensation from air lines. Water in the air line may enter the tool and cause damage.
5. Change filters on the air system on a regular basis.
6. Air-line pressure may be increased accordingly to compensate for extra-long air hoses (usually over 25 feet). Inside diameter of hose should be minimum 3/8-inch.

General Air Tool Information

If the air tool is not performing according to specifications, the following are among the most common causes. (See also "Troubleshooting" section.)

- Contaminated air such as a dirty air system or water in the system.
- Using wrong size tool for the job.
- Poor maintenance practices, such as using excessive air pressure or air volume.
- Improper or no lubrication.

Rule of Thumb

If it takes more than 8 seconds to tighten or loosen a bolt or nut with an air impact wrench at maximum setting, the air wrench is too small or the air compressor CFM is not powerful enough for the job. Continued use in either capacity will cause damage to the tool.

Tool Pressure

JET Air Tools operate on 70-to-100 psi (pounds per square inch) air pressure measured at the tool when the tool is operating. Set tool to 90 psi unless indicated otherwise. Pressure in excess of 100 psi will shorten the life of the tool.

Air System Recommendations

Equip the air compressor intake with a replaceable air filter that can be easily cleaned.

Use safety shut-off valves so air flow can be stopped quickly in case of a line break.

When using multiple hoses, air hoses should be larger than leader hose. Join multiple hoses directly, rather than with quick connect fittings which may cause pressure drops and tool power reduction.

Use anti-whip devices across hose couplings to prevent hose from whipping in the event of a hose failure or coupling disconnect.

Always use moisture traps at the compressor for the main distribution line. Use moisture traps and in-line oilers on each downline that is to be used for air tools. (See Figure 2). Place oiler as close to air tool as possible for best lubrication.

Lubrication

Use a light oil containing rust inhibitors, such as SAE #10. Many JET air tools have integral oil reservoirs, which should be kept filled when in-line oilers are not used.

If greasing is required, use a grease that is highly water resistant for front case components on air impact wrenches, grinders and sanders.

Recycling

Protect the environment. Your tool contains materials which can be recovered or recycled. When its useful life has expired, please leave tool at a specialized facility.

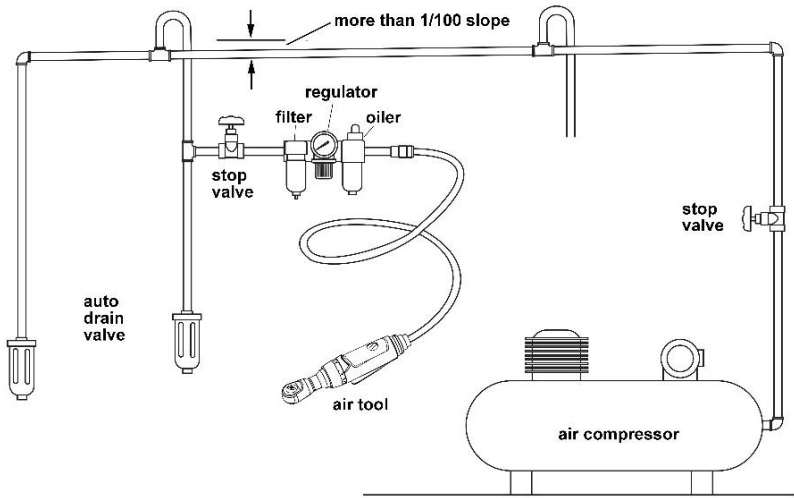

Figure 2

Recommended arrangement of air piping and air line system

Troubleshooting JAT-650/651 Screwdriver

Any disassembly of the tool should be done by qualified service personnel. For problems not addressed below, contact JET technical service at 800-274-6846.

Problem	Possible cause	Remedy
Tool will not start.	Air valve closed or obstructed.	Open valve; clear any obstructions.
	Dirt or gum deposits on components.	Flush tool with gum solvent. If problem persists, disassemble, clean and lubricate internal parts.
	Rotor vanes or other components are worn.	Replace worn components. (Replace vanes as an entire set.)
	Trigger inoperable.	Clean trigger mechanism to ensure free movement. Replace mechanism if needed.
	Bearing(s) worn.	Disassemble and inspect bearing. Grease or replace as needed.
Excessive or abnormal vibration.	Bearings worn.	Disassemble and inspect bearing. Grease or replace as needed.
Loss of power; erratic action.	Low air pressure.	Verify compressor has proper CFM rating for tool. Check compressor regulator setting; set air pressure to 90 psi. Set regulator dial on tool to maximum setting. Check for loose connections.
	Moisture or obstruction in air hose.	Air supply must be clean and dry. Clean out air hose(s) and remove any kinks or bends.
	Improper size of air transmission lines, hoses, fittings, or couplings.	Use appropriate-sized air lines/hoses. Verify proper fittings/couplings.
	Dirt or gum deposits on components.	Flush tool with gum solvent. Check and clean air filter on compressor. Clean external areas of tool. If problem persists, disassemble, clean and lubricate internal parts.
	Rotor vanes are worn.	Replace vanes (entire set).
Housing becomes hot during operation.	Insufficient lubrication.	Lubricate with air tool oil.
	Worn components.	Replace components as needed.
Severe air leakage. (Note: Minimal escape of air is often normal for air tools.)	Air valve obstructed or damaged.	Clean or replace.
	Housing loose or damaged.	Tighten or replace as needed.

Replacement parts

Service parts are listed on the following pages. To order parts or reach our service department, call 1-800-274-6848 Monday through Friday, 8:00 a.m. to 5:00 p.m. CST. Please have the stock number and serial number of your tool available when you call, so that we may serve you quickly and accurately.

Non-proprietary parts, such as fasteners, can be found at local hardware stores, or may be ordered from JET. Some parts are shown for reference only, and may not be available individually.

#505650, JAT-650, 1/4-inch Screwdriver – exploded view

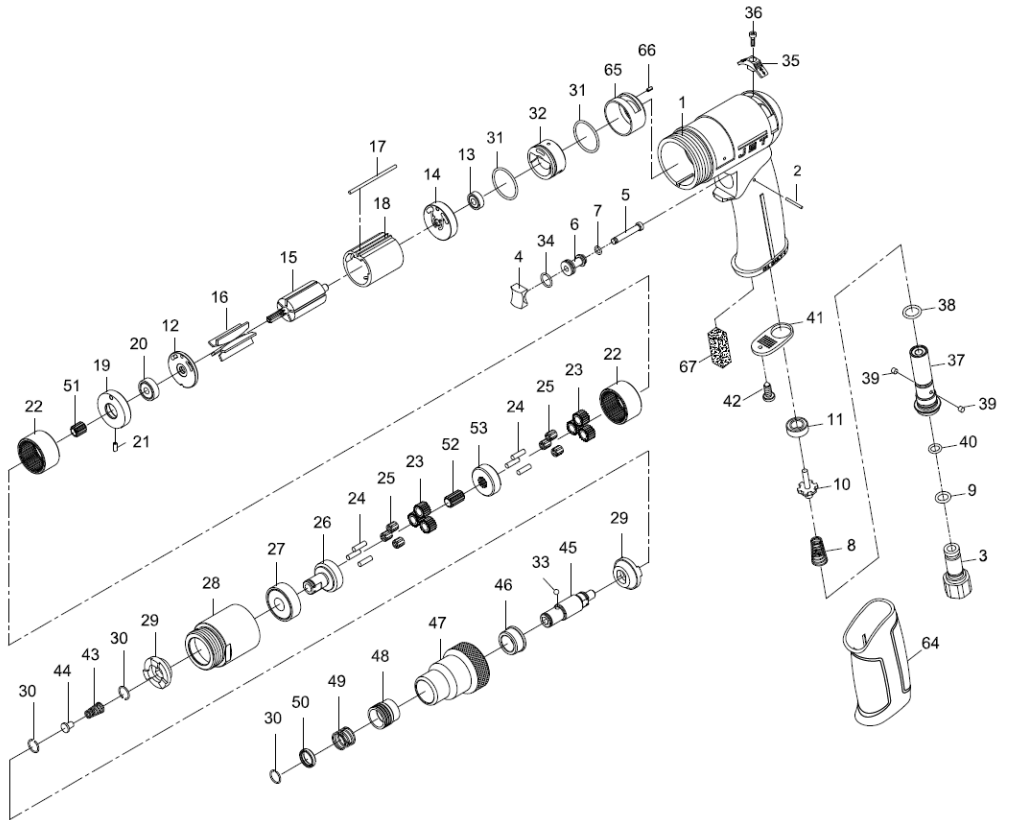

#505650, JAT-650, 1/4-inch Screwdriver – parts list

Index	Part No.	Description	Qty
1	JAT610-01	Motor housing	1
2	JSM7572-02	Pin 2x18.8	1
3	JSM7572-03	Air inlet	1
4	JSM7572-04	Trigger	1
5	JSM7572-05	Valve stem	1
6	JSM7572-06	Valve bushing	1
7	40333-12	O-Ring 6x1.5	1
8	73108	Valve spring	1
9	70109NPN	O-Ring 9.8x1.9	1
10	JSM7572-146	Valve stem	1
11	JSM7572-145	Rubber spacer	1
12	80214	End plate	1
13	BB-696ZZ	Ball bearing 696ZZ	1
14	JSM7572-14	Rear end plate	1
15	80215	Rotor	1
16	JSM7572-16	Rotor vane	5
17	JSM7572-17	Pin 2.5x55	1
18	JSM7572-18	Cylinder	1
19	JSM7572-19	Front end plate	1
20	BB-626ZZ	Ball bearing 626ZZ	1
21	70117	Spring pin 2x5L	1
22	80222	Internal gear	2
23	70423-14	Planet gear	6
24	30124	Pin 4x13.8L	6
25	70428	Needle bearing 4x6x8	6
26	80226	Work spindle	1
27	BB-6201Z	Ball bearing 6201Z	1
28	80328	Clamp nut	1
29	80429	Drive dog	2

Index	Part No.	Description	Qty
30	80230	Retaining ring	3
31	JSM3330-49	O-Ring 26.7x1.78	2
32	JSM7572-32	Reversing valve	1
33	SB-1/8	Steel ball 1/8in.	1
34	80209	O-Ring 12x1.6	1
35	JSM7572-35	Reversing valve knob	1
36	JSM7572-36	Screw M3x10	1
37	JSM7572-37	Fixed shaft	1
38	JSM7572-38	O-Ring 10.8x2	1
39	JSM7572-39	Pin 3x3	2
40	JSM3330-46	O-Ring 7.5x1.5	1
41	JSM7572-41	Exhaust diffuser	1
42	JSM7572-42	Screw TS2.9	1
43	80220	Spring	1
44	80221	Spring guide	1
45	80432	Cam spindle	1
46	80435	Clutch bushing	1
47	80436	Clutch housing	1
48	80242	Ball retainer	1
49	80243	Spring	1
50	80244	Washer	1
51	SM-70420	Pinion gear	1
52	SM-70421	Center gear	1
53	SM-70427	Reduction spindle	1
64	JSM7572-64	Rubber grip	1
65	JSM7572-65	Reverse valve case	1
66	JSM5430-42	Spring pin 2x4L	1
67	JSM7572-67	Damping material	1

JAT650-RPK, Repair Kit, contains 7,16(5),31(2),34,38

JAT650-RBK, Rebuild Kit, contains 14,17,18,19,23(6),25(6)

#505651, JAT-651, 1/4-inch Screwdriver – exploded view

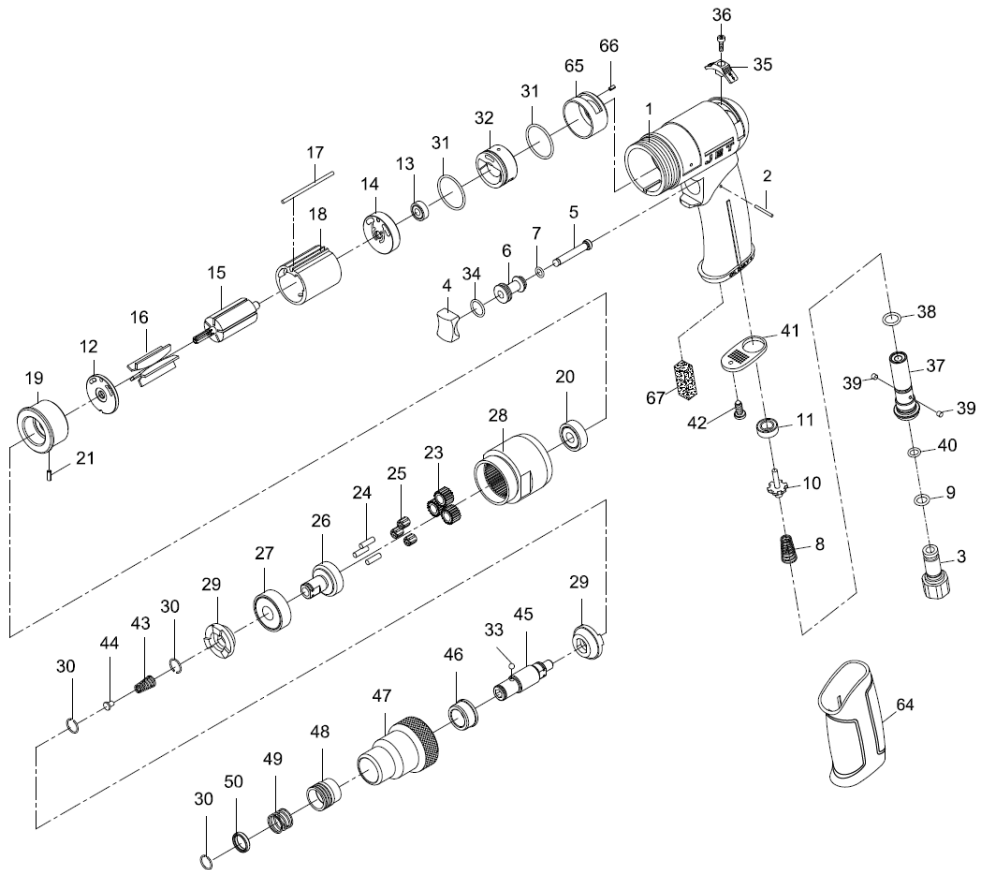

#505651, JAT-651, 1/4-inch Screwdriver – parts list

Index	Part No.	Description	Qty
1	JAT610-01	Motor housing	1
2	JSM7572-02	Pin 2x18.8	1
3	JSM7572-03	Air inlet	1
4	JSM7572-04	Trigger	1
5	JSM7572-05	Valve stem	1
6	JSM7572-06	Valve bushing	1
7	40333-12	O-Ring 6x1.5	1
8	73108	Valve spring	1
9	70109NPN	O-Ring 9.8x1.9	1
10	JSM7572-146	Valve stem	1
11	JSM7572-145	Rubber spacer	1
12	80214	End plate	1
13	BB-696ZZ	Ball bearing 696ZZ	1
14	JSM7572-14	Rear end plate	1
15	80215	Rotor	1
16	JSM7572-16	Rotor vane	5
17	JSM7572-17	Pin 2.5x55	1
18	JSM7572-18	Cylinder	1
19	JSM7572-19	Front end plate	1
20	BB-626ZZ	Ball bearing 626ZZ	1
21	70117	Spring pin 2x5L	1
22	80222	Internal gear	1
23	80223-14	Planet gear	3
24	30124	Pin 4x13.8L	3
25	80245	Needle bearing 4x7x8	3
26	80426	Work spindle	1
27	BB-6201Z	Ball bearing 6201Z	1

Index	Part No.	Description	Qty
28	JAT661-28	Clamp nut	1
29	80429	Drive dog	2
30	80230	Retaining ring	3
31	JSM3330-49	O-Ring 26.7x1.78	2
32	JSM7572-32	Reversing valve	1
33	SB-1/8	Steel ball 1/8in.	1
34	80209	O-Ring 12x1.6	1
35	JSM7572-35	Reversing valve knob	1
36	JSM7572-36	Screw M3x10	1
37	JSM7572-37	Fixed shaft	1
38	JSM7572-38	O-Ring 10.8x2	1
39	JSM7572-39	Pin 3x3	2
40	JSM3330-46	O-Ring 7.5x1.5	1
41	JSM7572-41	Exhaust diffuser	1
42	JSM7572-42	Screw TS2.9	1
43	80220	Spring	1
44	80221	Spring guide	1
45	80432	Cam spindle	1
46	80435	Clutch bushing	1
47	80436	Clutch housing	1
48	80242	Ball retainer	1
49	80243	Spring	1
50	80244	Washer	1
64	JSM7572-64	Rubber grip	1
65	JSM7572-65	Reverse valve case	1
66	JSM5430-42	Spring pin 2x4L	1
67	JSM7572-67	Damping material	1

JAT650-RPK, Repair Kit, contains 7,16(5),31(2),34,38

JAT651-RBK, Rebuild Kit, contains 14,17,18,19,23(3),25(3)



427 New Sanford Road
LaVergne, Tennessee 37086
Phone: 800-274-6848
www.jettools.com