

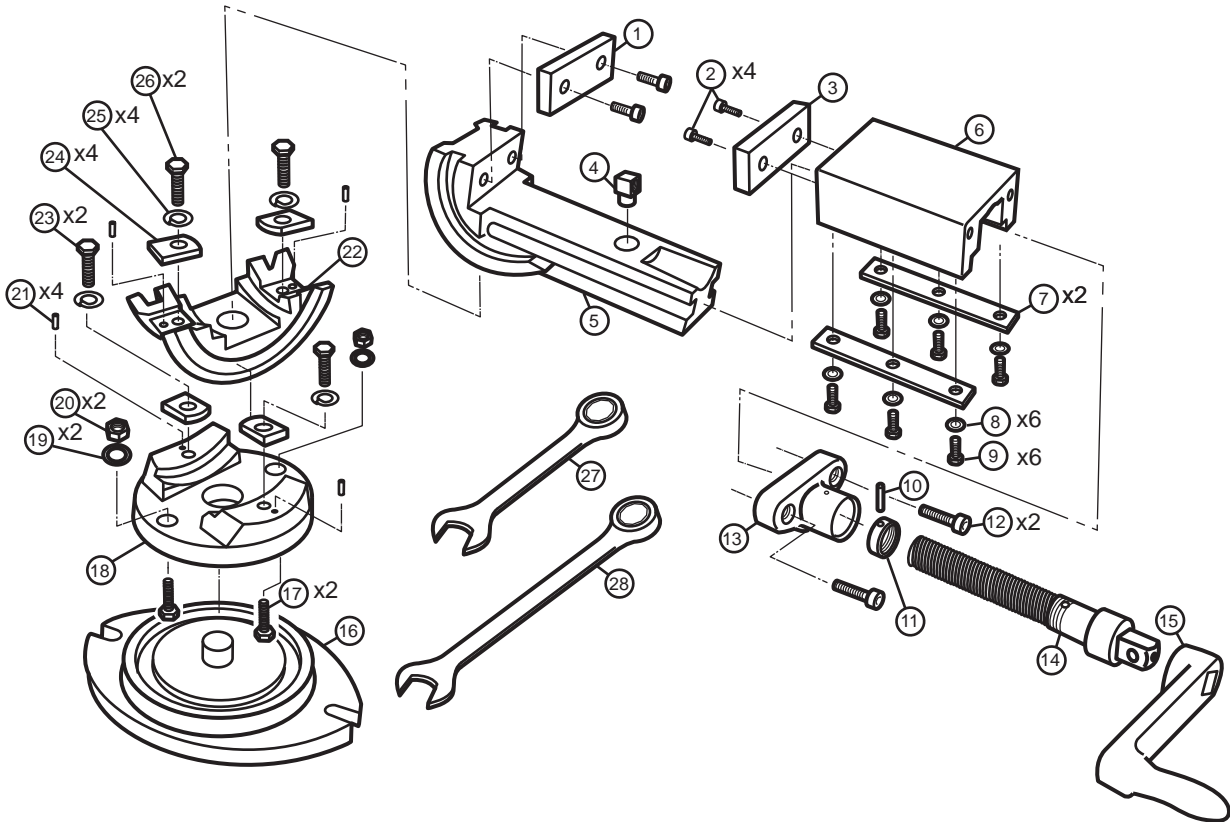

Super Precision 3-Axis Tilting Machine Vise Parts Diagram

3" Jaw Width, 3" Jaw Opening, 1-5/16" Jaw Depth

Stock #: 11701 Model #: TLT/SP-75



#	Part	Description	Qty
1	11701-01	Fixed Jaw Insert	1
2	11701-02	Socket Head Cap Screw	4
3	11701-03	Movable Jaw Insert	1
4	11701-04	Fixed Nut	1
5	11701-05	Vise Body	1
6	11701-06	Movable Jaw	1
7	11701-07	Slide Plate	2
8	11701-08	Flat Washer	6
9	11701-09	Hex Cap Screw	6
10	11701-10	Roll Pin	1
11	11701-11	Collar	1
12	11701-12	Socket Head Cap Screw	2
13	11701-13	Sleeve	1
14	11701-14	Clamp Screw	1

#	Part	Description	Qty
15	11701-15	Handle	1
16	11701-16	Swivel Base	1
17	11701-17	Hex Cap Screw	2
18	11701-18	Turret	1
19	11701-19	Flat Washer	2
20	11701-20	Hex Nut	2
21	11701-21	Pin	4
22	11701-22	Trunnion	1
23	11701-23	Hex Cap Screw	2
24	11701-24	Curved Washer	4
25	11701-25	Lock Washer	4
26	11701-26	Hex Cap Screw	2
27	11701-27	Combination Wrench	1
28	11701-28	Combination Wrench	1

WARNING: This product can expose you to chemicals including lead which is known to the State of California to cause cancer and birth defects or other reproductive harm. For more information go to <http://www.p65warnings.ca.gov>.

WILTON

427 New Sanford Road
 LaVergne, Tennessee 37086
 Ph.: 800-274-6848
www.wiltontools.com

Part No. M-11701
 Edition 2 08/2018

Copyright © 2018 WILTON, a Division of JPW Industries, Inc.