

# 2-Post Lift Operations and Maintenance Manual

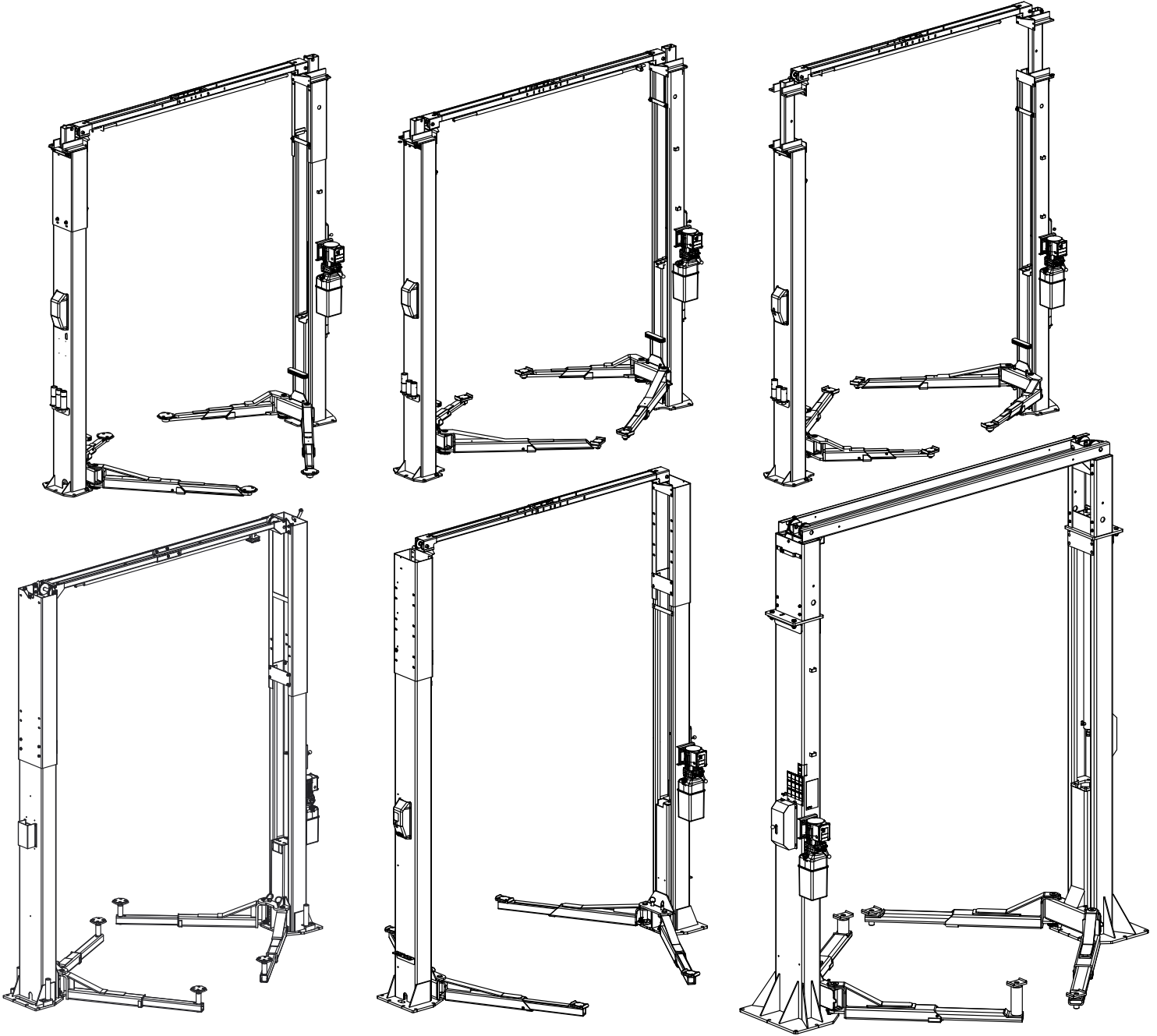

## Table Of Contents

Safety Instructions .....	2
Owner/Employer Responsibilities / Operating Conditions .....	3
Operating Instructions .....	4
Maintenance Instructions .....	7
Trouble Shooting .....	8
Lift Lockout/Tagout Procedure .....	9

*Installer: Please return this booklet to literature package and give to lift owner/operator.*

# IMPORTANT SAFETY INSTRUCTIONS

**SAFETY INSTRUCTIONS**

Proper maintenance and inspection is necessary for safe operation. ©

**SAFETY INSTRUCTIONS**

Do not operate a damaged lift. ©

**CAUTION**

Lift to be used by trained operator only. ©

**CAUTION**

Authorized personnel only in lift area. ©

**SAFETY INSTRUCTIONS**

Read operating and safety manuals before using lift. ©

**WARNING**

Position vehicle with center of gravity midway between adapters. ©

**CAUTION**

Use vehicle manufacturer's lift points. ©

**WARNING**

Do not override self-closing lift controls. ©

**WARNING**

Position vehicle with center of gravity midway between adapters. ©

**WARNING**

Remain clear of lift when raising or lowering vehicle. ©

**CAUTION**

Always use safety stands when removing or installing heavy components. ©

**WARNING**

Avoid excessive rocking of vehicle while on lift. ©

**WARNING**

Clear area if vehicle is in danger of falling. ©

**CAUTION**

Auxiliary adapters may reduce load capacity. ©

- Read all instructions.
- Daily inspect your lift. Never operate if it malfunctions or if it has broken or damaged parts. Use only qualified lift service personnel and genuine parts to make repairs.
- Thoroughly train all employees in use and care of lift, using manufacturer's instructions and "Lifting It Right" and "Safety Tips" supplied with the lift.
- Never allow unauthorized or untrained persons to position vehicle or operate lift.
- Prohibit unauthorized persons from being in shop area while lift is in use.
- Do Not permit anyone on lift or inside vehicle when it is either being raised or lowered.
- Always keep area around lift free of tools, debris, grease and oil.
- Never overload lift. Capacity of lift is shown on nameplate affixed to the lift.
- Do Not stand in front of the vehicle while it is being positioned in lift bay.
- Do Not hit or run over lift arms or adapters. This could damage lift or vehicle. Before driving vehicle into lift bay, position arms and adapters to provide unobstructed entrance onto lift.
- Load vehicle on lift carefully. Position lift adapters to contact at the vehicle manufacturer's recommended lift points. Raise lift until adapters contact vehicle. Check adapters for secure contact with vehicle. Raise lift to desired working height.

**CAUTION** DO NOT go under vehicle if locking latches are not engaged.

- Do Not block open or override self-closing lift controls; they are designed to return to the "Off" or Neutral position when released.
- Do Not remove or disable arm restraints.
- Remain clear of lift when raising or lowering vehicle.
- Always use safety stands when removing or installing heavy components.
- Avoid excessive rocking of vehicle while on lift.
- Clear area if vehicle is in danger of falling.
- Remove tool trays, stands, etc. before lowering lift.
- Release locking latches before attempting to lower lift.
- Position lift arms and adapters to provide an unobstructed exit before removing vehicle from lift area.

**SAVE THESE INSTRUCTIONS.**

The Owner/Employer:



- Shall ensure that lift operators are qualified and that they are trained in the safe use and operation of the lift using the manufacturer’s operating instructions; ALI/SM01-1, ALI Lifting it Right safety manual; ALI/ST-90 ALI Safety Tips card; ANSI/ALI ALOIM-2008, American National Standard for Automotive Lifts-Safety Requirements for Operation, Inspection and Maintenance; ALI/WL Series, ALI Uniform Warning Label Decals/Placards; and in the case of frame engaging lifts, ALI/LP-GUIDE, Vehicle Lifting Points/Quick Reference Guide for Frame Engaging Lifts.
- Shall establish procedures to periodically inspect the lift in accordance with the lift manufacturer’s instructions or ANSI/ALI ALOIM-2008, American National Standard for Automotive Lifts-Safety Requirements for Operation, Inspection and Maintenance; and The Employer Shall ensure that lift inspectors are qualified and that they are adequately trained in the inspection of the lift.
- Shall establish procedures to periodically maintain the lift in accordance with the lift manufacturer’s instructions or ANSI/ALI ALOIM-2008, American National Standard for Automotive Lifts-Safety Requirements for Operation, Inspection and Maintenance; and The Employer Shall ensure that lift maintenance personnel are qualified and that they are adequately trained in the maintenance of the lift.
- Shall maintain the periodic inspection and maintenance records recommended by the manufacturer or ANSI/ALI ALOIM-2008, American National Standard for Automotive Lifts-Safety Requirements for Operation, Inspection and Maintenance.
- Shall display the lift manufacturer’s operating instructions; ALI/SM 93-1, ALI Lifting it Right safety manual; ALI/ST-90 ALI Safety Tips card; ANSI/ALI ALOIM-2008, American National Standard for Automotive Lifts-Safety Requirements for Operation, Inspection and Maintenance; and in the case of frame engaging lifts, ALI/LP-GUIDE, Vehicle Lifting Points/Quick Reference Guide for Frame Engaging Lifts; in a conspicuous location in the lift area convenient to the operator.
- Shall provide necessary lockout/tagout means for energy sources per ANSI Z244.1-1982 (R1993), Safety Requirements for the Lockout/Tagout of Energy Sources, before beginning any lift repairs.
- Shall not modify the lift in any manner without the prior written consent of the manufacturer.

**OPERATING CONDITIONS**

Lift is not intended for outdoor use and has an operating ambient temperature range of 41°-104°F (5°-40°C).

## OPERATING INSTRUCTIONS

### ⚠️ WARNING

To avoid personal injury and/or property damage, permit only trained personnel to operate lift. After reviewing these instructions, get familiar with lift controls by running the lift through a few cycles before loading vehicle on lift.

### 📌 IMPORTANT

Always lift the vehicle using all four adapters. NEVER raise just one end, one corner, or one side of vehicle.

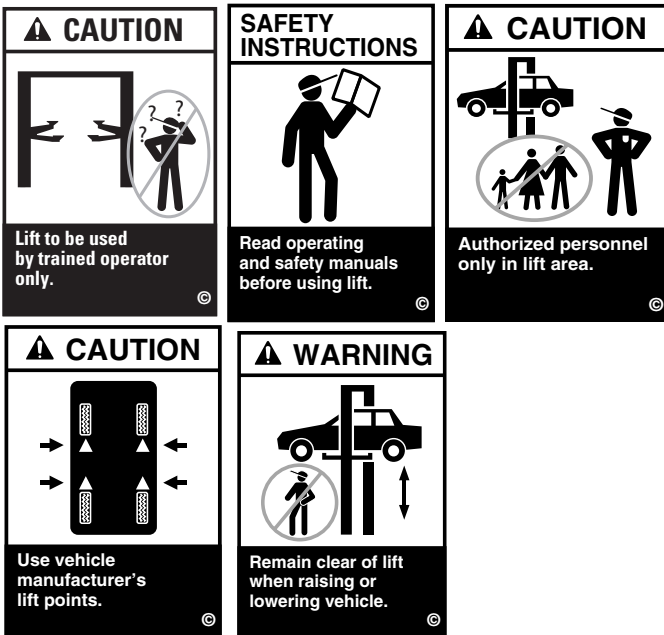

Observe and heed Safety, CAUTION and Warning labels on the lift.

1. Before Loading: Lift must be fully lowered and service bay clear of all personnel before the vehicle is brought on lift. Swing arms out to full drive-thru position.
2. Spot vehicle over lift. Make sure you are using the correct adapter, Fig. 1.
3. Loading: Swing arms under vehicle and position adapters at vehicle manufacturer's recommended lift points, Fig. 2. Use intermediate, high step, or optional adapters for under body clearance when required.

Note: Allow (2) seconds between motor starts. Failure to comply may cause motor burnout.

### 📌 IMPORTANT

DO NOT rest adapter against edge of arm.

\*Maximum operation pressure is:

- 2755 psi for DP10, RTP10
- 3100 psi for I12, F12, R12, RTP12
- 1885-2045 psi for DP15
- 2103-2277 psi for DP18

4. To Raise Lift:
  - A. For all lifts. Push Raise switch on power unit, Fig. 3.
  - B. Stop before making contact with vehicle. Check arm restraint pins for engagement. If required, slightly move arm to allow restraint gear and pawl to mesh. DO NOT hammer pin down as this will damage the restraint gear teeth.
  - C. Raise vehicle until tires clear the floor.
  - D. Stop and check adapters for secure contact at vehicle manufacturer's recommended lift points.
  - E. Continue to raise to desired height only if vehicle is secure on lift.
  - F. Do Not go under vehicle if all four adapters are not in secure contact at vehicle manufacturer's recommended lift points.
  - G. Repeat complete spotting, loading and raising procedures if required.
  - H. Lower lift onto locking latches.

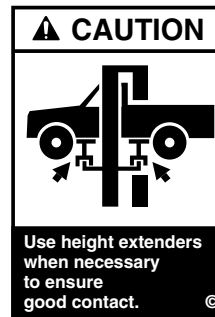

## Adapter Recommendations

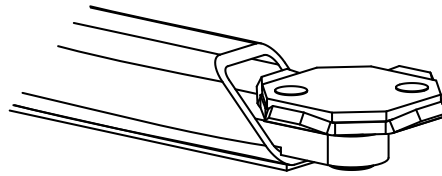

This style adapter recommended for lifting Unibody Vehicles.

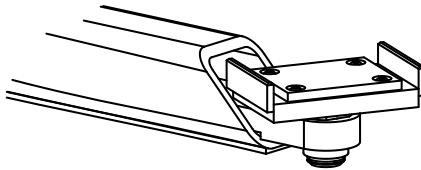

Fig. 1

This style adapter recommended for lifting Frame, Stub Frames, and Perimeter Frame Vehicles.



Most specialty or modified vehicles cannot be raised on a frame engaging lift. Contact vehicle manufacturer for raising or jacking details.

## Typical Lifting Points

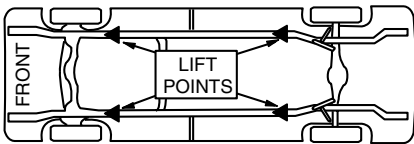

Pickup Truck

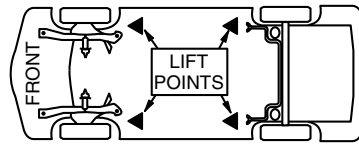

Unitized Body

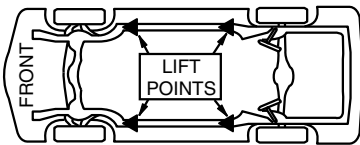

Perimeter Frame

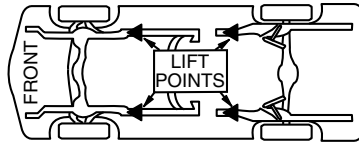

Stub Frame

NOTE: Some vehicles may have the manufacturer's Service Garage Lift Point locations identified by triangle shape marks on it's undercarriage (reference ANSI/SAE J2184-1992). Also, there may be a label located on the right front door lock face showing specific vehicle lift points. If the specific vehicle lift points are not identified, refer to the "Typical Lift Points" illustrated herein. ALWAYS follow the operating instructions supplied with the lift.

Fig. 2

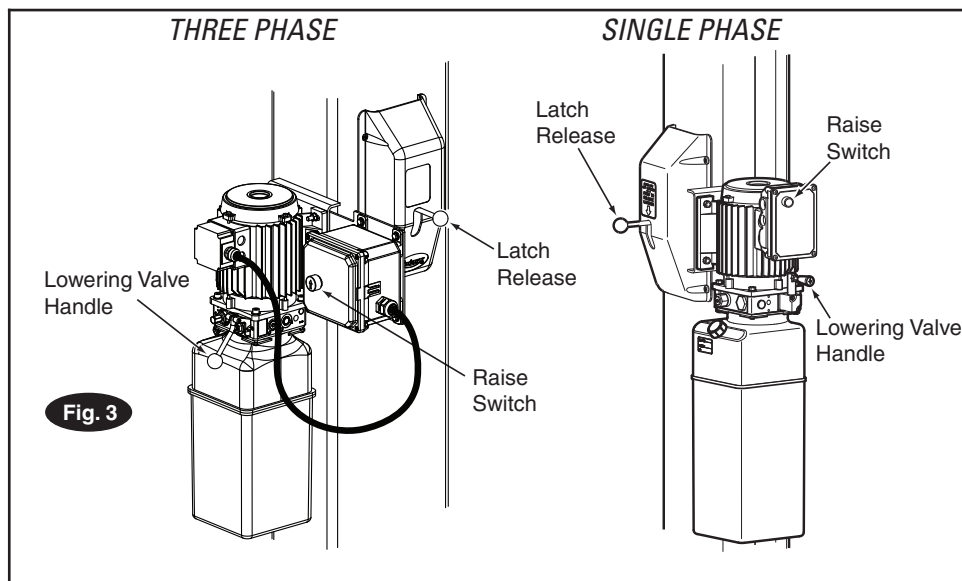

Fig. 3



DO NOT go under vehicle if locking latches are not engaged.



Before attempting to lift pickup trucks or other truck frame vehicles, be sure that:

- A. Vehicle frame is strong enough to support its weight and has not been weakened by modification or corrosion.
- B. Vehicle individual axle weight does not exceed one-half lift capacity.
- C. Adapters are in secure contact with frame at vehicle manufacturers recommended lift points.
- D. Vehicle is stable on lift and neither front nor "tail" heavy.
- E. The overhead switch bar will contact the highest point on the vehicle.

5. While Using Lift:

- A. Avoid excessive rocking of vehicle while on lift.
- B. Always use safety stands as needed or when removing or installing heavy components.

6. To Lower Lift:

- A. Remove all tools or other objects from lift area.
- B. Raise lift off locking latches.
- C. Pull latch release handle fully and hold.
- D. Push lowering valve handle to lower, Fig. 3.

Note: Both latch release and lowering valve handles are deadman-type design. Each must be held down to lower lift. Do not override self-closing lift controls.

- 7. Remain clear of lift when lowering vehicle. Observe pinch point warning decals.
- 8. Remove adapters from under vehicle and swing arms to full drive-thru position before moving vehicle.
- 9. If lift is not operating properly, Do Not use until adjustment or repairs are made by qualified lift service personnel.

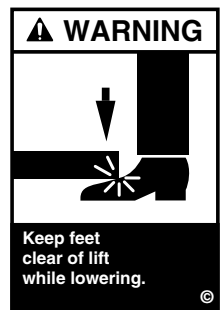
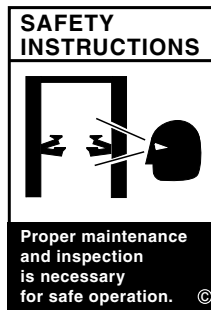
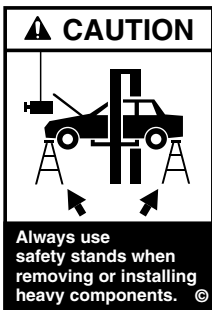
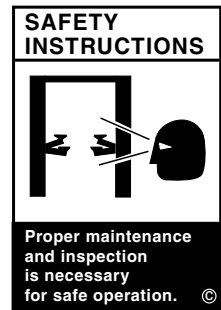

# MAINTENANCE INSTRUCTIONS

If you are not completely familiar with automotive lift maintenance procedures; **STOP**: Contact factory for instructions. To avoid personal injury, permit only qualified personnel to perform maintenance on this equipment.

- Always keep bolts tight. Check periodically.
- Always keep lift components clean.
- Always if oil leakage is observed, call local service representative.
- Always if electrical problems develop, call local service representative.
- Daily: Check cables and sheaves for wear. Observe for frayed cable strands. Wipe cables with a rag to detect hard to see small broken cable strands. Replace cables showing any broken strands. Replace worn parts as required with genuine parts.

- Daily: Inspect adapters for damage or excessive wear. Replace as required with genuine parts.
- Monthly: Check equalizer cable tension. Adjust per lift installation instructions. If there are no more threads available for adjustment, replace the cable. Do not use washers to stand off the nut to use previously used threads.
- Monthly: Lubricate the four inside corners of the columns with heavy duty bearing grease.
- Monthly: Lubricate locking latch shafts. Push latch handle several times for oil to penetrate pivot points.
- Every 3 Months: Check anchor bolts for tightness. Anchors should be torqued to 90 ft/lbs.
- Semi-Annually: Check fluid level of lift power unit and refill if required per lift installation instructions.
- Replace all caution, warning or safety related decals on the lift if unable to read or missing.

<b>▲ WARNING</b>	<b>▲ WARNING</b>	<b>▲ CAUTION</b>	<b>▲ CAUTION</b>
<b>Clear area if vehicle is in danger of falling.</b>	<b>Position vehicle with center of gravity midway between adapters.</b>	<b>Lift to be used by trained operator only.</b>	<b>Authorized personnel only in lift area.</b>
<b>▲ WARNING</b>	<b>▲ WARNING</b>	<b>▲ CAUTION</b>	<b>▲ CAUTION</b>
<b>Remain clear of lift when raising or lowering vehicle.</b>	<b>Avoid excessive rocking of vehicle while on lift.</b>	<b>Use vehicle manufacturer's lift points.</b>	<b>Always use safety stands when removing or installing heavy components.</b>
<b>▲ WARNING</b>	<b>▲ WARNING</b>	<b>▲ CAUTION</b>	<b>▲ CAUTION</b>
<b>Do not override self-closing lift controls.</b>	<b>Keep feet clear of lift while lowering.</b>	<b>Use height extenders when necessary to ensure good contact.</b>	<b>Auxiliary adapters may reduce load capacity.</b>
<p>The messages and pictographs shown are generic in nature and are meant to generally represent hazards common to all automotive lifts regardless of specific style.</p> <p>Funding for the development and validation of these labels was provided by the Automotive Lift Institute, PO Box 33116 Indialantic, FL, 32903-3116.</p> <p>They are protected by copyright. Set of labels may be obtained from ALI or its member companies.</p> <p style="text-align: right;">© 1992 by ALI, Inc. ALIWL101w</p>			
<p>The messages and pictographs shown are generic in nature and are meant to generally represent hazards common to all automotive lifts regardless of specific style.</p> <p>Funding for the development and validation of these labels was provided by the Automotive Lift Institute, PO Box 33116 Indialantic, FL, 32903-3116.</p> <p>They are protected by copyright. Set of labels may be obtained from ALI or its member companies.</p> <p style="text-align: right;">© 1992 by ALI, Inc. ALIWL101c</p>			

*INSPECTION and MAINTENANCE*  
See ANSI/ALI ALOIM booklet for periodic inspection checklist and maintenance log sheet.

<b>SAFETY INSTRUCTIONS</b>	<b>SAFETY INSTRUCTIONS</b>
<b>Read operating and safety manuals before using lift.</b>	<b>Proper maintenance and inspection is necessary for safe operation.</b>
<b>SAFETY INSTRUCTIONS</b>	<p>The messages and pictographs shown are generic in nature and are meant to generally represent hazards common to all automotive lifts regardless of specific style.</p> <p>Funding for the development and validation of these labels was provided by the Automotive Lift Institute, PO Box 33116 Indialantic, FL, 32903-3116.</p> <p>They are protected by copyright. Set of labels may be obtained from ALI or its member companies.</p> <p style="text-align: right;">© 1992 by ALI, Inc. ALIWL101s</p>
<b>Do not operate a damaged lift.</b>	



## TROUBLE SHOOTING

<i>Trouble</i>	<i>Cause</i>	<i>Remedy</i>
Motor does not run.	<ol style="list-style-type: none"> <li>1. Blown fuse or circuit breaker.</li> <li>2. Incorrect voltage to motor.</li> <li>3. Bad wiring connections.</li> <li>4. Motor up switch burned out.</li> <li>5. Overhead limit switch burned out.</li> <li>6. Motor windings burned out.</li> </ol>	<ol style="list-style-type: none"> <li>1. Replace blown fuse or reset circuit breaker.</li> <li>2. Supply correct voltage to motor.</li> <li>3. Repair and insulate all connections.</li> <li>4. Replace switch.</li> <li>5. Replace switch.</li> <li>6. Replace motor.</li> </ol>
Motor runs but will not raise lift.	<ol style="list-style-type: none"> <li>1. Open lowering valve.</li> <li>2. Pump sucking air.</li> <li>3. Suction stub off pump.</li> <li>4. Low oil level.</li> </ol>	<ol style="list-style-type: none"> <li>1. Repair or replace lowering valve.</li> <li>2. Tighten all suction line fittings.</li> <li>3. Replace suction stub.</li> <li>4. Fill tank to proper level with ISOVG32 Hydraulic Oil or Dexron III ATF.</li> </ol>
Motor runs—raises unloaded lift but will not raise vehicle.	<ol style="list-style-type: none"> <li>1. Motor running on low voltage.</li> <li>2. Debris in lowering valve.</li> <li>3. Improper relief valve adjustment.</li> <li>4. Overloading lift.</li> </ol>	<ol style="list-style-type: none"> <li>1. Supply correct voltage to motor.</li> <li>2. Clean lowering valve.</li> <li>3. Replace relief valve cartridge.</li> <li>4. Check vehicle weight and/or balance vehicle weight on lift.</li> </ol>
Lift slowly settles down.	<ol style="list-style-type: none"> <li>1. Debris in check valve seat.</li> <li>2. Debris in lowering valve seat.</li> <li>3. External oil leaks.</li> </ol>	<ol style="list-style-type: none"> <li>1. Clean check valve.</li> <li>2. Clean lowering valve.</li> <li>3. Repair external leaks.</li> </ol>
Slow lifting speed or oil blowing out filler breather cap.	<ol style="list-style-type: none"> <li>1. Air mixed with oil.</li> <li>2. Air mixed with oil suction.</li> <li>3. Oil return tube loose.</li> </ol>	<ol style="list-style-type: none"> <li>1. Change oil using ISOVG32 Hydraulic Oil or Dexron III ATF.</li> <li>2. Tighten all suction line fittings.</li> <li>3. Reinstall oil return tube.</li> </ol>
Lift going up unlevel.	<ol style="list-style-type: none"> <li>1. Equalizer cables out of adjustment.</li> <li>2. Lift installed on unlevel floor.</li> </ol>	<ol style="list-style-type: none"> <li>1. Adjust equalizer cables to correct tension.</li> <li>2. Shim lift to level columns (Not to exceed 1/2"). If over 1/2" break out floor and repour per lift installation instructions.</li> </ol>
Anchors will not stay tight.	<ol style="list-style-type: none"> <li>1. Holes drilled oversize.</li> <li>2. Concrete floor thickness or holding strength not sufficient.</li> </ol>	<ol style="list-style-type: none"> <li>1. Relocate lift using a new bit to drill holes. Reference installation instructions for minimum spacing requirements.</li> <li>2. Break out old concrete and repour new pads for lift per lift installation instructions.</li> </ol>
Locking latches do not engage.	<ol style="list-style-type: none"> <li>1. Latch shafts rusted. (Usually occurs on outside installations or in high humidity areas such as vehicle wash bays.)</li> <li>2. Latch spring broken.</li> <li>3. Latch cable needs adjustment.</li> </ol>	<ol style="list-style-type: none"> <li>1. Remove covers, oil latch mechanism. Actuate latch release handle several times to allow oil to coat shaft.</li> <li>2. Replace broken spring.</li> <li>3. Adjust clamp at cable end per lift installation instructions.</li> </ol>
Locking latches do not disengage.	<ol style="list-style-type: none"> <li>1. Latch cable is broken.</li> <li>2. Cable is off sheaves/upper guides.</li> <li>3. Latch cable is loose.</li> </ol>	<ol style="list-style-type: none"> <li>1. Replace cable.</li> <li>2. Check position of cable on sheaves/upper guides; adjust cable tension.</li> <li>3. Adjust cable tension.</li> </ol>
Lift stops short of full rise or chatters.	<ol style="list-style-type: none"> <li>1. Low oil level.</li> <li>2. Air in hydraulic lines/cylinder.</li> </ol>	<ol style="list-style-type: none"> <li>1. Fill tank to proper level with ISOVG32 Hydraulic Oil or Dexron III ATF.</li> <li>2. Bleed lift per installation instructions.*</li> </ol> <p style="text-align: center;">*Lifts with bleeders only.</p>
Lift will not raise off of latches	<ol style="list-style-type: none"> <li>1. Motor, pump, or cylinder failure.</li> </ol>	<ol style="list-style-type: none"> <li>1. Contact lift manufacturer's Customer Service.</li> </ol>



## *Purpose*

This procedure establishes the minimum requirements for the lockout of energy that could cause injury to personnel by the operation of lifts in need of repair or being serviced. All employees shall comply with this procedure.

## *Responsibility*

The responsibility for assuring that this procedure is followed is binding upon all employees and service personnel from outside service companies (i.e., Authorized Lift Installers, contactors, etc.). All employees shall be instructed in the safety significance of the lockout procedure by the facility owner/manager. Each new or transferred employee along with visiting outside service personnel shall be instructed by the owner/manager (or assigned designee) in the purpose and use of the lockout procedure.

## *Preparation*

Employees authorized to perform lockout shall ensure that the appropriate energy isolating device (i.e., circuit breaker, fuse, disconnect, etc.) is identified for the lift being locked out. Other such devices for other equipment may be located in close proximity of the appropriate energy isolating device. If the identity of the device is in question, see the shop supervisor for resolution. Assure that proper authorization is received prior to performing the lockout procedure.

## *Sequence of Lockout Procedure*

- 1) Notify all affected employees that a lockout is being performed and the reason for it.
- 2) Unload the subject lift. Shut it down and assure the disconnect switch is "OFF" if one is provided on the lift.
- 3) The authorized lockout person operates the main energy isolation device removing power to the subject lift.
  - If this is a lockable device, the authorized lockout person places the assigned padlock on the device to prevent its unintentional reactivation. An appropriate tag is applied stating the person's name, at least 3" x 6" in size, an easily noticeable color, and states not to operate device or remove tag.
  - If this device is a non-lockable circuit breaker or fuse, replace with a "dummy" device and tag it appropriately as mentioned above.
- 4) Attempt to operate lift to assure the lockout is working. Be sure to return any switches to the "OFF" position.
- 5) The equipment is now locked out and ready for the required maintenance or service.

## *Restoring Equipment to Service*

- 1) Assure the work on the lift is complete and the area is clear of tools, vehicles, and personnel.
- 2) At this point, the authorized person can remove the lock (or dummy circuit breaker or fuse) & tag and activate the energy isolating device so that the lift may again be placed into operation.

## *Rules for Using Lockout Procedure*

Use the Lockout Procedure whenever the lift is being repaired or serviced, waiting for repair when current operation could cause possible injury to personnel, or for any other situation when unintentional operation could injure personnel. No attempt shall be made to operate the lift when the energy isolating device is locked out.





**Vehicle Service Group<sup>SM</sup>**  
2700 Lanier Drive  
Madison, IN 47250, USA  
1-800-640-5438  
[www.vsgdover.com](http://www.vsgdover.com)



© **Vehicle Service Group<sup>SM</sup>**  
All Rights Reserved. Unless otherwise  
indicated, **Vehicle Service Group<sup>SM</sup>**  
and all other trademarks are property  
of Dover Corporation and its affiliates.