



Wood Working

# OPERATOR'S MANUAL



## MULTI-SPEED BELT DRIVE DRILL PRESS MODEL: DP-4016B

Baileigh Industrial Holdings LLC,  
P.O. Box 531  
Manitowoc, WI 54221-0531  
Phone: 920.684.4990  
Fax: 920.684.3944  
[sales@baileigh.com](mailto:sales@baileigh.com)

REPRODUCTION OF THIS MANUAL IN ANY FORM WITHOUT WRITTEN APPROVAL OF BAILEIGH INDUSTRIAL HOLDINGS LLC, IS PROHIBITED. Baileigh Industrial Holdings LLC, does not assume and hereby disclaims any liability for any damage or loss caused by an omission or error in this Operator's Manual, resulting from accident, negligence, or other occurrence.

# Table of Contents

THANK YOU & WARRANTY .....	1
INTRODUCTION.....	3
GENERAL NOTES.....	3
SAFETY INSTRUCTIONS .....	4
SAFETY PRECAUTIONS .....	6
Dear Valued Customer:.....	6
TECHNICAL SPECIFICATIONS .....	9
TECHNICAL SUPPORT .....	10
UNPACKING AND CHECKING CONTENTS.....	11
Cleaning .....	11
TRANSPORTING AND LIFTING .....	12
INSTALLATION.....	13
Anchoring the Machine.....	14
Securing the Base .....	14
GETTING TO KNOW YOUR MACHINE .....	15
ASSEMBLY AND SET UP .....	17
ELECTRICAL.....	19
ELECTRICAL SCHEMATIC .....	21
OPERATING ADJUSTMENTS.....	22
Belt / Speed Change .....	22
Drill Head and Worktable Adjustment.....	23
Depth Stop.....	24
Drill Protection Guard .....	25
OPERATING PRECAUTIONS .....	26
OPERATION.....	26
Indication of Extreme Speeds and Feeds.....	27
DRILLING RECOMMENDATIONS .....	27
Speeds for Drilling .....	27
Indication of Extreme Speeds and Feeds.....	28
Drill Speed Guide .....	28
LUBRICATION AND MAINTENANCE .....	29
Greasing the Machine .....	30
Storing Machine for Extended Period of Time .....	30
TROUBLESHOOTING .....	31
PARTS DIAGRAM .....	32
Parts List .....	33



## THANK YOU & WARRANTY

Thank you for your purchase of a machine from Baileigh Industrial Holdings LLC. We hope that you find it productive and useful to you for a long time to come.

**Inspection & Acceptance.** Buyer shall inspect all Goods within ten (10) days after receipt thereof. Buyer's payment shall constitute final acceptance of the Goods and shall act as a waiver of the Buyer's rights to inspect or reject the goods unless otherwise agreed. If Buyer rejects any merchandise, Buyer must first obtain a Returned Goods Authorization ("RGA") number before returning any goods to Seller. Goods returned without a RGA will be refused. Seller will not be responsible for any freight costs, damages to goods, or any other costs or liabilities pertaining to goods returned without an RGA. Seller shall have the right to substitute a conforming tender. Buyer will be responsible for all freight costs to and from Buyer and repackaging costs, if any, if Buyer refuses to accept shipment. If Goods are returned in unsalable condition, Buyer shall be responsible for full value of the Goods. Buyer may not return any special-order Goods. Any Goods returned hereunder shall be subject to a restocking fee equal to 30% of the invoice price.

**Specifications.** Seller may, at its option, make changes in the designs, specifications or components of the Goods to improve the safety of such Goods, or if in Seller's judgment, such changes will be beneficial to their operation or use. Buyer may not make any changes in the specifications for the Goods unless Seller approves of such changes in writing, in which event Seller may impose additional charges to implement such changes.

**Limited Warranty.** Seller warrants to the original end-user that the Goods manufactured or provided by Seller under this Agreement shall be free of defects in material or workmanship for a period of twelve (12) months from the date of purchase, provided that the Goods are installed, used, and maintained in accordance with any instruction manual or technical guidelines provided by the Seller or supplied with the Goods, if applicable. The original end-user must give written notice to Seller of any suspected defect in the Goods prior to the expiration of the warranty period. The original end-user must also obtain a RGA from Seller prior to returning any Goods to Seller for warranty service under this paragraph. Seller will not accept any responsibility for Goods returned without a RGA. The original end-user shall be responsible for all costs and expenses associated with returning the Goods to Seller for warranty service. In the event of a defect, Seller, at its sole option, shall repair or replace the defective Goods or refund to the original end-user the purchase price for such defective Goods. Goods are not eligible for replacement or return after a period of 10 days from date of receipt. The foregoing warranty is Seller's sole obligation, and the original end-user's exclusive remedy, with regard to any defective Goods. This limited warranty does not apply to: (a) die sets, tooling, and saw blades; (b) periodic or routine maintenance and setup, (c) repair or replacement of the Goods due to normal wear and tear, (d) defects or damage to the Goods resulting from misuse, abuse, neglect, or accidents, (e) defects or damage to the Goods resulting from improper or unauthorized alterations, modifications, or changes; and (f) any Goods that has not been installed and/or maintained in accordance with the instruction manual or technical guidelines provided by Seller.

**EXCLUSION OF OTHER WARRANTIES.** THE FOREGOING LIMITED WARRANTY IS IN LIEU OF ALL OTHER WARRANTIES, EXPRESS OR IMPLIED. ANY AND ALL OTHER EXPRESS, STATUTORY OR IMPLIED WARRANTIES, INCLUDING BUT NOT LIMITED TO, ANY WARRANTY OF MERCHANTABILITY OR FITNESS FOR ANY PARTICULAR PURPOSE ARE EXPRESSLY DISCLAIMED. NO WARRANTY IS MADE WHICH EXTENDS BEYOND THAT WHICH IS EXPRESSLY CONTAINED HEREIN.

**Limitation of Liability.** IN NO EVENT SHALL SELLER BE LIABLE TO BUYER OR ANY OTHER PARTY FOR ANY INCIDENTAL, CONSEQUENTIAL OR SPECIAL DAMAGES (INCLUDING, WITHOUT LIMITATION, LOST PROFITS OR DOWN TIME) ARISING FROM OR IN MANNER CONNECTED WITH THE GOODS, ANY BREACH BY SELLER OR ITS AGENTS OF THIS AGREEMENT, OR ANY OTHER CAUSE WHATSOEVER, WHETHER BASED ON CONTRACT, TORT OR ANY OTHER THEORY OF LIABILITY. BUYER'S REMEDY WITH RESPECT TO ANY CLAIM ARISING UNDER THIS AGREEMENT IS STRICTLY LIMITED TO NO MORE THAN THE AMOUNT PAID BY THE BUYER FOR THE GOODS.



**Force Majeure.** Seller shall not be responsible for any delay in the delivery of, or failure to deliver, Goods due to causes beyond Seller's reasonable control including, without limitation, acts of God, acts of war or terrorism, enemy actions, hostilities, strikes, labor difficulties, embargoes, non-delivery or late delivery of materials, parts and equipment or transportation delays not caused by the fault of Seller, delays caused by civil authorities, governmental regulations or orders, fire, lightening, natural disasters or any other cause beyond Seller's reasonable control. In the event of any such delay, performance will be postponed by such length of time as may be reasonably necessary to compensate for the delay.

**Installation.** If Buyer purchases any Goods that require installation, Buyer shall, at its expense, make all arrangements and connections necessary to install and operate the Goods. Buyer shall install the Goods in accordance with any Seller instructions and shall indemnify Seller against any and all damages, demands, suits, causes of action, claims and expenses (including actual attorneys' fees and costs) arising directly or indirectly out of Buyer's failure to properly install the Goods.

**Work By Others; Safety Devices.** Unless agreed to in writing by Seller, Seller has no responsibility for labor or work performed by Buyer or others, of any nature, relating to design, manufacture, fabrication, use, installation or provision of Goods. Buyer is solely responsible for furnishing and requiring its employees and customers to use all safety devices, guards and safe operating procedures required by law and/or as set forth in manuals and instruction sheets furnished by Seller. Buyer is responsible for consulting all operator manuals, ANSI or comparable safety standards, OSHA regulations and other sources of safety standards and regulations applicable to the use and operation of the Goods.

**Remedies.** Each of the rights and remedies of Seller under this Agreement is cumulative and in addition to any other or further remedies provided under this Agreement or at law or equity.

**Attorney's Fees.** In the event legal action is necessary to recover monies due from Buyer or to enforce any provision of this Agreement, Buyer shall be liable to Seller for all costs and expenses associated therewith, including Seller's actual attorney fees and costs.

**Governing Law/Venue.** This Agreement shall be construed and governed under the laws of the State of Wisconsin, without application of conflict of law principles. Each party agrees that all actions or proceedings arising out of or in connection with this Agreement shall be commenced, tried, and litigated only in the state courts sitting in Manitowoc County, Wisconsin or the U.S. Federal Court for the Eastern District of Wisconsin. Each party waives any right it may have to assert the doctrine of "forum non conveniens" or to object to venue to the extent that any proceeding is brought in accordance with this section. Each party consents to and waives any objection to the exercise of personal jurisdiction over it by courts described in this section. Each party waives to the fullest extent permitted by applicable law the right to a trial by jury.

**SUMMARY OF RETURN POLICY.**

- 10 Day acceptance period from date of delivery. Damage claims and order discrepancies will not be accepted after this time.
- You must obtain a Baileigh issued RGA number PRIOR to returning any materials.
- Returned materials must be received at Baileigh in new condition and in original packaging.
- Altered items are not eligible for return.
- Buyer is responsible for all shipping charges.
- A 30% re-stocking fee applies to all returns.

Baileigh Industrial Holdings LLC makes every effort to ensure that our posted specifications, images, pricing and product availability are as correct and timely as possible. We apologize for any discrepancies that may occur. Baileigh Industrial Holdings LLC reserves the right to make any and all changes deemed necessary in the course of business including but not limited to pricing, product specifications, quantities, and product availability.

**For Customer Service & Technical Support:**

Please contact one of our knowledgeable Sales and Service team members at: (920) 684-4990 or e-mail us at [sales@baileighindustrial.com](mailto:sales@baileighindustrial.com)



## **INTRODUCTION**

*The quality and reliability of the components assembled on a Baileigh Industrial Holdings LLC machine guarantee near perfect functioning, free from problems, even under the most demanding working conditions. However, if a situation arises, refer to the manual first. If a solution cannot be found, contact the distributor where you purchased our product. Make sure you have the serial number and production year of the machine (stamped on the nameplate). For replacement parts refer to the assembly numbers on the parts list drawings.*

*Our technical staff will do their best to help you get your machine back in working order.*

### **In this manual you will find: (when applicable)**

- Safety procedures
- Correct installation guidelines
- Description of the functional parts of the machine
- Capacity charts
- Setup and start-up instructions
- Machine operation
- Scheduled maintenance
- Parts lists

## **GENERAL NOTES**

After receiving your equipment remove the protective container. Do a complete visual inspection, and if damage is noted, **photograph it for insurance claims** and contact your carrier at once, requesting inspection. Also contact Baileigh Industrial Holdings LLC and inform them of the unexpected occurrence. Temporarily suspend installation.

Take necessary precautions while loading / unloading or moving the machine to avoid any injuries.

Your machine is designed and manufactured to work smoothly and efficiently. Following proper maintenance instructions will help ensure this. Try and use original spare parts, whenever possible, and most importantly; **DO NOT** overload the machine or make any unauthorized modifications.



**Note:** This symbol refers to useful information throughout the manual.





## IMPORTANT

### PLEASE READ THIS OPERATORS MANUAL CAREFULLY

It contains important safety information, instructions, and necessary operating procedures. The continual observance of these procedures will help increase your production and extend the life of the equipment.

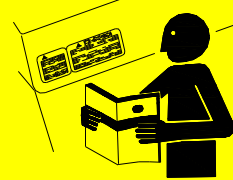

## SAFETY INSTRUCTIONS

### LEARN TO RECOGNIZE SAFETY INFORMATION

This is the safety alert symbol. When you see this symbol on your machine or in this manual, **BE ALERT TO THE POTENTIAL FOR PERSONAL INJURY!**



Follow recommended precautions and safe operating practices.

### UNDERSTAND SIGNAL WORDS

A signal word – **DANGER**, **WARNING**, or **CAUTION** – is used with the safety alert symbol. **NOTICE**, which is not related to personal injury, is used without a symbol.

**DANGER:** Indicates a hazardous situation which, if not avoided, will result in death or serious injury.

**WARNING:** Indicates a hazardous situation which, if not avoided, could result in death or serious injury.

**CAUTION:** Indicates a hazardous situation which, if not avoided, could result in minor or moderate injury.

**NOTICE:** Indicates a situation which, if not avoided, could result in property damage.

**DANGER**

**WARNING**

**CAUTION**

**NOTICE**



**SAVE THESE INSTRUCTIONS.**  
**Refer to them often and use them to instruct others.**



**PROTECT EYES**

Wear safety glasses or suitable eye protection when working on or around machinery.

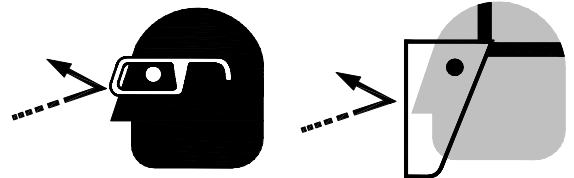

**PROTECT AGAINST NOISE**

Prolonged exposure to loud noise can cause impairment or loss of hearing. Wear suitable hearing protective devices such as ear muffs or earplugs to protect against objectionable or uncomfortable loud noises.

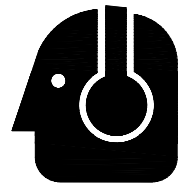

**BEWARE OF PIERCING POINTS AND CUTTING HAZARD**

**NEVER** place hands, fingers, or any part of your body on or near rotating tooling. This tooling can be extremely dangerous if you do not follow proper safety procedures. **Keep hand at least 6 inches (150mm) from the tooling while operating.**

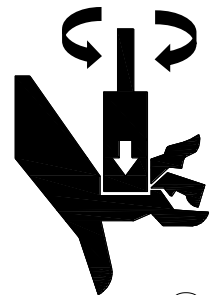

**ENTANGLEMENT HAZARD – ROTATING SPINDLE**

Contain long hair, **DO NOT** wear jewelry or loose-fitting clothing.



**EMERGENCY STOP BUTTON**

In the event of incorrect operation or dangerous conditions, the machine can be stopped immediately by pressing the **E-STOP** button. Twist the emergency stop button clockwise (cw) to reset. Note: Resetting the E-Stop will not start the machine.





### TIP OVER HAZARD

**THIS MACHINE MUST BE ANCHORED TO THE BENCH.** To prevent possible tip over from unbalanced operation, properly anchor this machine to a suitable bench surface. If not familiar with such anchoring, consult a machinery rigging company trained and familiar with such installations and operations.



### CALIFORNIA PROPOSITION 65

WARNING: Cancer and Reproductive Harm.  
[www.P65Warnings.ca.gov](http://www.P65Warnings.ca.gov)



## SAFETY PRECAUTIONS



Wood working can be dangerous if safe and proper operating procedures are not followed. As with all machinery, there are certain hazards involved with the operation of the product. Using the machine with respect and caution will considerably lessen the possibility of personal injury. However, if normal safety precautions are overlooked or ignored, personal injury to the operator may result.

Safety equipment such as guards, push sticks, hold-downs, feather boards, goggles, dust masks and hearing protection can reduce your potential for injury. But even the best guard will not make up for poor judgment, carelessness or inattention. **Always use common sense** and exercise **caution** in the workshop. If a procedure feels dangerous, don't try it.

**REMEMBER: Your personal safety is your responsibility.**



**WARNING: FAILURE TO FOLLOW THESE RULES MAY RESULT IN SERIOUS PERSONAL INJURY**

### **Dear Valued Customer:**

- All Baileigh woodworking machines should be used only for their intended use.
- Baileigh does not recommend or endorse making any modifications or alterations to a Baileigh machine. Modifications or alterations to a machine may pose a substantial risk of injury to the operator or others and may do substantial damage to the machine.
- Any modifications or alterations to a Baileigh machine will invalidate the machine's warranty.

**Please enjoy your Baileigh machine! ....Please enjoy it SAFELY!**





1. **FOR YOUR OWN SAFETY, READ INSTRUCTION MANUAL BEFORE OPERATING THE MACHINE.** Learn the machine's application and limitations as well as the specific hazards.
2. **Only trained and qualified personnel can operate this machine.**
3. **Make sure guards are in place and in proper working order before operating machinery.**
4. **Remove any adjusting tools.** Before operating the machine, make sure any adjusting tools have been removed.
5. **Keep work area clean.** Cluttered areas invite injuries.
6. **Overloading machine.** By overloading the machine, you may cause injury from flying parts. **DO NOT** exceed the specified machine capacities.
7. **Do not force tool.** Your machine will do a better and safer job if used as intended. **DO NOT** use inappropriate attachments in an attempt to exceed the machines rated capacity.
8. **Use the right tool for the job. DO NOT** attempt to force a small tool or attachment to do the work of a large industrial tool. **DO NOT** use a tool for a purpose for which it was not intended.
9. **Dress appropriately. DO NOT** wear loose fitting clothing or jewelry as they can be caught in moving machine parts. Protective clothing and steel toe shoes are recommended when using machinery. Wear a restrictive hair covering to contain long hair.
10. **Use eye protection.** Always wear ISO approved protective eye wear when operating machinery. Wear a full-face shield if you are producing metal filings. Eye wear shall be impact resistant, protective safety glasses with side shields which comply with ANSI Z87.1 specification. Use of eye wear which does not comply with ANSI Z87.1 specification could result in severe injury from breakage of eye protection.
11. **Do not overreach.** Maintain proper footing and balance at all times. **DO NOT** reach over or across a running machine.
12. **Stay alert.** Watch what you are doing and use common sense. **DO NOT** operate any tool or machine when you are tired.
13. **Check for damaged parts.** Before using any tool or machine, carefully check any part that appears damaged. Check for alignment and binding of moving parts that may affect proper machine operation.
14. **Observe work area conditions. DO NOT** use machines or power tools in damp or wet locations. Do not expose to rain. Keep work area well lighted. **DO NOT** use electrically powered tools in the presence of flammable gases or liquids.
15. **DO NOT operate machine if under the influence of alcohol or drugs.** Read warning labels on prescriptions. If there is any doubt, **DO NOT** operate the machine.
16. **DO NOT** touch live electrical components or parts.



17. Be sure all equipment is properly installed and grounded according to national, state, and local codes.
18. Keep all cords dry and free from grease and oil.
19. Inspect power and control cables periodically. Replace if damaged or bare wires are exposed. **Bare wiring can kill!**
20. Keep visitors a safe distance from the work area.
21. **Keep children away.** Children must never be allowed in the work area. **DO NOT** let them handle machines, tools, or extension cords.
22. **Store idle equipment.** When not in use, tools must be stored in a dry location to inhibit rust. Always lock up tools and keep them out of reach of children.
23. Turn off power before checking, cleaning, or replacing drill bits, or making adjustments or servicing the machine.
24. Turn off main power to the machine and wait for the drill bit to stop turning before removing debris, removing or securing the piece part, or changing the position of the worktable.
25. Never expose your hands or limbs to the cutting area while the machine is operating.
26. Make sure it is possible to move freely around the machine and associated equipment. The floor should be kept clean and dry, and the surrounding area well illuminated, so that work can be performed safely.
27. **Properly** lock the drill bit in the chuck before operating the machine.
28. **Hold** the piece part firmly against the table. **DO NOT** attempt to drill a piece part that does not have a flat surface against the table, or that is not secured by a vise. Prevent the piece part from rotating by clamping it to the table or by securing it against the drill press column.
29. Never leave the machine running while unattended. Turn the power OFF. Do not leave the machine until the spindle comes to a complete stop. **When the machine** is **NOT** in use, the drill bit should **NOT** be rotating.
30. Remove adjusting keys and wrenches before turning drill press on. Never start the machine before clearing the table of all objects (tools, scrap pieces, etc.)
31. **DO NOT** bypass or defeat any safety interlock systems. Never use the drill press without the swing-away safety guard. Use the safety guard. The safety guard prevents chips from flying out and causing cuts or burns.



## **TECHNICAL SPECIFICATIONS**

Drilling Capacity	0.787" (20mm)
Chuck	B16, 0.039" – 0.625" (1 – 16mm)
Spindle Travel	3.93" (100mm)
Spindle Taper	MT2
Quill Diameter	2.04" (52mm)
Swing	16.14" (410mm)
Min. Distance Spindle to Table	0" (0mm)
Max. Distance Spindle to Table	13.18" (335mm)
Max. Distance Spindle to Base	22.83" (580mm)
Head Travel	13" (330mm)
Table Travel	8.66" (220mm)
Table Tilt	±45°
Table Rotation	360°
Work Table Area	11.14" x 9.76" (283 x 248mm)
Work Table Slots	2 @ .531" x 5.90" x 5.1" OC (13.5 x 150mm x 130mm OC)
Column Diameter/Material	Ø2.75" (Ø70mm) / Cast Iron
Number of Spindle Speeds	5
Pulleys Materials	Cast Iron
Range of Spindle Speeds	250 – 2900RPM
Power Transmission	Micro Poly-V Belt
Base Work Area	10.63" x 10.03" (270 x 255mm)
Base T-Slots	2 @ .531" x 10.63" x 5.51" OC (13.5 x 270mm x 140mm OC)
Base Dimensions	20.47" x 13.58" (520 x 345mm)
Assembled Dimensions	29.13" x 17.52" x 41.33" (740 x 445 x 1040mm)
Table/Base Material	Cast Iron
Head Stock Material	Cast Iron
Power Supply	115V 60hz
Motor	.5hp (.37kw) 115V / 60hz / 5.6A
Net Weight	205lbs (93kgs)
Shipping Weight	269lbs (122kgs)
Shipping Dimensions	48" x 30" x 21" (1219 x 762 x 534mm)
Based on a material tensile strength of *64000 PSI – mild steel	



## TECHNICAL SUPPORT

Our technical support department can be reached at 920.684.4990 and asking for the support desk for purchased machines. Tech Support handles questions on machine setup, schematics, warranty issues, and individual parts needs: (other than die sets and blades).

For specific application needs or future machine purchases contact the Sales Department at: [sales@baileigh.com](mailto:sales@baileigh.com), Phone: 920.684.4990, or Fax: 920.684.3944.



**Note:** *The photos and illustrations used in this manual are representative only and may not depict the actual color, labeling or accessories and may be intended to illustrate technique only.*



**Note:** *The specifications and dimensions presented here are subject to change without prior notice due to improvements of our products.*



## UNPACKING AND CHECKING CONTENTS

Your Baileigh machine is shipped complete. Separate all parts from the packing material and check each item carefully. Make certain all items are accounted for before discarding any packing material.

**⚠ WARNING: SUFFOCATION HAZARD!** Immediately discard any plastic bags and packing materials to eliminate choking and suffocation hazards to children and animals.

If any parts are missing, **DO NOT** place the machine into service until the missing parts are obtained and installed correctly.

### Cleaning

**⚠ WARNING: DO NOT USE** gasoline or other petroleum products to clean the machine. They have low flash points and can explode or cause fire.

**⚠ CAUTION:** When using cleaning solvents work in a well-ventilated area. Many cleaning solvents are toxic if inhaled.

Your machine may be shipped with a rustproof waxy coating and/or grease on the exposed unpainted metal surfaces. Fully and completely remove this protective coating using a degreaser or solvent cleaner. Moving items will need to be moved along their travel path to allow for cleaning the entire surface. For a more thorough cleaning, some parts will occasionally have to be removed. **DO NOT USE** acetone or brake cleaner as they may damage painted surfaces.

Follow manufacturer's label instructions when using any type of cleaning product. After cleaning, wipe unpainted metal surfaces with a light coating of quality oil or grease for protection.



**Important:** This waxy coating is **NOT** a lubricant and will cause the machine to stick and lose performance as the coating continues to dry.





## **TRANSPORTING AND LIFTING**

**NOTICE:** *Lifting and carrying operations should be carried out by skilled workers, such as a truck operator, crane operator, etc. If a crane is used to lift the machine, attach the lifting chain carefully, making sure the machine is well balanced.*

### **Follow these guidelines when lifting with truck or trolley:**

- The lift truck must be able to lift at least 1.5 – 2 times the machines gross weight.
- Make sure the machine is balanced. While transporting, avoid rough or jerky motion, and maintain a safe clearance zone around the transport area.
- Use a fork lift with sufficient lifting capacity and forks that are long enough to reach the complete width of the machine.
- Remove the securing bolts that attach the machine to the pallet.
- Approaching the machine from the side, lift the machine on the frame taking care that there are no cables or pipes in the area of the forks.
- Move the machine to the required position and lower gently to the floor.
- Level the machine so that all the supporting feet are taking the weight of the machine and no rocking is taking place.

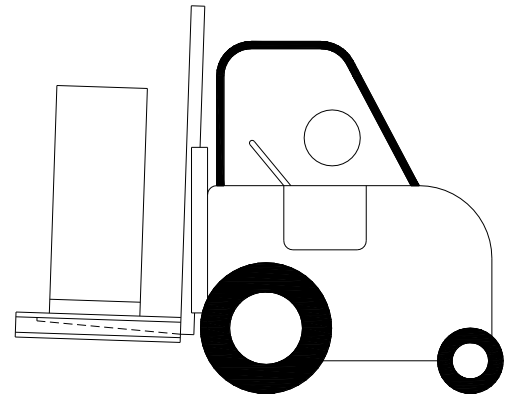

### **Follow these guidelines when lifting crane or hoist:**

- Always lift and carry the machine with the lifting holes provided at the top of the machine.
- Use lift equipment such as straps, chains, capable of lifting 1.5 to 2 times the weight of the machine.
- Take proper precautions for handling and lifting.
- Check if the load is properly balanced by lifting it an inch or two.
- Lift the machine, avoiding sudden accelerations or quick changes of direction.
- Locate the machine where it is to be installed, then lower slowly until it touches the floor.





## INSTALLATION

### **IMPORTANT:**

Consider the following when looking for a suitable location to place the machine:

- Overall weight of the machine.
- Weight of material being processed.
- Sizes of material to be processed through the machine.
- Space needed for auxiliary stands, work tables, or other machinery.
- Clearance from walls and other obstacles.
- Maintain an adequate working area around the machine for safety.
- Have the work area well illuminated with proper lighting.
- Keep the floor free of oil and make sure it is not slippery.
- Remove scrap and waste materials regularly, and make sure the work area is free from obstructing objects.
- If long lengths of material are to be fed into the machine, make sure that they will not extend into any aisles.
- **LEVELING:** The machine should be sited on a level, concrete floor. Provisions for securing it should be in position prior to placing the machine. The accuracy of any machine depends on the precise placement of it to the mounting surface.
- **FLOOR:** This machine distributes a large amount of weight over a small area. Make certain that the floor is capable of supporting the weight of the machine, work stock, and the operator. The floor should also be a level surface. If the unit wobbles or rocks once in place, be sure to eliminate by using shims.
- **WORKING CLEARANCES:** Take into consideration the size of the material to be processed. Make sure that you allow enough space for you to operate the machine freely.
- **POWER SUPPLY PLACEMENT:** The power supply should be located close enough to the machine so that the power cord is not in an area where it would cause a tripping hazard. Be sure to observe all electrical codes if installing new circuits and/or outlets.



## Anchoring the Machine

**⚠ WARNING:** Before operating the Baileigh Drill Press make sure it is securely bolted to a bench which is in turn secured to the floor to prevent tip over. If the drill press tips over on you, it could cause severe injury or death.

- Sizes of material to be processed through the machine.
- Space needed for auxiliary stands, worktables, or other machinery.
- Clearance from walls and other obstacles on each side of the machine to allow for head and or table swing.
- Maintain an adequate working area around the machine for safety.
- Have the work area well illuminated with proper lighting.
- Remove scrap and waste materials regularly, and make sure the work area is free from obstructing objects.
- Keep the floor free of oil and make sure it is not slippery.
- Once positioned, mount the machine on a workbench being aware of the following:
  - Overall weight of the machine and the weight of material being processed.
  - Make sure the workbench is properly reinforced to support the total weight.
  - The strongest mounting option is where the holes are drilled all the way through the workbench and the machine is secured with bolts, washers, and nuts.



Two Person Lift. Use an assistant or lifting devise to support the weight of the machine.

## Securing the Base

- The base of the drill press has two mounting holes. The drill press should be level and rest solidly on the bench. Place shims under the four corners of the base as required for leveling the drill press.
- Locate the drill press on your work surface.
- Using the base as a template, mark the holes on the mounting surface.
- Drill thru and bolt down the base. Customer to provide necessary hardware.



## GETTING TO KNOW YOUR MACHINE

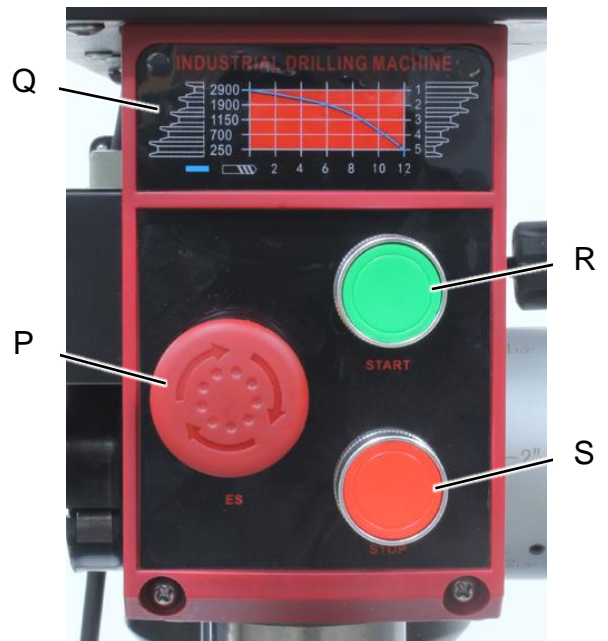
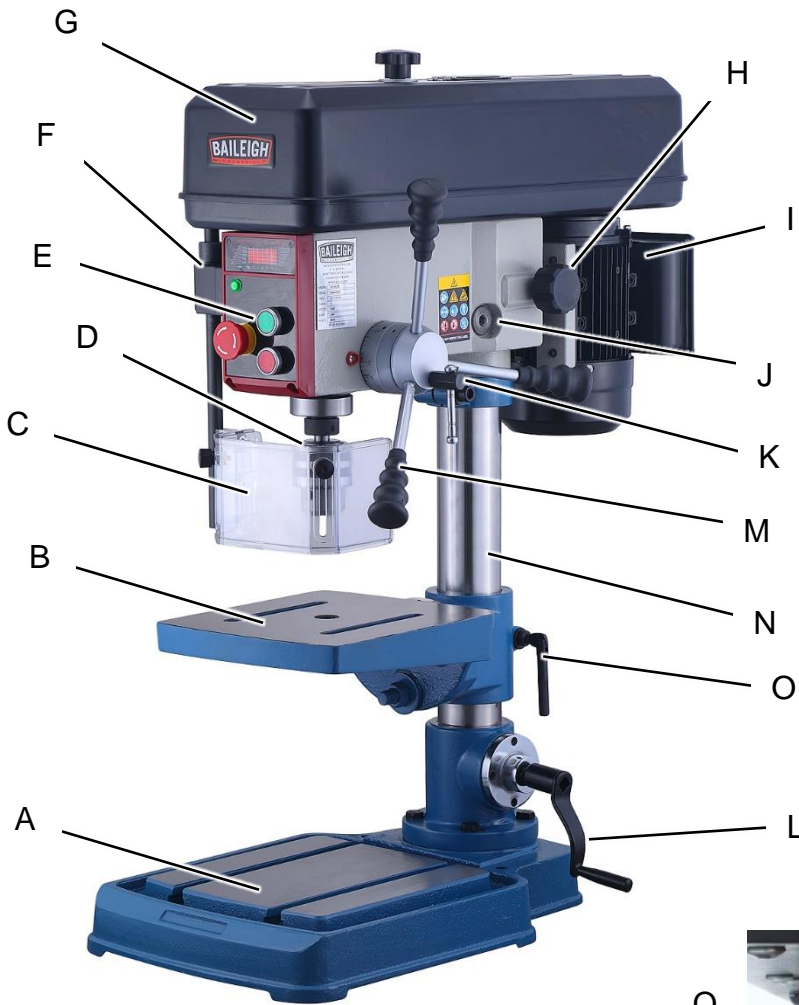



Item	Description
A	Base with work surface and T-slots.
B	Worktable with T-slots.
C	Chuck Guard with safety interlock.
D	Chuck.
E	Operator Controls
F	Safety interlock switch for the Chuck Guard.
G	Removable Drive Cover. Provides access to the sheave to change the spindle speed.
H	Belt tension lock knobs. Two, one on each side.
I	Drive Motor.
J	Head to Column Clamping Bolt. Allows head to pivot on the Column. <b>⚠ WARNING: Before operating the Baileigh Drill Press make sure it is firmly secured to a bench. If it tips over on you, it could cause severe injury or death.</b>
K	Depth Stop Lock Knob.
L	Table Elevation (Lift/Lower) Handle.
M	Quill Feed Handle.
N	Column.
O	Table Elevation Lock Handle.
P	Emergency Stop Button (Estop). In the event of incorrect operation or dangerous conditions, the machine can be stopped immediately by pressing the <b>E-STOP</b> button. Twist the emergency stop button clockwise (cw) to reset. Note: Resetting the E-Stop will not start the machine.
Q	Spindle Speed Chart. Use the chart as a guide for setting the spindle rpm for a drilling operation. Note: This chart is a guide. Specific results will vary. Consult the drill manufacturer for more detailed drilling information.
R	Green Start Button. Verify that the spindle and chuck are clear, the bit is secure and held firm. Press to the motor and thus spindle rotation.
S	Red Stop Button. Press to stop the motor and spindle.



## ASSEMBLY AND SET UP

**⚠ WARNING:** For your own safety, **DO NOT** connect the machine to the power source until the machine is completely assembled and you read and understand the entire instruction manual.



*Two Person Lift. A lifting device will be needed, and an assistant is highly recommended. Use an assistant or lifting device (recommended) to support the weight of the drill head during assembly.*

1. Open the carton and inspect the contents.
2. Lift the base, column, and table assembly out of the carton and position where the drill is intended to be placed.
3. Use the mounting holes as a template and mark the location on the bench for the anchor bolts.
4. Install the anchor bolts (customer supplied) and secure the base, column, and table assembly to the bench with the anchor bolts.
5. Check that the stop collar (A) is secure to the column.
6. Using an appropriate lifting device, carefully lift the head assembly out of the carton and over the column.
7. Insert the column into the pocket on the bottom of the head assembly until the column is fully seated into the head pocket.
8. Install the slip wedge pin and clamping bolt assembly into the casting with the taper (B) toward the column. (Taper shown up for visibility.)
9. Install the treaded wedge pin in from the opposite side and lightly tighten the clamping bolt.

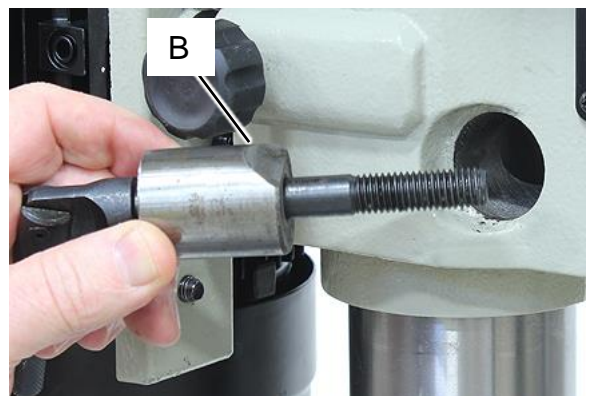
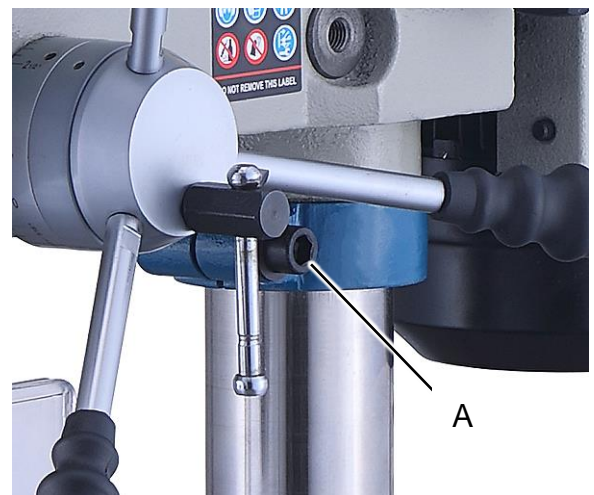





**⚠ CAUTION:** Before operating the drill each day, verify that the head is secured to the column. Failure to ensure that the head is secure to the column may allow the head to twist unexpectedly during operation causing damage and or injury.

10. Position the headstock directly over the base by using a plumb bob and measuring tape or ruler across the drill press base to find its center.
11. Suspend the plumb line from the center of the headstock and lower the bob until it is near the tape/ruler as shown.
12. Rotate the headstock from side to side until the tip is equidistant from both the left and right sides.
13. Tighten the wedge clamping bolt to secure headstock to the column.
14. Install the three handles into the handle hub.
15. Install the chuck guard assembly into the holder.
16. Remove the cap screw and washer (C) and insert the guard shaft into the holder from the bottom up.
17. Install the height adjustment bushing onto the top of the shaft and align the lock screw (D) with the groove in the shaft.
18. Tighten the lock screw (D) just enough to hold the shaft at the desired height.
19. Install the flat washer and cap screw (C) into the top of the shaft and securely tighten.
20. Verify that the detent ball engages into the groove on the shaft when the chuck guard is closed and covering the chuck area.
21. Install the chuck onto the spindle.
22. Clean and dry the spindle shaft and the chuck bore.
23. Adjust the chuck so that the jaws are retracted into the chuck body.
24. Using a soft mallet, tap the chuck firmly up onto the spindle shaft.

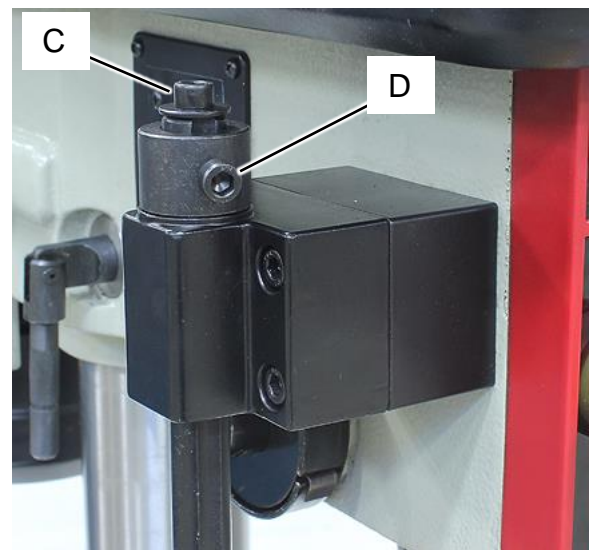
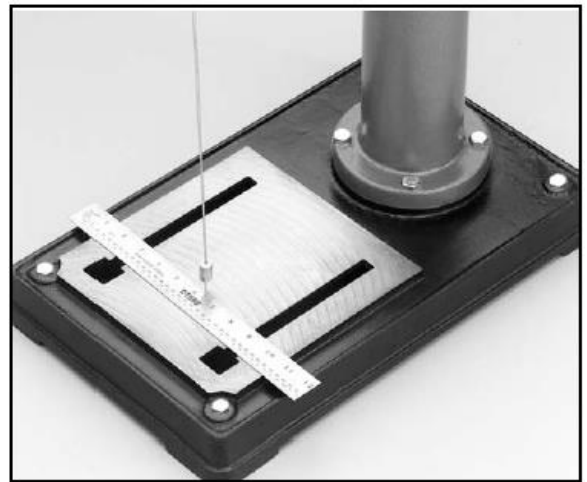





## ELECTRICAL

 **CAUTION:** HAVE ELECTRICAL UTILITIES CONNECTED TO MACHINE BY A CERTIFIED ELECTRICIAN!  
Check if the available power supply is the same as listed on the machine nameplate.

 **WARNING:** Make sure the grounding wire (green) is properly connected to avoid electric shock. DO NOT switch the position of the green grounding wire if any electrical plug wires are switched during hookup.

### Power Specifications

Your machine is wired for 115 volts, 60hz alternating current. Before connecting the machine to the power source, make sure the power source is OFF.

Before switching on the power, you must check the voltage and frequency of the power to see if they meet with the requirement, the allowed range for the voltage is  $\pm 5\%$ , and for the frequency is  $\pm 1\%$ .

### Considerations

- Observe local electrical codes when connecting the machine.
- The circuit should be protected with a time delay fuse or circuit breaker with an amperage rating slightly higher than the full load current of machine.
- A separate electrical circuit should be used for your machines. Before connecting the motor to the power line, make sure the switch is in the "OFF" position and be sure that the electric current is of the same characteristics as indicated on the machine.
- All line connections should make good contact. Running on low voltage will damage the motor.
- In the event of a malfunction or breakdown, grounding provides a path of least resistance for electric current to reduce the risk of electric shock. This machine is equipped with an electric cord having an equipment-grounding conductor and a grounding plug. The plug must be plugged into a matching outlet that is properly installed and grounded in accordance with all local codes and ordinances.

 **WARNING:** In all cases, make certain the receptacle in question is properly grounded. If you are not sure, have a qualified electrician check the receptacle.



- Improper connection of the equipment-grounding conductor can result in risk of electric shock. The conductor with insulation having an outer surface that is green with or without yellow stripes is the equipment-grounding conductor. If repair or replacement of the electric cord or plug is necessary, do not connect the equipment-grounding conductor to a live terminal.
- Check with a qualified electrician or service personnel if the grounding instructions are not completely understood, or if in doubt as to whether the machine is properly grounded.
- Repair or replace damaged or worn cord immediately.

**Extension Cord Safety**

Extension cord should be in good condition and meet the minimum wire gauge requirements listed below:

AMP RATING	LENGTH		
	25ft	50ft	100ft
1-12	16	16	14
13-16	14	12	12
17-20	12	12	10
21-30	10	10	No
WIRE GAUGE			

An undersized cord decreases line voltage, causing loss of power and overheating. All cords should use a ground wire and plug pin. Replace any damaged cords immediately.

**Power cord connection:**

1. Unwrap the power cord and route the cord away from the machine toward the power supply.
  - a. Route the power cord so that it will NOT become entangled in the machine in any way.
  - b. Route the cord to the power supply in a way that does NOT create a trip hazard.
2. Connect the power cord to the power supply and check that the power cord has not been damaged during installation.
3. When the machine is clear of any obstruction. The main power switch may be turn ON to test the operation. Turn the switch OFF when the machine is not in operation.



## ELECTRICAL SCHEMATIC

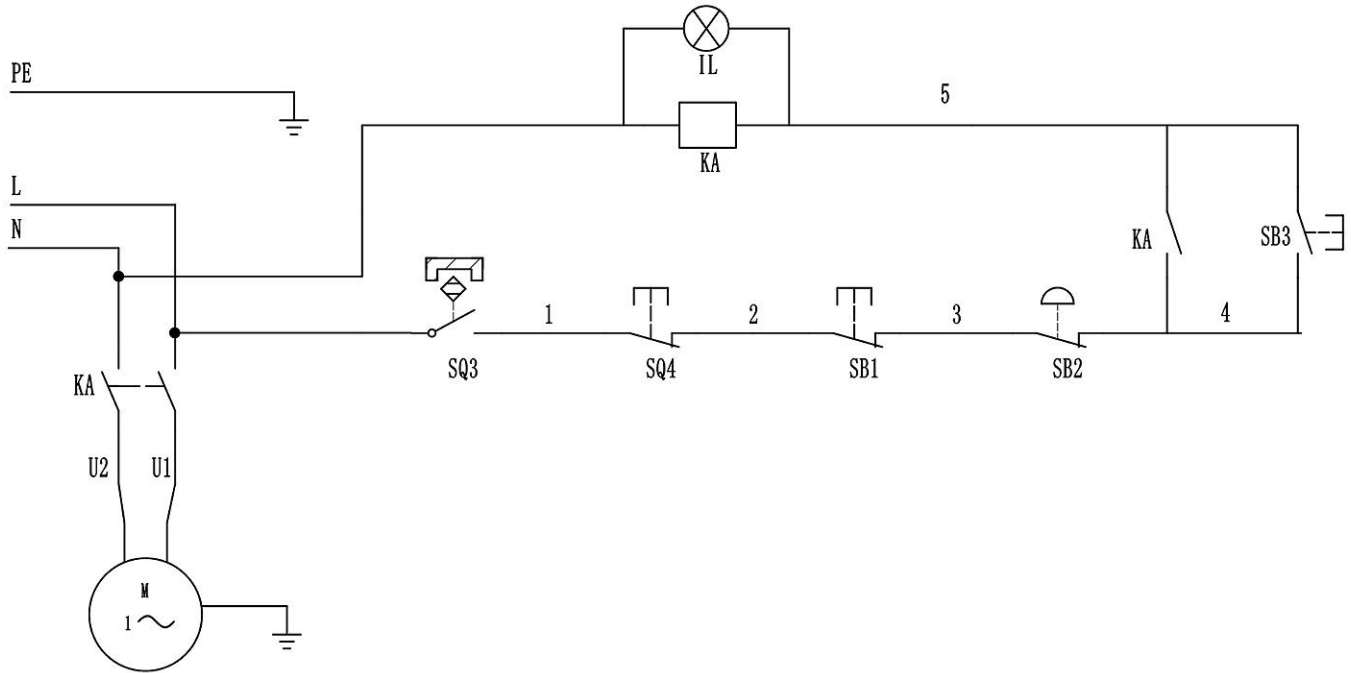

### Electrical Parts List

Item	Description	Type	Specification
SQ3	Belt Break Proximity Switch	LJC1-3/24, CHIIB	1.2W, 50mA
SQ4	Chuck Shield Micro Switch	KW7, LEMA, CE	125/250V 8A
SB3	Start Switch	LA115-A5-10BN, GQELE, CE	Ui:600V, Ith:10A
SB1	Stop Switch	LA115-A5-01BN, GQELE, CE	Ui:600V, Ith:10A
SB2	Emergency Stop Switch	LA115-A5-01ZS, GQELE, CE	Ui:600V, Ith:10A
KA	Motor Run Relay	DZ07B, DKLD	Ui:400V, Uc:110~120V
IL	Indicator Lamp	Ø10mm, 110VAC	



## OPERATING ADJUSTMENTS

### Belt / Speed Change

1. Disconnect the drill from the power supply.
2. Remove the lock knob and washer from the top of the belt cover.
3. Remove the belt cover
4. Use the chart on the face of the control panel to determine the rpm desired.
5. Loosen the tension jack bolts (A) one turn each.
6. Loosen the tension lock knobs (B, one on each side of head) and allow the motor to slide slightly closer to the spindle. This will loosen the belt enough to allow it to be moved to another set of pulleys.
7. Rotate the pulleys by hand and carefully work the belt off the larger (depending upon the current speed setting this may be either the spindle or the motor pulley) of the pulleys onto a smaller pulley to remove additional belt tension.
8. Position the belt on smaller of the pulleys to be used for the new speed and then rotate the pulleys by hand and work the other end of the belt onto the matching pulley.
9. Tighten each of the tension jack bolts (A) one turn to place the tension back onto the belt.
10. Tighten the tension lock knobs (B) to hold the motor in position.

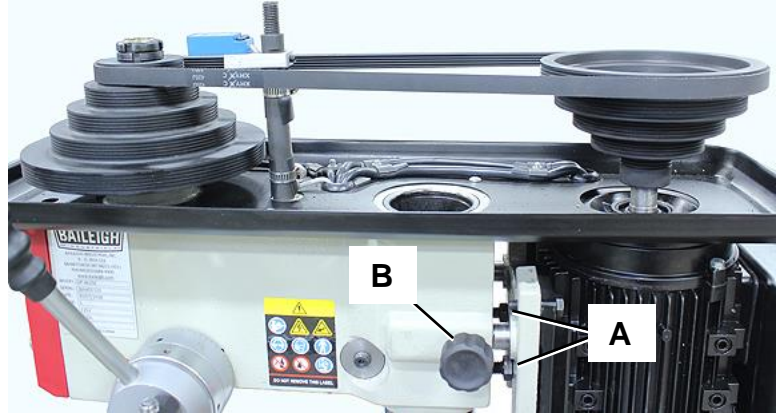

**Note:** Belt tension should be loose enough to allow 5-10mm movement when pushing the belt from the side.

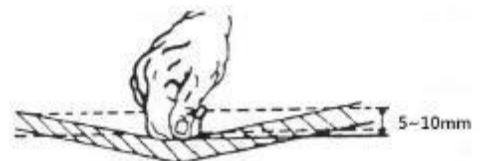

**IMPORTANT:** The drive belt is a multi-groove V-belt. The belt must run true and straight across an even set of sheaves. Do not allow the belt to run at an angle between the sheaves. Do not allow even part of the belt to be above or below the sheaves.

11. Install and secure the belt cover using the flat washer and lock knob removed at the start of the procedure.





## Drill Head and Worktable Adjustment

This drill press design allows for the head and the worktable to be adjusted and rotated as needed to provide for a wide variety of drilling options.

**NOTICE:** Use care to maintain load balance when rotating the head and/or the table. When applying downward pressure during the drilling process, a poorly secured work piece may come loose and fall or rotate causing material or equipment damage.

### Drill Head Adjustment

The drill head may be adjusted up and down and for rotation.



**Note:** Always use an assistant or lifting device to help raise or lower the drill head. Do not allow the power cord to interfere with the drill spindle in any way.

### Elevation

1. Loosen the socket head screw (A) on the retaining ring.
2. Loosen the head to column clamping bolt (B, located on the opposite side).

**⚠ WARNING:** Failure to lock the head bolt can result in damage of the machine and personal injury.

3. Raise or lower the head to the desired height.
4. Tighten the head to column clamping bolt (B).
5. Slide the retaining ring up tight to the bottom of the drill head and securely tighten the socket head screw (A).
6. Carefully release the column clamping bolt (B) to remove any gap between the retaining ring and the head. Tighten the column clamping bolt.

### Rotation

1. Set the head elevation.
2. Loosen the head to column clamping bolt (B, located on the opposite side).
3. Rotate the head as desired.
4. Tighten the head to column clamping bolt (B).

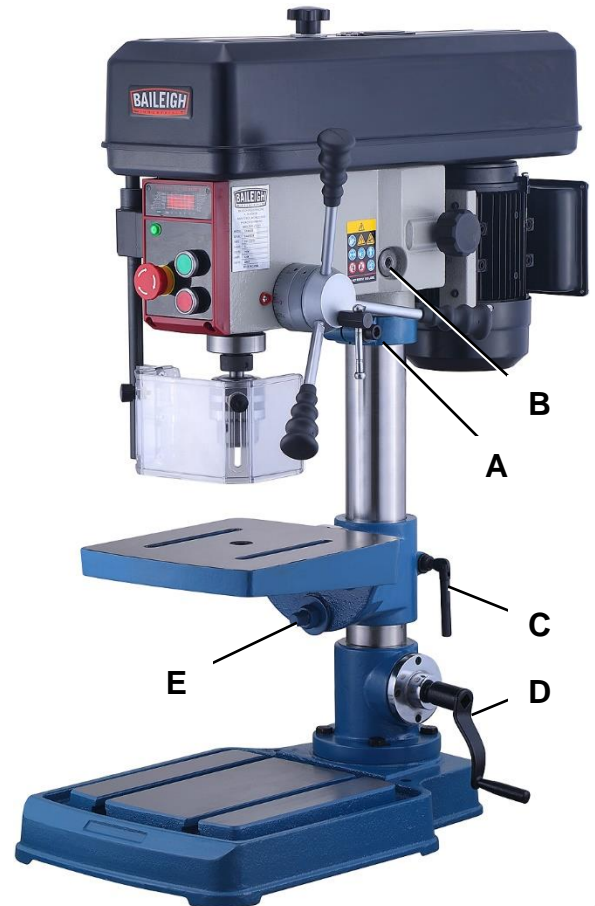





## Worktable Adjustment

The worktable may be adjusted for elevation and tilting.



**Note:** Always remove all material, tools and vises before adjusting the worktable.

### **Elevation and Rotation**

1. Support the worktable and loosen the clamping bolt (C).
2. Use the crank handle (D) to lift or lower the table as desired.
3. Hold the table in position and tighten the clamping bolt (C).

### **Tilt**

1. Support the worktable and loosen the tilting nut (E).
2. Use the scale at the back of the table as an indicator of the degree of tilt.
3. When the table is at the desired tilt angle, hold in position and tighten the nut (E).

## Depth Stop

This drill press comes with a depth stop adjustment for use when drilling.

1. Loosen the depth collar lock knob (A).
2. Secure the material you will be drilling onto the drill press table.
3. With the desired bit installed, lower the spindle until the tip of the bit just touches the material you will be drilling. Hold the spindle in this position.
4. Turn the depth collar to the desired depth indicated by the scale on the collar (B).
5. Secure the collar by tightening the lock knob (A).
6. Remove the material and test the depth stop by measuring how far the spindle travels when the handles are rotated.

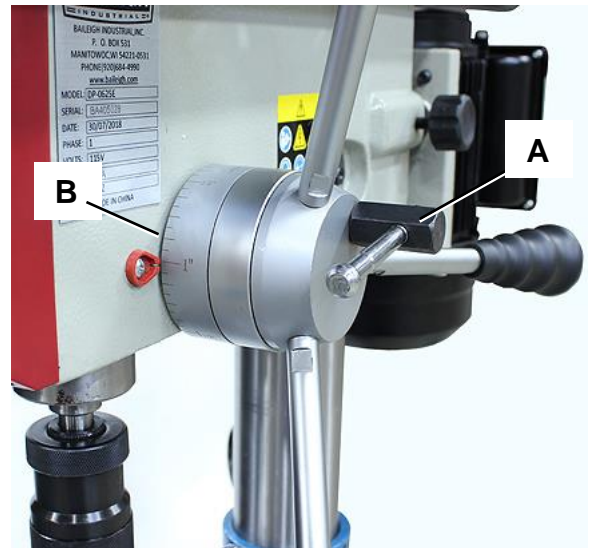





## Drill Protection Guard

The machine is provided with a security drill guard. Before pressing the starting push button, set the drill guard in the working position, otherwise the machine controls will not start.



**Important:** If the guard is opened when operating the machine, the machine will stop. **DO NOT REMOVE THE GUARD UNDER ANY CIRCUMSTANCES.**

The drill guard can be adjusted for height and position.

1. Loosen the two thumb knobs (A) to increase or decrease the height of the drill guard.
2. Slide the lower half of the guard up or down within the slots to set the height.
3. Tighten the thumb knobs to hold the lower guard in position.
4. The drill guard can slide up within the mounting bracket with the stop block (B) stopping the downward travel. (Drill guard shown fully lowered.)
5. The stop block (B) can be set at different positions by loosening the lock bolt (B also), sliding the guard and shaft assembly upward, and then tightening the lock bolt to hold the guard at that position.

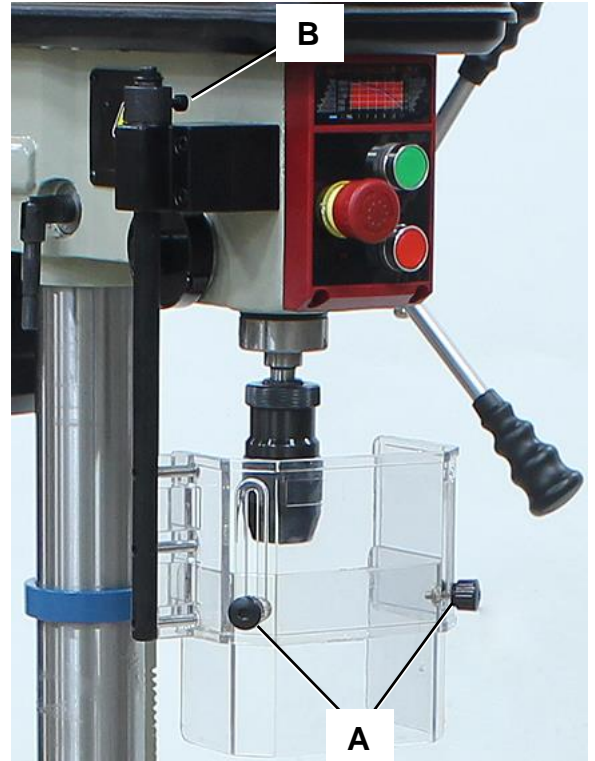



## OPERATING PRECAUTIONS

The following operating and safety precautions must be observed in order to avoid harm to the operator or damage to the drill press.

1. Safety is the responsibility of the user/purchaser since conditions differ between jobs. Use and enforce safety procedures at each operation location and provide for any changes in conditions to provide maximum safety.
2. The head assembly must be locked to the column, so the thrust produced by drilling will not force the head assembly up the column.
3. The worktable must be locked to the column so it will not be forced down the column.
4. DO NOT start to drill the workpiece until making certain the workpiece is held down securely. Secure clamping and vises are preferred.
5. Make sure the drill is secured in the spindle or check before attempting to use the drill press.
6. Make sure the spindle taper is clean and free of burrs, scoring, and galling to assure maximum gripping.

## OPERATION



**CAUTION:** Always wear proper eye protection with side shields, safety footwear, and leather gloves to protect from burrs and sharp edges. When handling large heavy material make sure they are properly supported.

1. Secure drill bit in the chuck. Insert the drill into the chuck jaws at least 1" (25.4mm) when possible but do not insert it so far that the jaws touch the flutes of the drill. Verify that the drill is centered in the chuck and tighten securely with the chuck key.
2. Set the table to the desired height and verify it is securely locked. Allow for any clamps or vises. Adjust the safety guard as necessary.
3. Set the depth stop as needed.
4. Load and secure the piece part to the table. If not using a clamping devise, position the material against the left side of the column to prevent the material from spinning during the drilling process.
5. Verify that the chuck is clear of any entanglements and start the drill.
6. Selects the appropriate spindle speed for the workpiece and drill bit.
7. Wears safety glasses or a face shield.
8. Starts the machine.



9. Use the feed handle to feed the drill into the material. Use a smooth steady motion with enough force to allow the drill to cut. It may be necessary to raise the drill from time to time to allow the flutes to clear the material.
10. At the end of a drilling operation, press the stop button to turn **OFF** the machine.

### **Chip Characteristics**

If chips produced by your operation are blue and burnt and overheated, but the cutting speed is correct, reduce the feed rate until the chips are silver. If the chips are powdery, increase the feed rate so the chips are coarser but not overheated.

### **Indication of Extreme Speeds and Feeds**

A drill that splits up the web is evidence of too much feed or insufficient tip clearance at the center as a result of improper grinding. The rapid wearing away of the extreme outer corners of the cutting edges indicates that the speed is too high. A drill chipping or braking out at the cutting edges indicates that either the feed is too heavy, or the drill has been ground with too much tip clearance.

## **DRILLING RECOMMENDATIONS**

### **Speeds for Drilling**

The speed of a drill is usually measured in terms of the rate at which the outer periphery of the tool moves in relation to the work being drilled. The common term for this is Surface Feet per Minute (SFM). The relationship of SFM is expressed in the following formulas:

$$\text{SFM} = 0.26 \times \text{rpm} \times \text{Drill Diameter (in inches)}$$

$$\text{RPM} = 3.8 \times \{\text{SFM/Drill diameter [in inches]}\}$$

In general, the higher the speed the shorter the drill life. Operating at the low end of the speed range for a particular material will result in longer life. The most efficient speed for operating a drill depends on many variables:

- Composition and hardness of material.
- Depth of the hole.
- Type and condition of the drilling machine.
- Desired quality of the hole.
- Difficulty of set-up.



### Indication of Extreme Speeds and Feeds

A drill that splits up the web is evidence of too much feed or insufficient tip clearance at the center as a result of improper grinding. The rapid wearing away of the extreme outer corners of the cutting edges indicates that the speed is too high. A drill chipping or braking out at the cutting edges indicates that either the feed is too heavy or the drill has been ground with too much tip clearance.

### Drill Speed Guide

SPEED RANGE (RPM)	WOOD	ZINC DIECAST	ALUMINUM & BRASS	PLASTIC
	in (mm)	in (mm)	in (mm)	in (mm)
2600	1/4 (6.4)	3/16 (4.8)	5/32 (4.0)	1/8 (3.2)
1350 - 2100	3/8 (9.5)	1/4 (6.4)	7/32 (5.5)	3/16 (4.8)
1190 - 1350	5/8 (16.0)	3/8 (9.5)	11/32 (8.75)	5/16 (7.9)
720 - 1190	7/8 (22.0)	1/2 (12.5)	15/32 (12.0)	7/16 (11.0)
480 - 720	1-1/4 (31.75)	3/4 (19.0)	11/16 (17.5)	5/8 (16.0)
350 - 480	1-5/8 (41.4)	7/8 (22.0)	3/4 (19.0)	13/16 (20.5)
300 - 350	2 (50.8)	1 (25.4)	--	--



**Important:** This is a general speed chart. If your specific drill press is not rated for the rpm listed, then do not use this drill press for this operation. Use your drill press within the specifications listed at the front of the manual.



## LUBRICATION AND MAINTENANCE



**WARNING:** Make sure the electrical disconnect is OFF before working on the machine.

Maintenance should be performed on a regular basis by qualified personnel.

Always follow proper safety precautions when working on or around any machinery.

### Daily Maintenance

- Do a general cleaning by removing dust and chips from the machine.
- Check and tighten any loose mounting bolts.
- Sharpen or replace any worn or damaged tooling.
- Lubricate the quill gearing.
- Inspect the power plug and cord.
- Keep area around machine clear of debris.
- Check for any unsafe conditions (E-stop, limit switches) and fix immediately.
- Check that all nuts and bolts are properly tightened.



**Note:** When cleaning chips and debris from the machine, use a brush and a shop vacuum. **DO NOT** blow off the machine with compressed air. The force of the compressed air may force chips into critical mechanisms or may inflict injury to yourself or others.

### Weekly Maintenance

- Lubricate threaded components and sliding devices.
- Apply rust inhibitive lubricant to all non-painted surfaces.
- Clean the machine and the area around it.



**Note:** The non-painted surfaces on the drill press should be protected against rust and pitting. Wiping the machine clean after every use ensures that dust will not trap moisture against bare metal surfaces.

### Monthly Maintenance

- Check that all screws and bolts are tight and secure.
- Wipe built up grime from with a rag and a mild solvent.
- Check for worn or damaged electrical cables.



- Inspect belt regularly for tension and wear. Check pulleys to ensure that they are properly aligned.



**Note:** *Proper maintenance can increase the life expectancy of your machine.*

### **Greasing the Machine**

- Lubricate the spline of the spindle and the teeth of the rack with a #2 grease.
- Fully extend the spindle and lightly grease the spindle shaft.
- A coat of automotive type paste wax applied to the table and column will help to keep the surfaces clean.

### **Storing Machine for Extended Period of Time**

If the Drill Press is to be inactive for a long period of time, prepare the machine as follows:

- Detach the plug from the electrical supply panel.
- Clean and grease the machine.
- Cover the machine.





## TROUBLESHOOTING

**⚠ WARNING:** Make sure the electrical disconnect is OFF before working on the machine.

Trouble	Probable Cause	Remedy
Spindle does not run	Motor overload protector tripped	Let the motor cool down, and the overheat switch would be reset by itself, then push the start button.
	Chuck guard mis-adjustment	Adjust / Close the chuck guard.
	Defective switch.	Replace switch.
	Broken drive belt.	Replace drive belt.
Spindle noisy.	Damaged spindle bearings	Replace bearings.
	Worn spline.	Replace spline.
Drill stalls.	Worn drive belt.	Check condition of belt. Replace if glazed or slipping on pulleys.
	Excessive feed rate for size of drill and material being drilled. No cutting fluid or improper cutting fluid.	Reduce feed pressure or use cutting fluid. Use correct cutting fluid.
Poorly drilled holes.	Drill dull.	Sharpen drill.
	Lack of rigidity in hold-down method.	Check that all T-slot hold-downs are tight, and that table-lock and drill head bolts are tight.
	Speed too fast for material and drill size.	Check spindle speed recommendations. Reduce speed if necessary.
	Feed too fast for material and drill size.	Reduce feed rate.
	No or improper cutting fluid or coolant being used.	Use cutting fluid or change to proper fluid or coolant for material being drilled.
	Improperly ground drill bit.	Check for proper angles and reliefs. Regrind to proper geometry.
Motor overheating.	Electrical circuit fault.	Check amp draw in circuit. Make sure amp draw is the same as rating on motor plate.
	Oversize drill.	Reduce drill size.
	No cutting fluid, or wrong fluid.	Use correct cutting fluid for the material and drill.
Table cannot be raised.	Lack of lubrication.	Lubricate.



# PARTS DIAGRAM

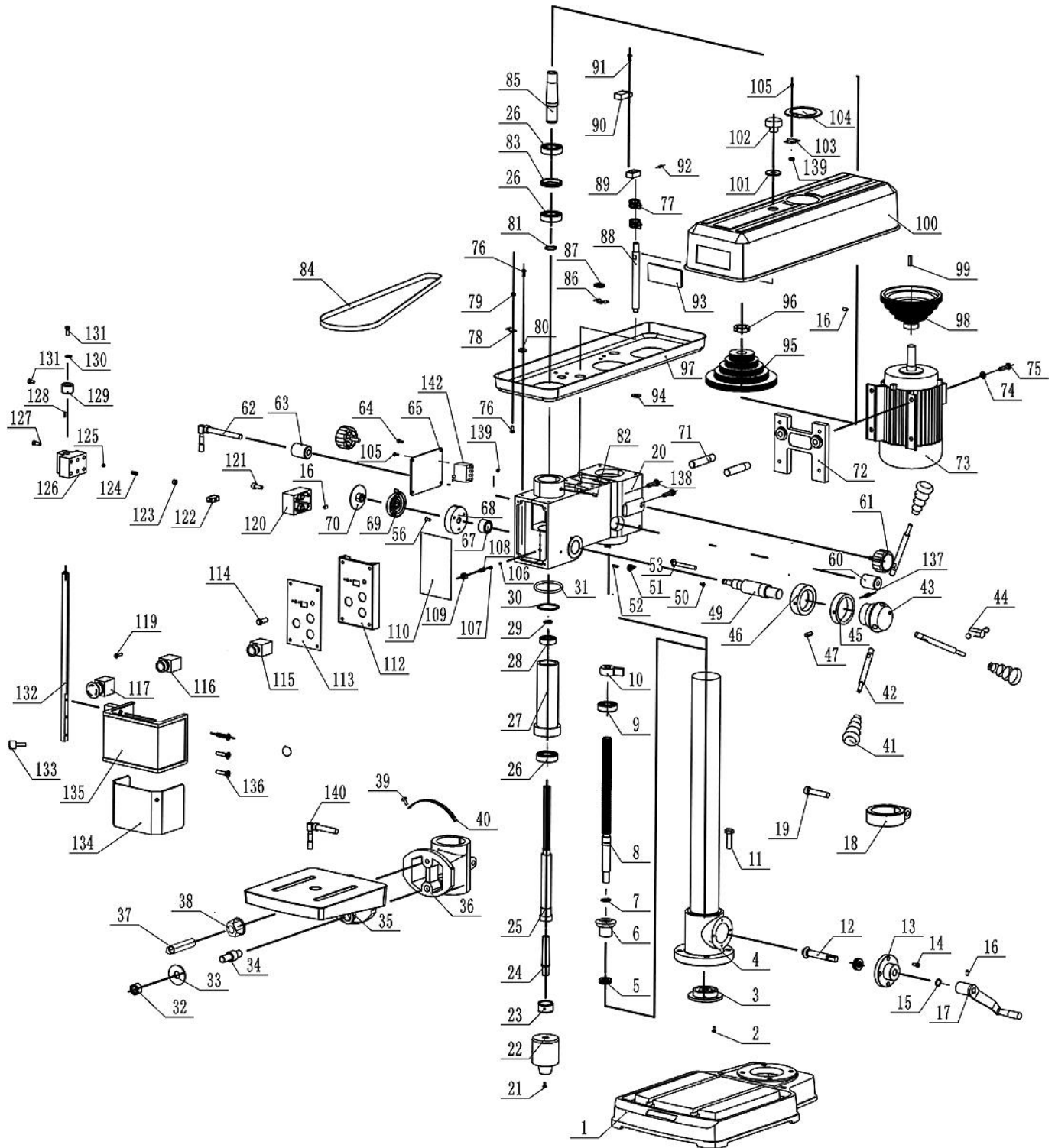



## Parts List

Item	Part No.	Description	Size	Qty.
1	S1601001	Base		1
2	M4X10GB818	Cross Pan Head Screw	M4x10	4
3	S1601002	Cover		1
4	S1601003	Column		1
5	BRG51102GB301	Thrust Bearing	51102	2
6	S1601005	Cone Gear		1
7	CLP20GB894D1B	C-Clip	M20	1
8	S1601006	Lead Screw		1
9	BRG6204GB276	Bearing	6204	1
10	S1601007	Nut		1
11	M12X40GB5783B	Hex Cap Screw	M12x40	4
12	S1601008	Cone Gear Shaft		1
13	S1601010	Cover		1
14	M5X12GB70B	Hex Socket Cap Screw	M5x12	4
15	CLP15GB894D1B	C-Clip	M15	1
16	M6X12GB77B	Set screw	M5x12	3
17	S1601009	Crank Arm Handle Assembly		1
18	S1601011	Retaining Ring		1
19	S1401012	Hex Socket Cap Screw	M12x60	1
20	S1602001	Headstock		1
21	M8X12GB70D3Z	Screw	M8x12	1
22	B16-1-16MM	Key Type Chuck	B16	1
23	S1603004	Nut		1
24	B16-MT2	Arbor	MT2/B16	1
25	S1603001	Spindle		1
26	BRG6205GB276	Bearing	6205	3
27	S1603002	Quill		1
28	BRG6203GB276	Bearing	6203	1
29	CLP17GB894D1B	C-Clip	M17	1
30	CLP40GB893D1B	C-Clip	M40	1
31	Φ50X4	Rubber Washer	φ50x4	1
32	M16GB6170B	Nut	M16	2



Item	Part No.	Description	Size	Qty.
33	WSH16GB96D1B	Flat Washer	M16	2
34	S1601016	Double End Bolt		1
35	S1601014	Table		1
36	S1601004	Table Support		1
37	M12X40GB35Z	Bolt	M12x40	1
38	M12GB6177D1	Nut	M12	2
39	RVT2D5X5GB827C	Rivet	M2.5x5	2
40	S1606001	Tilt Scale		1
41	S1604011	Grip		3
42	S1604005	Handle		3
43	S1604001	Hub		1
44	S1604004	Lock Handle Assembly		1
45	S1604013	Ring		1
46	S1604003	Scale Ring		1
47	PIN8X25GB879D1B	Pin	8x25mm	1
49	S1604002	Pinion Shaft		1
50	M4X8GB818B	Cross Pan Head Screw	M4x8	1
51	S1609009	Indicator		1
52	PIN4X16GB879D1B	Pin	4x16mm	2
53	S1604012	Bolt		1
56	M5X12GB818B	Cross Pan Head Screw	M5x12	3
60	S1602005	Pivot Block		1
61	S1609007	Locking Button		2
62	S1602015	Lock Handle		1
63	S1602004	Lock Block		1
64	M4X12GB818B	Cross Pan Head Screw	M4x12	4
65	S1602010	Cover		1
67	S1604006	Spacer		1
68	S1604008	Collar		1
69	S1604009	Coil Spring		1
70	S1604007	Spring Cover		1
71	S1602003	Motor Rod		2
72	S1602007	Motor Base		1
73	Y80	Motor	1/2HP,115V,60Hz,6P	1
74	WSH8GB97D1B	Flat Washer	M8	4



Item	Part No.	Description	Size	Qty.
75	M8X30GB5783B	Hex Cap Screw	M8x30	4
76	M5X12GB818B	Cross Pan Head Screw	M5x12	11
77	S1609010	Fastener		2
78	S1605014	Plate		2
79	M5GB6173B	Nut	M5	4
80	S1605011	Strain Relief		1
81	CLP25GB894D1B	C-Clip	M25	1
82	M6X12GB78B	Set screw	M6x12	1
83	S1602023	Spacer		1
84	S1605007	Poly V-Belt	450J	1
85	S1602022	Driving Sleeve		1
86	S1605013	Plate		2
87	S1605010	Rubber Sleeve		2
88	S1605009	Shaft		1
89	S1606014	Proximity Switch Seat		1
90	LJC1-3/24	Proximity Switch		1
91	M4X16GB818B	Cross Pan Head Screw	M4x16	2
92	M6X8GB77B	Set screw	M6x8	1
93	BL	Logo		1
94	S1605012	Foam Pads		6
95	S1605006-01	Spindle Pulley		1
96	M24X1.5GB6173B	Nut	M24x1.5	1
97	S1605002	Pulley Cove		1
98	S1605005-01	Motor Pulley		1
99	PIN6x6x40GB1096D	Flat Key	6x6x40mm	1
100	S1605001	Pulley Cove		1
101	WSH12GB97D1B	Flat Washer	M12	1
102	S1605008	Locking Button		1
103	S1605004	Hinge		1
104	S1605003	Plate		1
105	M4X8GB818B	Cross Pan Head Screw	M4x8	4
106	6mm	Steel Ball	6mm	1
107	0.5X4.5X5.94GB2089B	Spring	0.5x4.5x5.94mm	1
108	M8X12GB77B	Set Screw	M8x12	1
109	M8GB6173B	Nut	M8	1





Item	Part No.	Description	Size	Qty.
110	S1602011	Insulating Paper		1
112	S1602008-01	Panel Bracket		1
113	S1606013	Panel		1
114	ZSD-AC24V	Indicator light	ZSD-AC24V	1
115	LA115-A5-10BN	Start Switch	LA115-A5-10BN	1
116	LA115-A5-01BN	Stop Switch	LA115-A5-01BN	1
117	LA115-A5-01ZS	Emergency Stop Switch	LA115-A5-01ZS	1
119	M5X40GB818B	Cross Pan Head Screw	M5x40	1
120	S1409005	Block		1
121	M8X20GB70D1B	Hex Socket Cap Screw	M8x20	2
122	AV-165-1C25C	Micro Switch	AV-165-1C25C	1
123	M10X8GB77B	Set Screw	M10x8	2
124	1X6X15.75GB2089B	Spring	1x6x15.75	2
125	8mm	Steel Ball	8mm	2
126	S1609004	Chuck Guard Micro Switch Assembly		1
127	M6X35GB70D1B	Hex Socket Cap Screw	M6x35	4
128	PIN3X10GB879D1B	Pin	3x10mm	1
129	S1609006	Spacer		1
130	WSH6GB97D1B	Flat Washer	M6	1
131	M6X12GB70D1B	Hex Socket Cap Screw	M6x12	1
132	S1609001	Chuck Guard Rod		1
133	S1609008	Shifter Bolt		1
134	LS1609000-01	Chuck Guard		1
135	LS1609000	Chuck Guard		1
136	M6X40GB819D1Z	Screw	M6x40	1
137	M5X6GB77B	Set screw	M5x6	1
138	M10X35GB5783B	Hex Cap Screw	M10x35	2
139	M4GB6173B	Nut	M4	4
140	M12X60GB70D1B	Column Lock Handle		1
142	DZ07B, 110~120V	Relay		1
	DP-ACC-01	Chuck Key (not shown)		1
	DP-ACC-02	Slant Wedge (not shown)		1
	DP-ACC-03	L-Hex Wrench (not shown)	2.5mm	1
	DP-ACC-04	L-Hex Wrench (not shown)	3mm	1



Item	Part No.	Description	Size	Qty.
	DP-ACC-05	L-Hex Wrench (not shown)	5mm	1
	DP-ACC-06	L-Hex Wrench (not shown)	10mm	1

**NOTES**



**BAILEIGH INDUSTRIAL HOLDINGS LLC**  
**1625 DUFEK DRIVE MANITOWOC, WI 54220**  
**PHONE: 920. 684. 4990 FAX: 920. 684. 3944**  
**[www.baileigh.com](http://www.baileigh.com)**

**BAILEIGH INDUSTRIAL HOLDINGS LTD. UNIT D SWIFT POINT**  
**SWIFT VALLEY INDUSTRIAL ESTATE, RUGBY**  
**WEST MIDLANDS, CV21 1QH UNITED KINGDOM**  
**PHONE: +44 (0)24 7661 9267 FAX: +44 (0)24 7661 9276**  
**[WWW.BAILEIGH.CO.UK](http://WWW.BAILEIGH.CO.UK)**