



SZ20-CN/EN-A02

Creator 3

USER GUIDE



This guide is only applicable to FLASHFORGE Creator 3 3D printer

PREFACE

Note: Each device must be tested before leaving factory. If there are some residues in extruder or some tiny scratches on the build tape, it is normal and won't affect the printing quality.

On the completion of this User Guide, thanks all FlashForge engineers and the FlashForge 3D printer users for their unremitting efforts and sincere assistance.

The FlashForge Creator 3 User Guide is designed for the Creator 3 users to start their printing journey with FlashForge Creator 3. Even if you are familiar with earlier FlashForge machines or 3D printing technology, we still recommend that please read this guide, as there is lots of important information about the Creator3 for you to get a better 3D experience.

For a better and more successful printing experience, you can refer to the following materials:

(1) User Guide:

Users will find the User Guide together with the printer accessories. The User Guide will help you start your print journey as soon as possible.

(2) Official FlashForge Website:

FlashForge Chinese website: www.sz3dp.com

FlashForge English website: www.flashforge.com

The official FlashForge website contains the up-to-date information concerning FlashForge software, firmware, device maintenance and so on. Users are also able to get the contact information from there.

NOTICE

PLEASE STRICTLY FOLLOW ALL THE SAFETY WARNINGS AND NOTICE BELOW ALL THE TIME.

WORK ENVIRONMENT SAFETY

- ◆ Keep your work place tidy.
- ◆ Do not operate Creator 3 in the presence of flammable liquids, gases or dust.
- ◆ Keep Creator3 out of children and untrained persons' reach.

ELECTRICAL SAFETY

- ◆ Always use the Creator3 with a properly grounded outlet. Do not refit Creator3 plug.
- ◆ Do not use Creator3 in damp or wet locations. Do not expose Creator3 to burning sun.
- ◆ In case of device damage, please use the power supply provided by FlashForge.
- ◆ Avoid using the device during an thunderstorm.
- ◆ In case of uncertain accident, please unplug the device if you do not use it for long.

PERSONAL SAFETY

- ◆ Do not touch the nozzle and build plate during printing.
- ◆ Do not touch the nozzle after finishing printing.
- ◆ Dress properly. Do not wear loose clothing or jewelry. Keep your hair, clothing and gloves away from moving parts.
- ◆ Do not operate the device while you are tired or under the influence of drugs, alcohol or medication.

CAUTIONS

- ◆ Do not leave the device unattended for long.
- ◆ Do not make any modifications to the device.
- ◆ To lower the build plate before loading/unloading filament. (The distance between the nozzle and build plate should be kept for at least 50mm)
- ◆ Operate the device in a well-ventilated environment.
- ◆ Never use the device for illegal activities.
- ◆ Never use the device to make any food storage vessels.
- ◆ Never use the device to make any electrical appliance.
- ◆ Never put the model into your mouth.
- ◆ Do not remove the models with force.
- ◆ Never connect the device with network cable longer than 3m.

ENVIRONMENT REQUIREMENTS

- ◆ Temperature: RT 15-30°C
- ◆ Moisture: 20%-70%

PLACE REQUIREMENTS

- ◆ The device must be placed in a dry and ventilated environment. The distances of the left, right and back side space should be at least 20cm, and the distance of the front side space should be at least 35cm.

FILAMENT REQUIREMENTS

- ◆ Do not abuse the filament. Please make sure you use the FlashForge filament or the filament from the brands accepted by FlashForge.

FILAMENT STORAGE

- ◆ All polymers degrade with time. Do not unpack until filament is needed. Filament should be stored at clean and dry conditions.

LEGAL NOTICE

- ◆ All the information in this document is subject to any amendment or change without the official authorization from FlashForge.
- ◆ FLASHFORGE CORPORATION MAKES NO WARRANTY OF ANY KIND WITH REGARD TO THIS DOCUMENT, INCLUDING, BUT NOT LIMITED TO, THE IMPLIED WARRANTIES OF MERCHANTABILITY AND FITNESS FOR A PARTICULAR PURPOSE.
- ◆ FlashForge shall not be liable for errors contained herein for incidental consequential damages in connection with furnishing, performance or use of this material.
- ◆ Flashforge reserves the right to modify the User guide due to subsequent equipment updates.
- ◆ Copyright © 2020 FlashForge Corp. All Rights Reserved

FCC STATEMENT

- ◆ This device complies with Part 15 of the FCC Rules. Operation is subject to the following two conditions:
 - (1) This device may not cause harmful interference,
 - (2) This device must accept any interference received, including interference that may cause undesired operation.
- ◆ Warning: Changes or modifications not expressly approved by the party responsible for compliance could void the user's authority to operate the equipment.
- ◆ This equipment has been tested and found to comply with the limits for a Class B digital device, pursuant to Part 15 of the FCC Rules. These limits are designed to provide reasonable protection against harmful interference in a residential installation. This equipment generates uses and can radiate radio frequency energy and, if not installed and used in accordance with the instructions, may cause harmful interference to radio communications. However, there is no guarantee that interference will not occur in a particular installation. If this equipment does cause harmful interference to radio or television reception, which can be determined by turning the equipment off and on, the user is encouraged to try to correct the interference by one or more of the following measures:
 - Reorient or relocate the receiving antenna.
 - Increase the separation between the equipment and receiver.
 - Connect the equipment into an outlet on a circuit different from that to which the receiver is connected.
 - Consult the dealer or an experienced radio/TV technician for help.
- ◆ This document contains proprietary information protected by copyright.

SERVICE

- ◆ Always unplug Creator 3 from its power before performing any service procedures. Failure to do so may result in personal injury and equipment damage.
- ◆ Use only Creator 3 approved materials and components. Use of object materials, or 3D objects other than FlashForge approved object materials and genuine FlashForge components may void warranty.

CONTENT

1. Introduction	05
1.1 About Creator3	05
1.2 Accessories	06
1.3 Product Parameters	07
1.4 Terms	08
2. Unpacking and Hardware Assembly	09
2.1 Unpacking	09
2.2 Hardware Assembly	12
3. First Installation	13
3.1 Leveling	13
3.2 Filament Installation	15
3.3 Loading and Unloading	17
3.4 Calibration	19
3.5 Internet Connection	22
3.6 Flashforge Software	23
3.6.1 Software Installation	23
3.6.2 Software Interface	23
3.6.3 Set Dual Extruder Print	24
4. Operation	28
4.1 Filament	28
4.1.1 Filament Compatibility	28
4.1.2 Print Setting	28
4.2 Print Start-up	29
4.3 Model Removal	32
4.4 Support Removal	32
4.5 Camera Connection	33
5. Introduction of Touch Screen	36
5.1 Print	36
5.2 Preheat	38
5.3 Tools	39
6. Maintenance	47
6.1 Log Copy	47
6.2 Maintenance and Service	47
6.3 Extruder Unclogging	48
6.4 Daily Maintenance and Use Suggestion	48
7. Support and Service	49

1. Introduction

1.1 About Creator 3

Device View

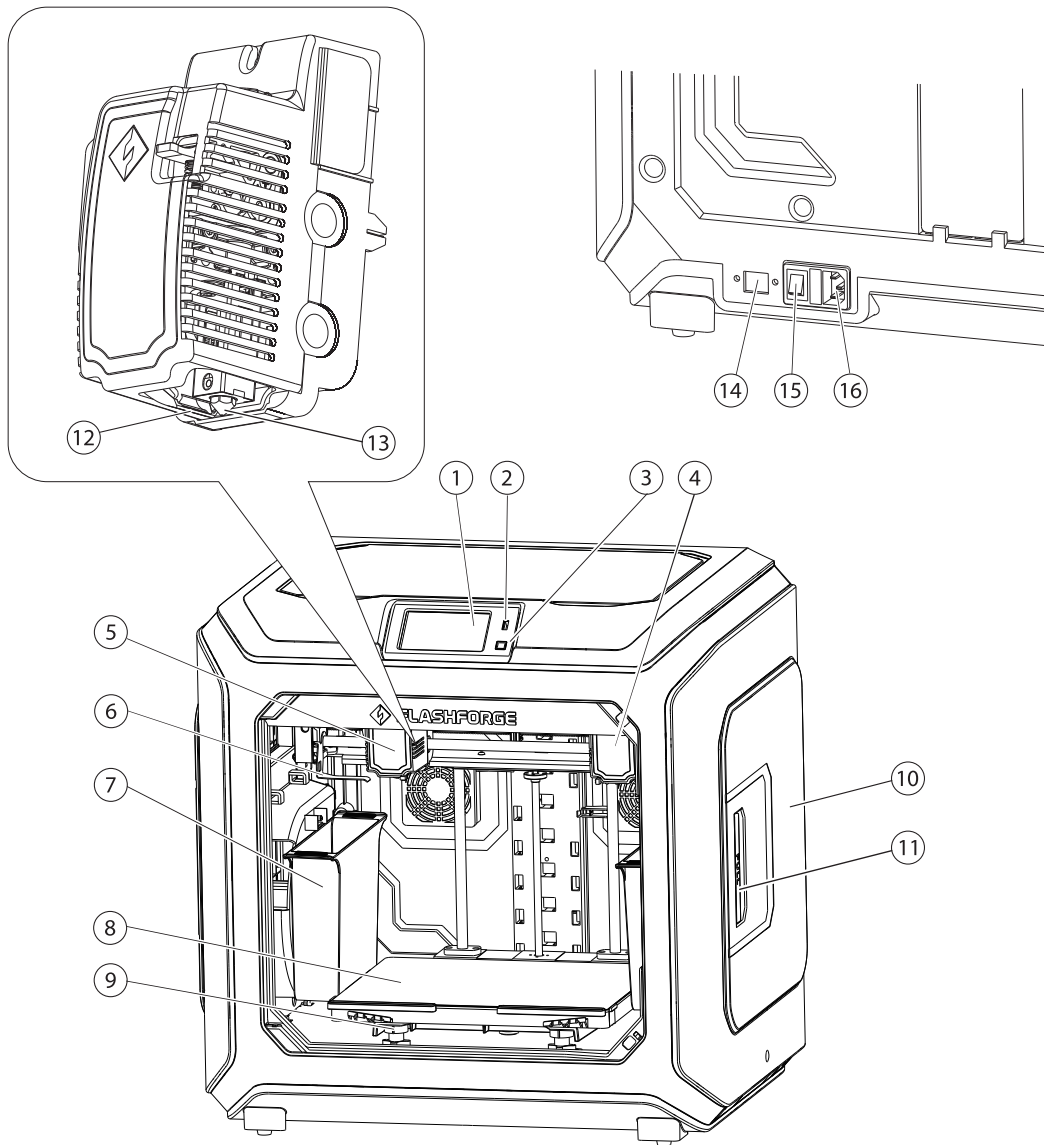

- 1. Touch screen
- 2. USB stick input
- 3. Touch screen button
- 4. Right extruder

- 5. Left extruder
- 6. Anti-oozing Plate
- 7. Waste box
- 8. Build plate

- 9. Leveling nut
- 10. Filament cover
- 11. Filament cover handle
- 12. Wind guide nose

- 13. Nozzle
- 14. Ethernet Input
- 15. Power switch
- 16. Power input

1.2 Accessories

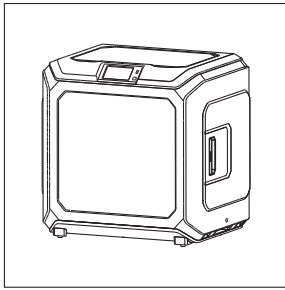

Creator 3

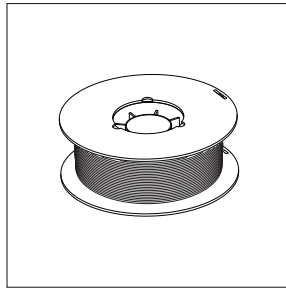

Filament

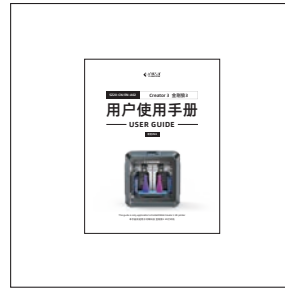

User Guide



After-sales Card

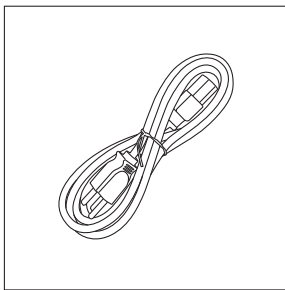

Power cable

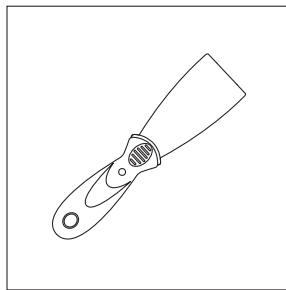

Scraper

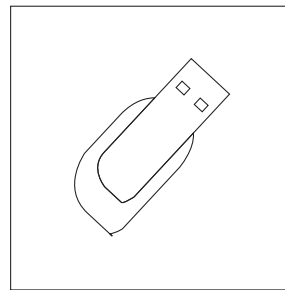

USB Stick

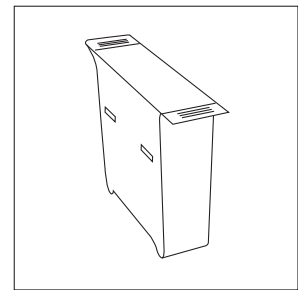

Waste box

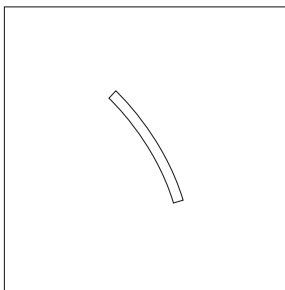

PTFE Tube

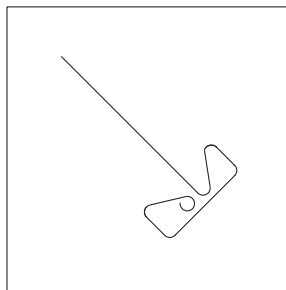

Unclogging Pin Tool

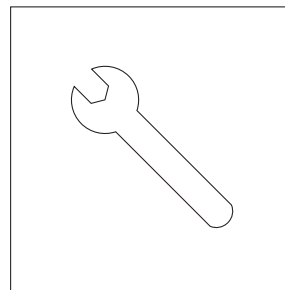

Stamping wrench

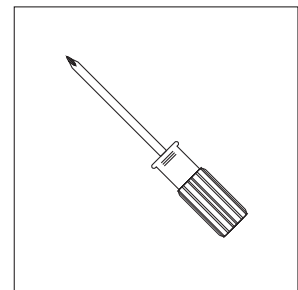

Screw driver

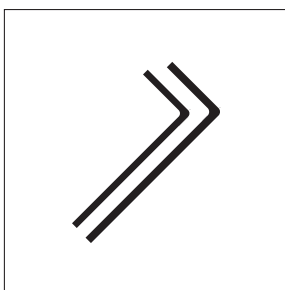

Allen wrench

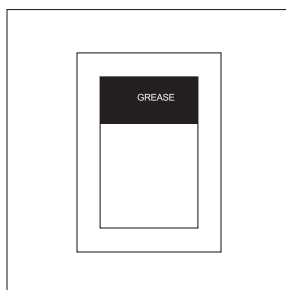

Grease

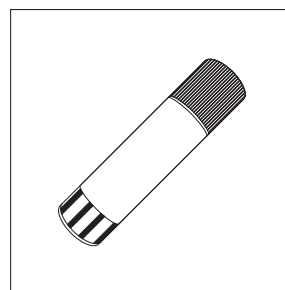

Glue stick

1.3 Product Parameters

Name	Creator 3
Number of Extruder	2, independent
Print Technology	Fused Filament Fabrication(FFF)
Screen Size	4.5" color IPS Touch Screen
Build Volume	300×250×200mm
Layer Resolution	0.05 - 0.4mm
Build Accuracy	±0.2mm
Positioning Accuracy	Z axis 0.0025mm; XY axis 0.011mm
Print Filament	PLA/ABS/PC/PVA/HIPS/PETG/wood filament/Nylon
Filament Diameter	1.75mm (±0.07mm)
Nozzle Diameter	0.4mm
Print Speed	10~150 mm/s
Travel speed	10~150 mm/s
Software	FlashPrint
Support Format	Input: 3MF/STL/OBJ/FPP/BMP/PNG/JPG/JPEG Output: GX/G
Operation system	Win XP/Vista/7/8/10、 Mac OS、 Linux
Device Size	627×485×615mm
Net Weight	40Kg
AC Input	Input: 100V-240VAC, 47-63Hz Power: 500W
Connectivity	USB Stick, Wi-Fi, Ethernet,

1.4 Terms

Build Plate	The surface on which the Creator3 builds an object.
Build Tape	The blue tape that covers Creator3's build plate so that the object can stick to the build plate well.
Build Volume	The three dimensional amount of space that an object will use once it is completed. The largest build volume of Creator3 is 300*250*200 mm.
Leveling Nuts	Nuts under the build platform that are used for adjusting the distance between the nozzle and build plate.
Extruder	The device that draws the filament from the spool, melts it and pushes it through a nozzle into the build plate.
Nozzle	Also called "print head" , which located at the bottom of the extruder where heated filament is squeezed out.
Nozzle fan	Used to lower extruder temperature and speed up filament solidification.
Filament Intake	An opening located at the top of the extruder.
Filament Cartridge	A specific box for placing FlashForge filament.
Filament Guide Tube	A plastic piece that guides the filament from the filament box to the filament intake.
Glue Stick	A solid adhesive used for making the model stick to the build plate firmly.
Unclogging Pin Tool	A tool that used for cleaning and unclogging the extruder.
Stamping Wrench	A tool that used for seizing the nozzle's metal cube.
Nozzle brush	Used to clean extruder waste.

2. Unpacking and Hardware Assembly

2.1 Unpacking



1. Cut off packaging ties, and tear off stretch wrap.



2. Lift outer packing box.



3. Remove top foam.

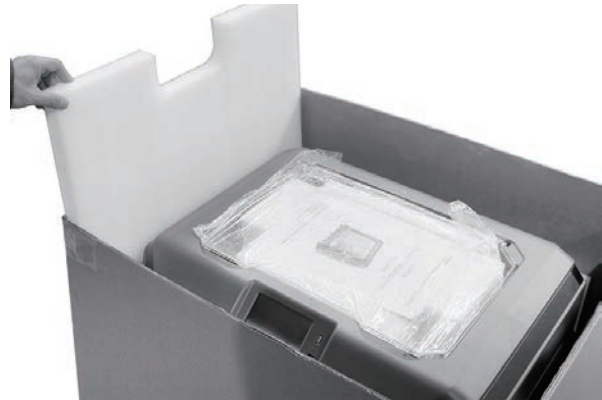

4. Remove foam around the printer.



5. Unrip tapes on four corners of the printer, take bubble pack down.



6. Remove tapes on the top, open head cover.



7. Take top parts and foam out.

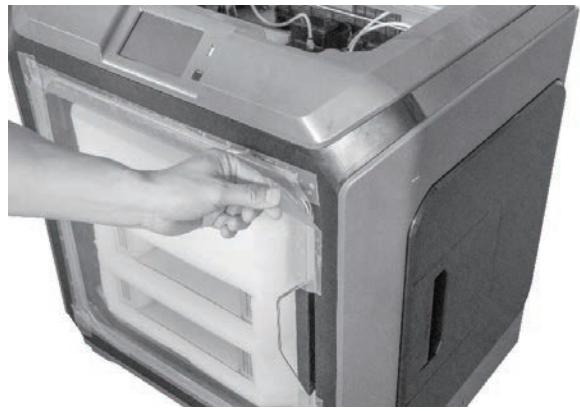

8. Remove the blue fastening tape.



9. Open the front door and take out the front foam which should contain two filament spools and two waste boxes.

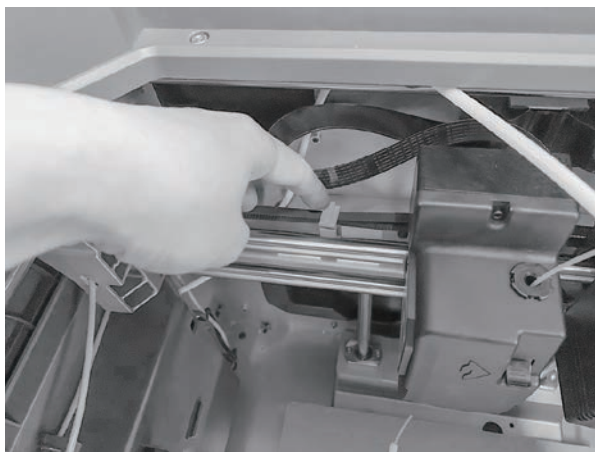
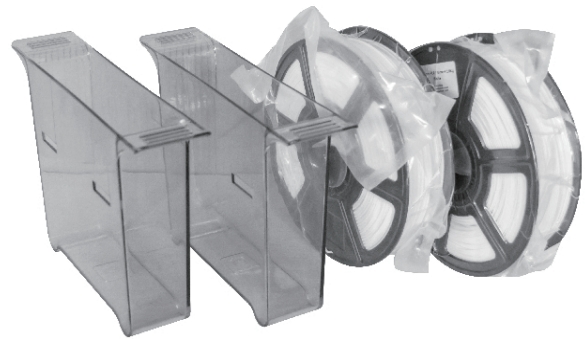

10. Remove clips on timing belt of X axis and Y axis.

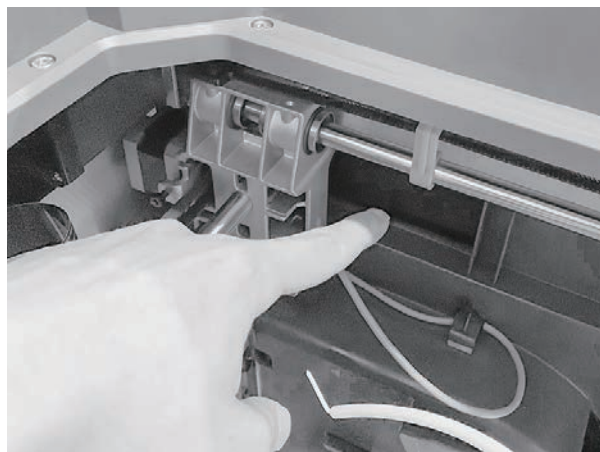

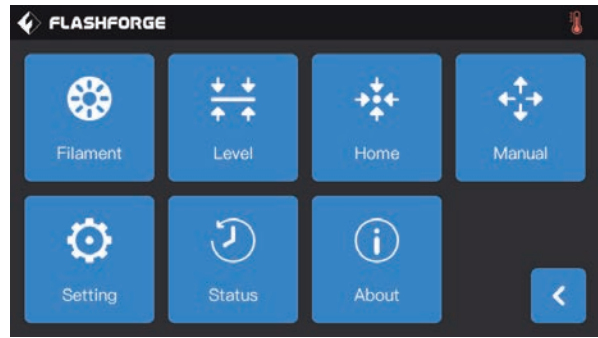
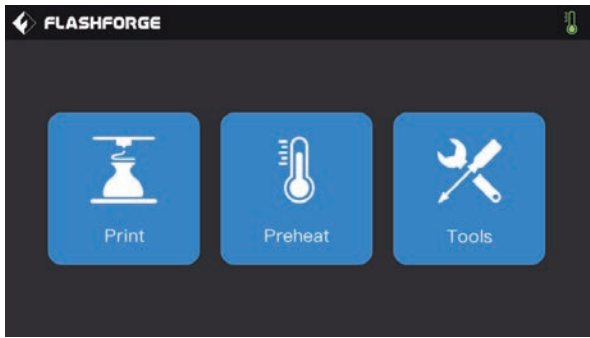

11. Insert power cable into power input of the printer back ,turn the power on.After that, tap[Tools]-[Manual] in turns to operate interface.



12. Tap[Z-]continuously until build plate rises to a high position ,thus taking out foam below easily.



13. Remove foam pieces under build plate.



14. Unboxing completed!Suggest to keep your accessories well for further use and transportation.

2.2 Hardware Assembly

Install Waste box

Take out waste box, hang it on the hookbeside build plate.
(One waste box on each side)

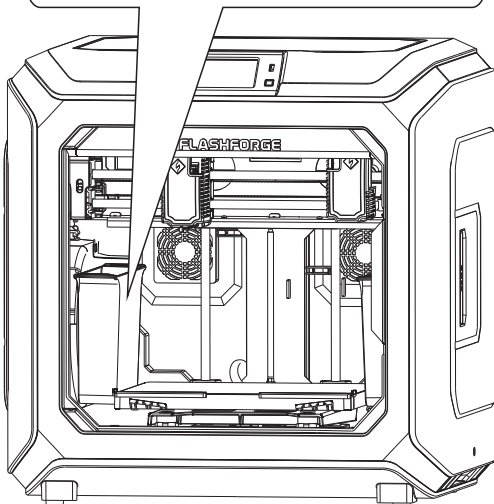
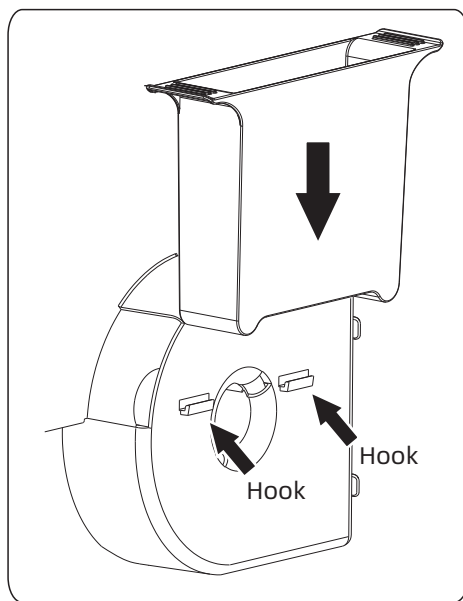
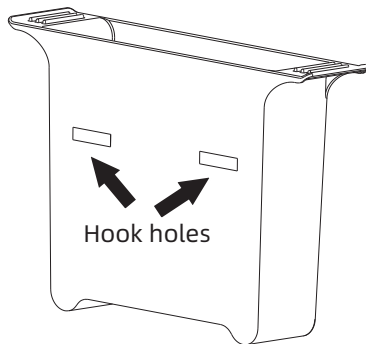

Install Anti-oozing Plate

Please make sure the nozzle touch the anti-oozing plate properly when installed. It is ok to adjust the distance between the nozzle and plate manually. It is normal to see the scratches on the surface of the plate after printing for several times.

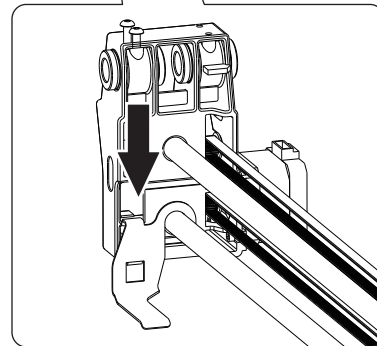
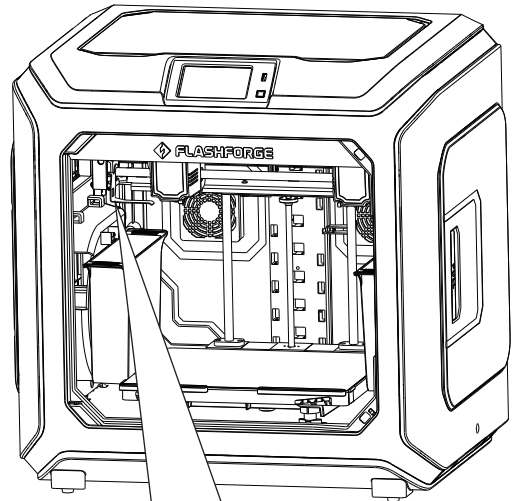

3. First Installation

3.1 Leveling

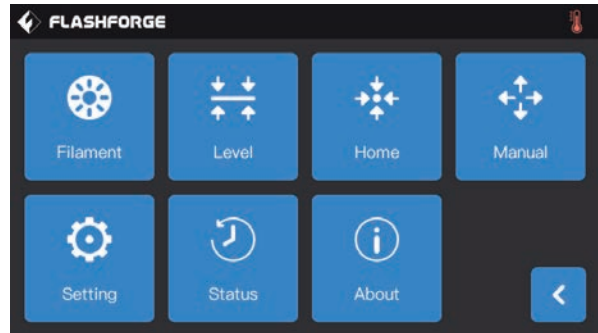
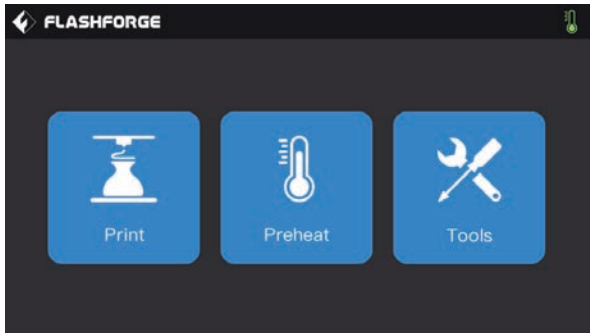

1. Tap[Tools]-[Level] in turns on the touch screen, leveling starts.

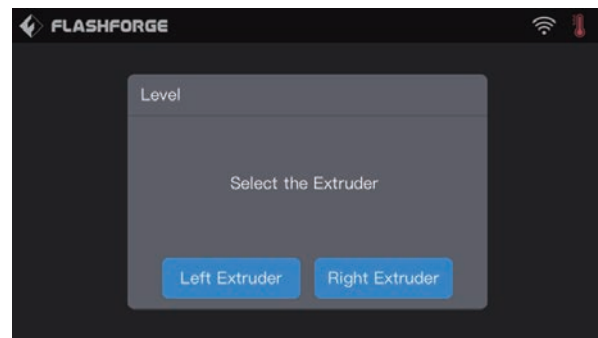
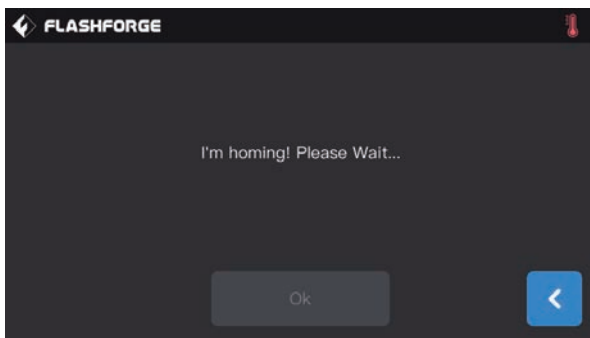

2. After extruder and build plate stop moving,choose left/right extruder to do the leveling.

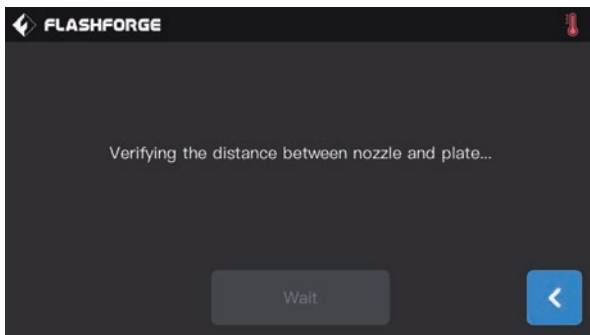

3. After choosing completed, extruder moves to the first point to do the verify distance between nozzle and plate.After verifying completed,extruder moves to the second point to do the leveling.

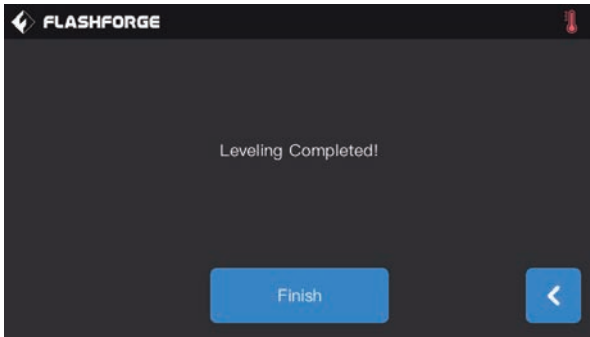
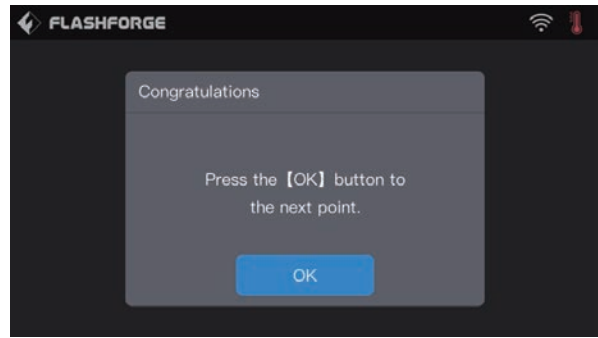
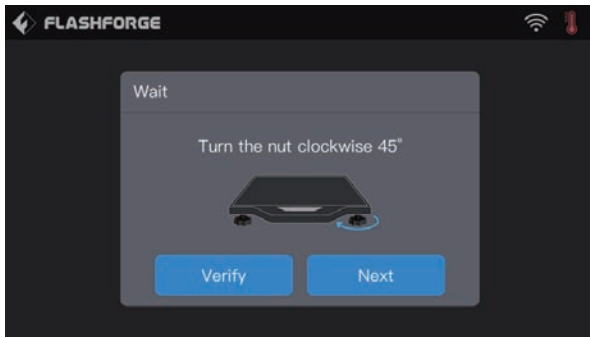

4. Wait for the extruder verifying distance between nozzle and plate on the second point and third point. If the distance between nozzle and plate is not appropriate, operate according to the instruction on the touch screen. After verifying completed, extruder moves to the third point, repeat the above steps to verify the distance as well. After finishing the third point, leveling completed.

Note: If leveling failed tip shown up on the touch screen, please repeat the leveling operation according to instructions until leveling finished.

3.2 Filament Installation

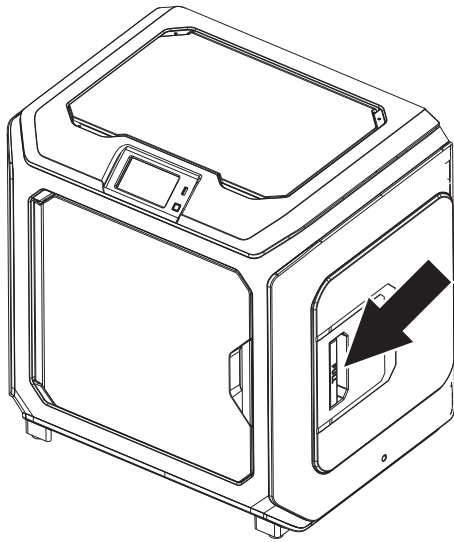

1. Open the filament cover.

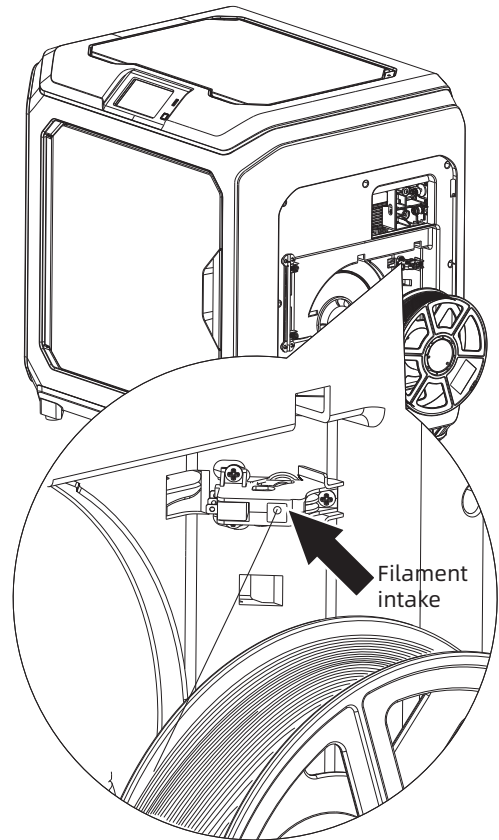

2. Insert the filament into filament intake.

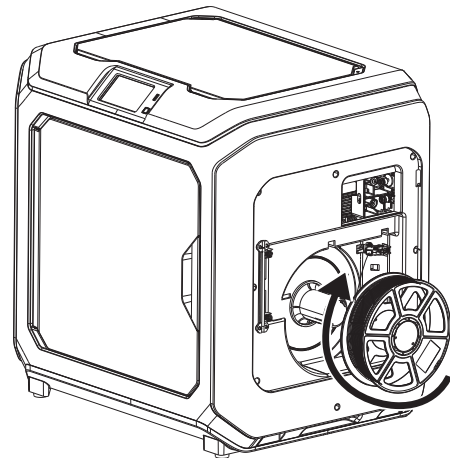
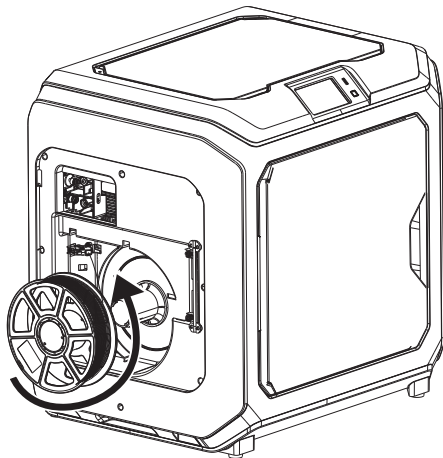

3. Notice: For filament convenient rotation, please install filament follow the direction shown in the picture.

**When installing filament on the left side, please unload filament anticlockwise;
when installing filament on the right side, please unload filament clockwise.**

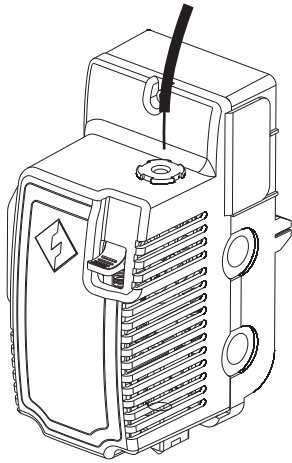

4. Insert filament into filament intake continuously until filament goes through filament guidetube.

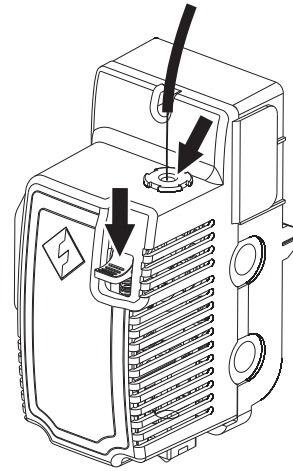

5. Press the spring presser, put filament vertically into the left filament intake to the bottom.

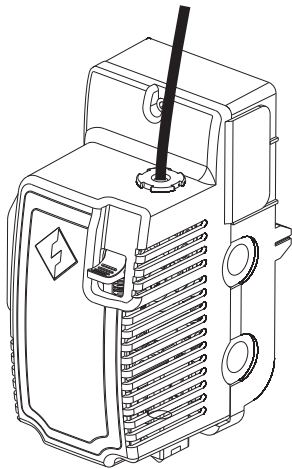

6. Insert filament guidetube into filament intake to fix.

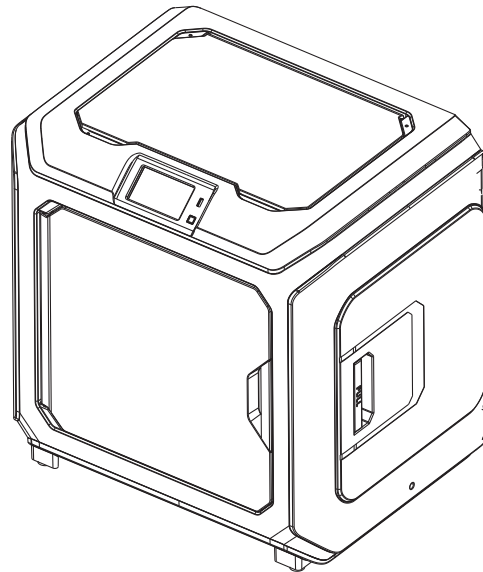

7. Put the spool of filament on the spool holder, close the filament cover.

3.3 Loading and Unloading

[Loading]

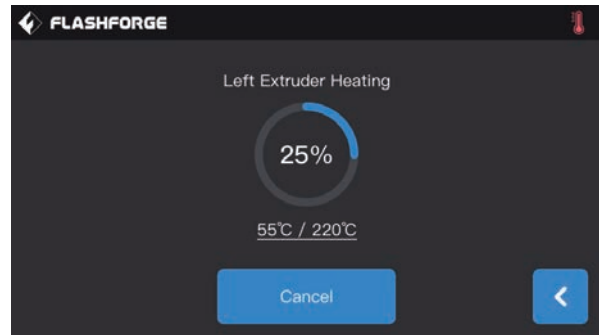
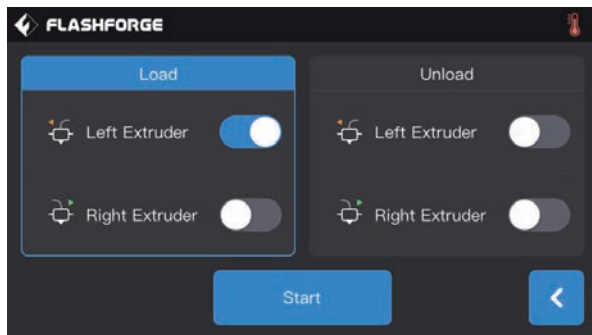
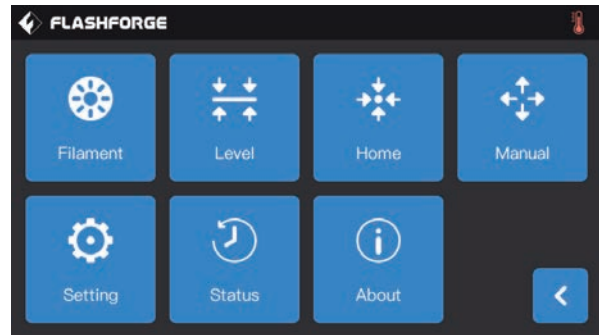
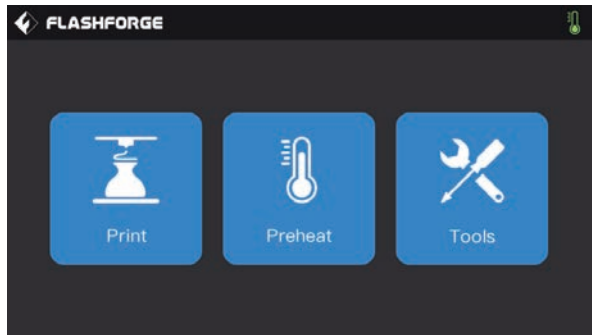

1. Tap [Tools]-[Filament]-target extruder[Load] in turns on the touch screen, wait for extruder heating up.

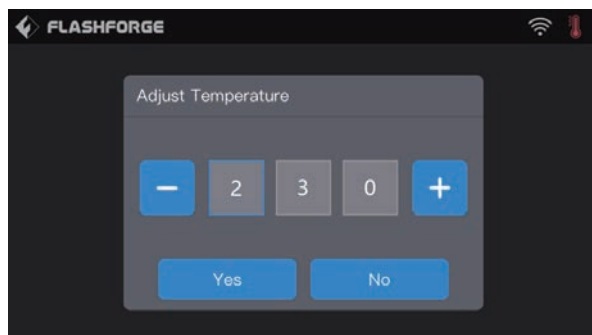

Click the temperature value, and a window for modifying the temperature value will pop up . The default filament loading temperature is 220 degrees. When high temperature filament such as ABS/ PC are needed, please click to modify the temperature value.

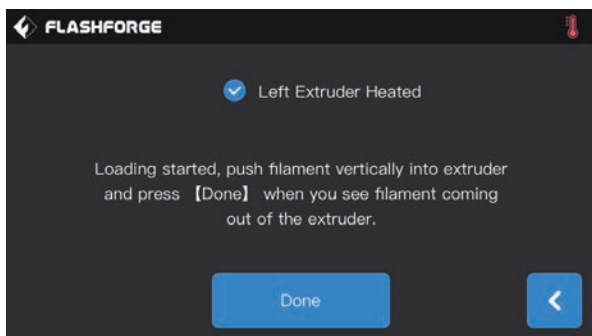

2. Install filament spool on the printer, thread filament through filament detecting components; Insert filament into filament intake until filament goes through white filament guidetube.

- When extruder heated up to the target temperature,press down the spring presser with left hand, and insert filament into filament intake until filament drive gear starts to load filament. Let white filament go,and insert white filament guidetube into extruder filament intake.
- Wait for even filament from nozzle. If is filament changing, please wait for same color of filament, then stop loading.

Note: Please loading before inserting filament into filament guidetube.Insert filament guidetube into filament intake after loading completed.

[Unloading]

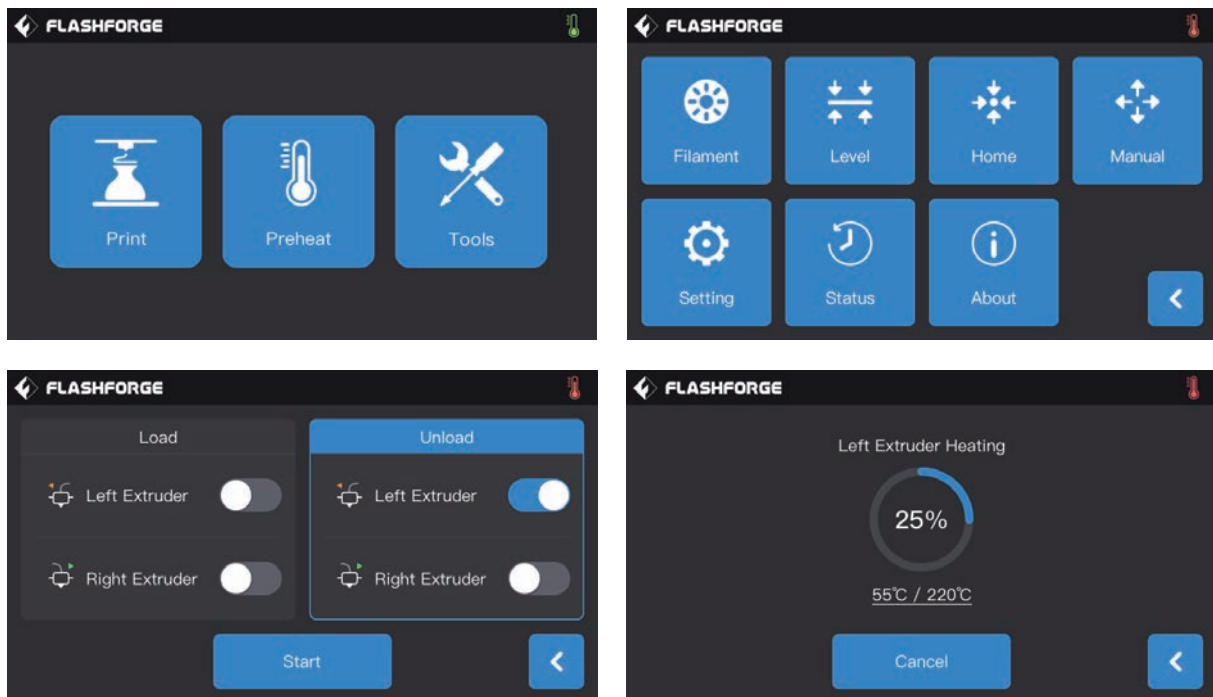

- Tap [Tools]-[Filament]-target extruder[Unload] in turns on the touch screen, wait for extruder heating up.

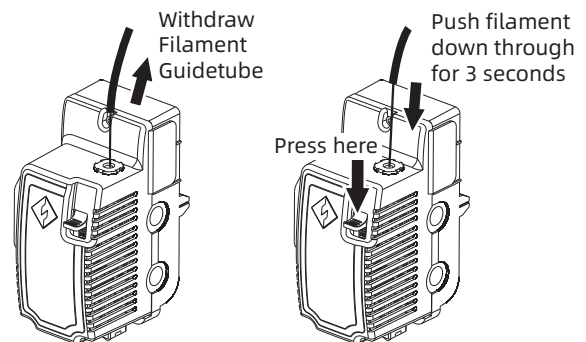
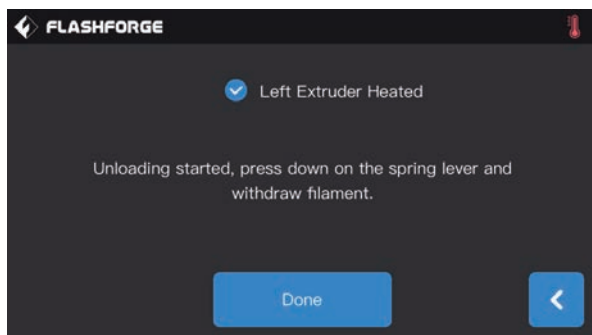

- When extruder heated up to the target temperature, wait for even filament from nozzle.Now,press down spring presser with left hand, pull out white filament guide tube with right hand, pull out filament quickly,unloading completed.

3.4 Calibration

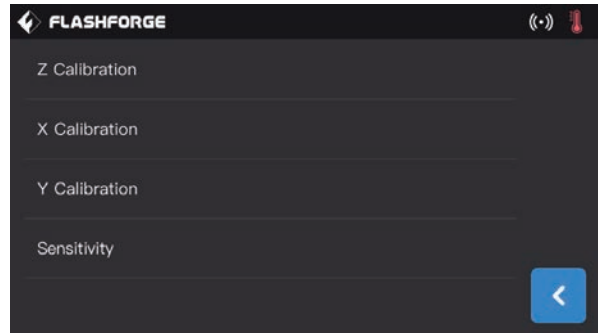
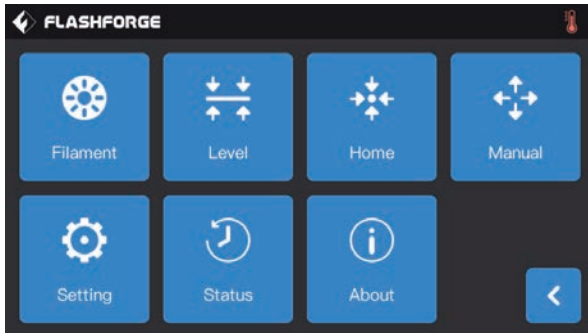

Tap [Tools]-[Setting]-[Calibration] in turns on the touch screen.

[Z axis calibration]

1. Do leveling before Z axis calibration,leveling see Page 13.

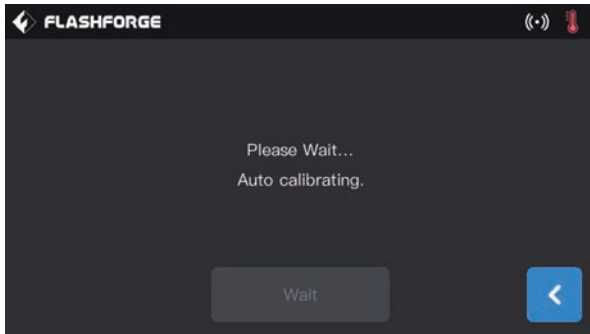

2.Tap[Z axis calibration],wait for calibration between nozzle and Z axis without pausing.

[Setting]-[Calibration]-[Sensitivity]

[Sensitivity]: shows the sensitivity of sensor in the nozzle. The higher the value, the lower the sensitivity;
When the sensitivity is too strong, it may cause an error report of z-axis calibration abnormal. When the equipment often prompts the z-axis calibration abnormal, please adjust the sensitivity of the sensor;Increase the value.
This function is factory default setting.

How to use this function?

When creator3 keeps reminding "please recalibration z-axis" or "z-axis error" before printing, and the platform continues to move upward after touching with the nozzle during manual adjustment.Your printer's sensor of z axis calibration may have malfunctioned.
Please follow the following steps to adjust.

Click[Setting]-[Calibration]-[Sensitivity]

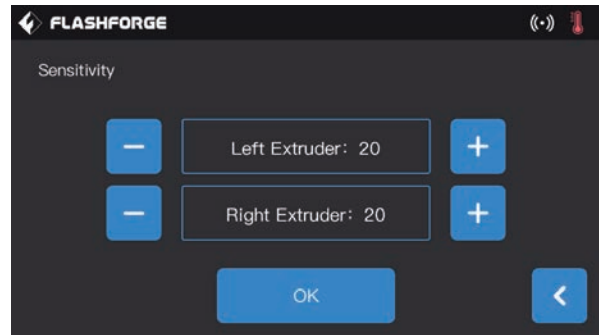
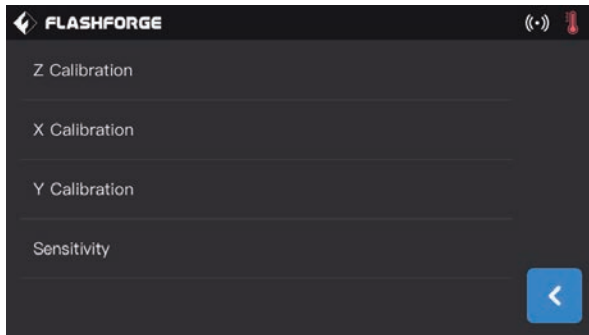

- The value should be adjusted to a larger value greatly if the piezoelectric plate is too sensitive.
- The value should be adjusted to a smaller value if the piezoelectric plate is not sensitive.
- Normal values are recommended at 20-25.
- When z-axis stops in the middle or stops without touching with the nozzle during printing, the corresponding nozzle sensitivity value should be increased.
- When the platform is still moving upward after contacting with the nozzle, the corresponding nozzle sensitivity value should be reduced.

[X axis calibration]

By comparing if printing lines of two extruders coincide in the direction of X axis to judge if two extruders in the same X-axis.

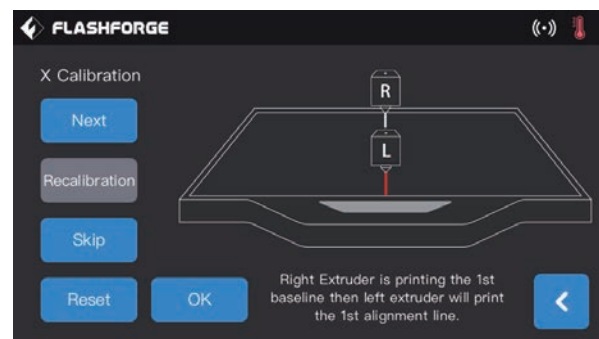

1. Tap[X axis calibration],wait for two extruders heating up to the target temperature, two extruders print one line in turns. After printing completed,check if two lines coincide; In the meanwhile, a confirmation notice pops up.

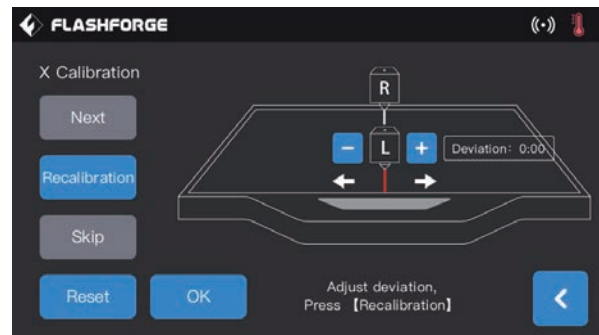
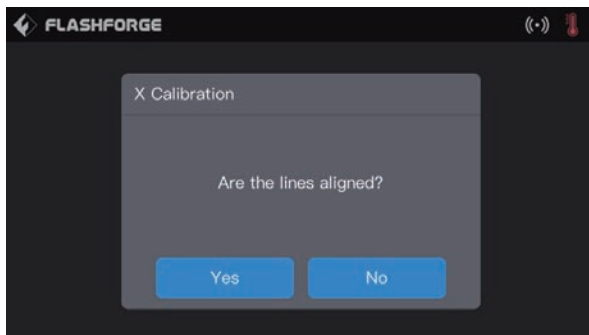

2. When the two lines do not coincide, click the next step, and there will be a prompt pop-up operation, and the nozzle will adjust the deviation to the left or right.

- **Next step:** shows judge next prompt operation and operate.
- **Recalibration:** The left and the right nozzle reprints one straight line respectively.
- **Skip:** The user knows that the two lines do not coincide, so there is no need to do the next prompt operation, so he can directly click "skip" to adjust the value deviation setting.
- **Confirm:** Save adjustive deviation value.
- **Back:** Exit the calibration page directly without saving the data in the face of the current operation.

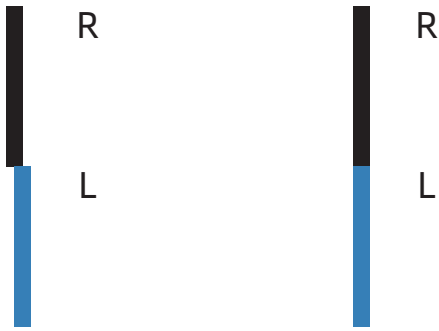

Deviation of two straight line Two straight lines coincide

Please click the icon as shown in the picture and adjust the nozzle with the left nozzle as the indicator. Estimate the deviation. Enter the estimated value and click "recalibrate"; Repeat the above steps until the two lines coincide.

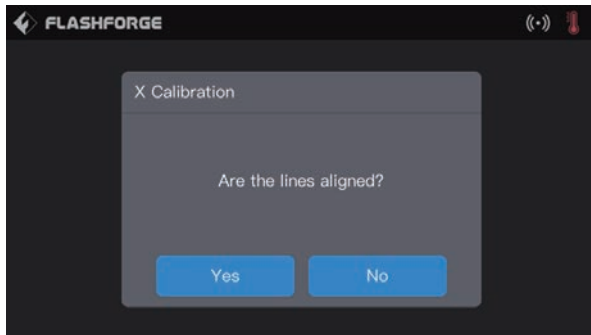

3. If two lines coincide completely, tap [Yes], X axis calibration completed.

[Y axis calibration]

By comparing if printing lines of two extruders coincide in the direction of Y axis to judge if two extruders in the same Y axis.

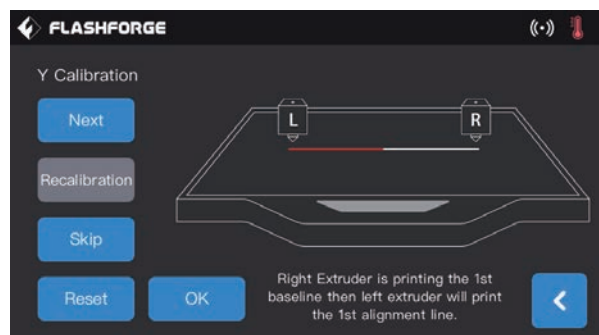
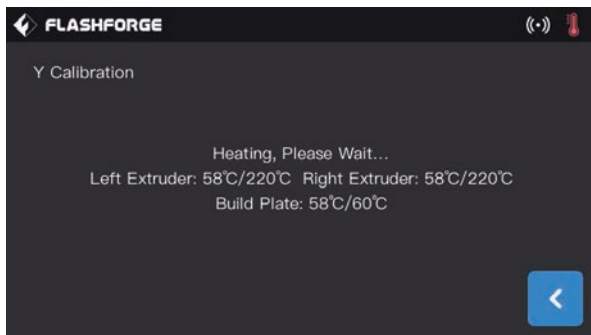

1. Tap [Y axis calibration], wait for two extruders heating up to the target temperature, two extruders print one line in turns. After printing completed, check if two lines coincide; In the meanwhile, a confirmation notice pops up.

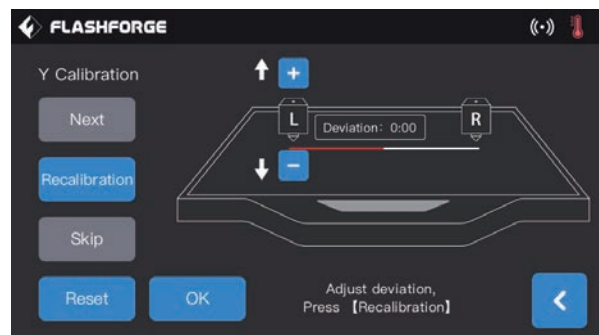
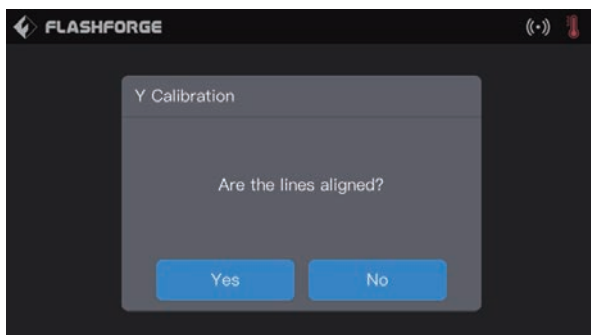

2. If two lines coincide completely, tap [Yes], Y axis calibration completed.

3. If two lines not coincide completely, tap [No], adjust extruder position according to actual situation. After adjustment completed, clean filament on the build plate, tap [Recalibration]; Repeat step 1 and step 2 until two printed lines coincide.

3.5 Internet Connection

• Ethernet connection

Connect your Creator 3 with your PC via Ethernet cable, connection successfully when you see  on the right corner.

• WiFi connection

Tap[Tools]-[Setting]-[WiFi],turn on WiFi to choose your WiFi. Connection successfully when you see  on the right corner.

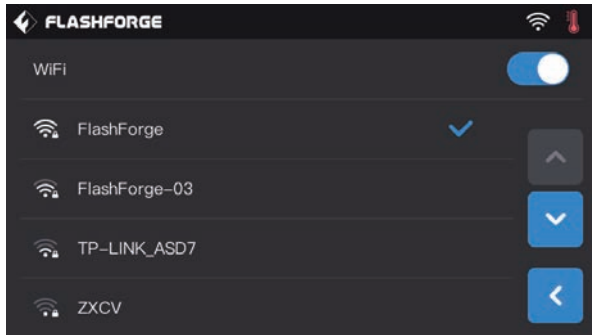

• Hotspot connection

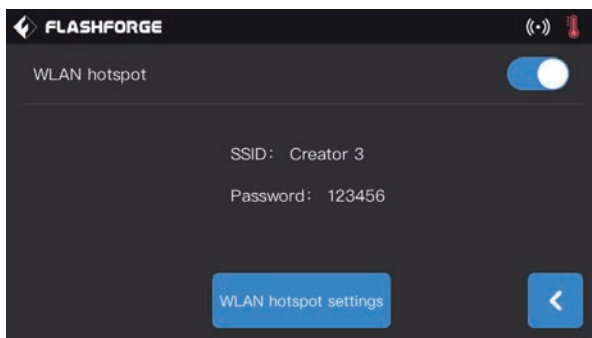

1. Tap[Tools]-[Setting]-[WLAN hotspot] to turn on hotspot.You can set hotspot name and password. Turn on the hotspot successfully when you see  on the right corner.



2. Use laptop to search your hotspot,connect and input password.

Note: If you have more than one printers,enter WLAN hotspot to modify hotspot name separately.

3.6 FlashPrint Software

3.6.1 Software Installation



FlashPrint

1. Software Acquisition

You can choose from two methods to acquire FlashPrint software installation package:

Method 1 : To get the installation package from the USB stick in the toolkit.

Method 2 : Enter FlashForge official website: www.sz3dp.com. Download software version you needed from Support - Support center-Flashprint.

2. Software Installation and Start-up

Open setup and follow instructions to complete installation. Start FlashPrint after installation completed.

3.6.2 Software Interface

Choose machine type of Creator 3 from FlashPrint menu [Print]-[Machine Type], the main screen displays. Interface overview shown as follows:

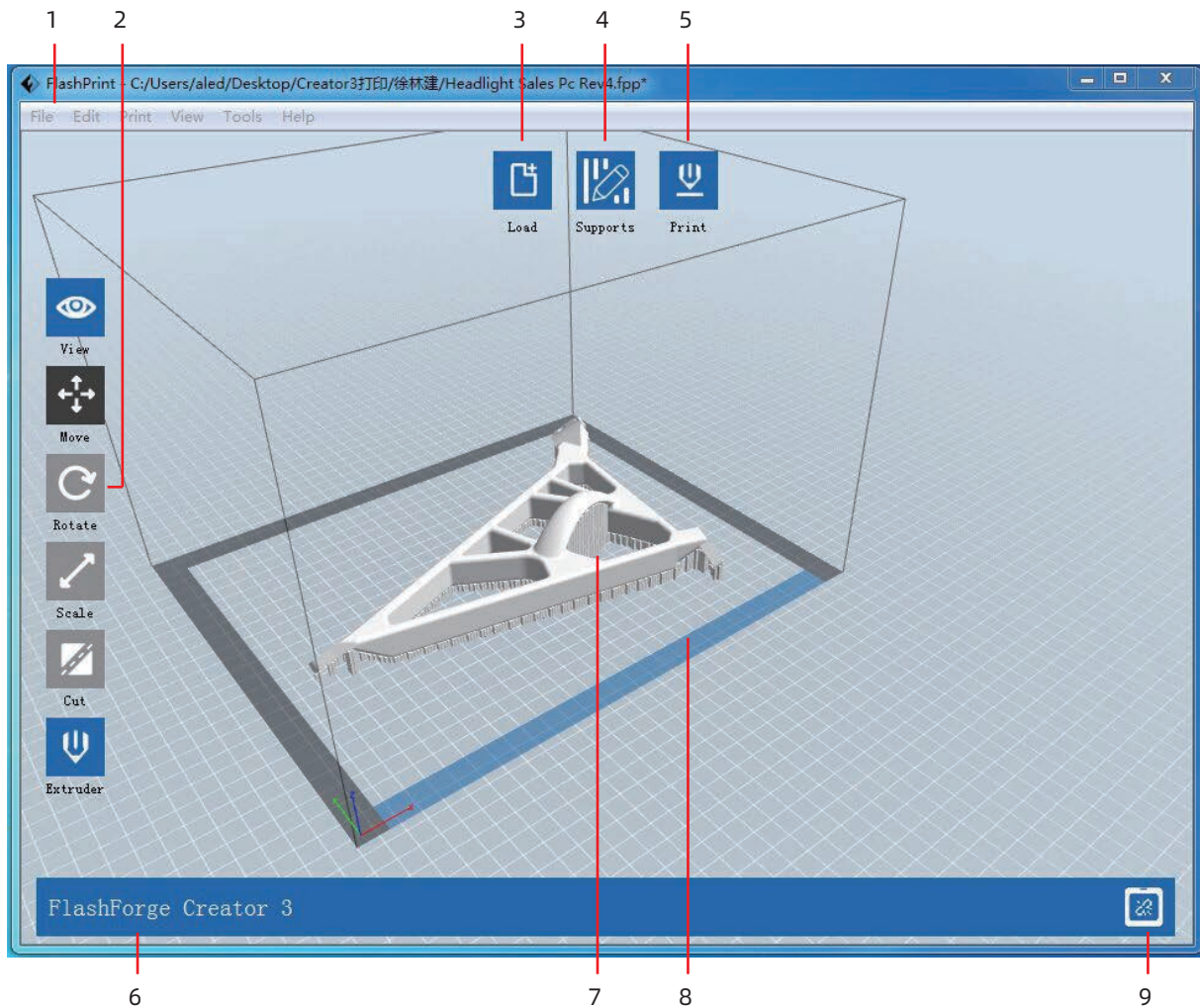

1. Menu bar
6. Printer type

2. Adjust zone
7. 3D models

3. Load model file
8. Build plate front direction

4. Support setting
9. Printer connection status

5. Print

3.6.3 Set Dual Extruder Print

Set left extruder support filament, right extruder structure filament (right extruder as a default) , follow the procedures below:

In expert mode:

1. Load the model;
2. Choose support type, Tap[Supports]>[Supports Options]>[Linear], and check[Touch Platform Only], tap[OK];
3. Auto add supports, tap[Supports]>[Auto Supports], go back and save;
4. Tap[Print], enter the parameter setting page;
5. Regular page, select profile , such as Creator 3 PLA;
6. Regular page, tap[Adapt soluble support filament]>[PVA]>[Adaptable];
7. Tap[Save Configuration]

Click [File]-[Preferences]-[Print]-choose [Expert Mode] you can set the parameters for printing.

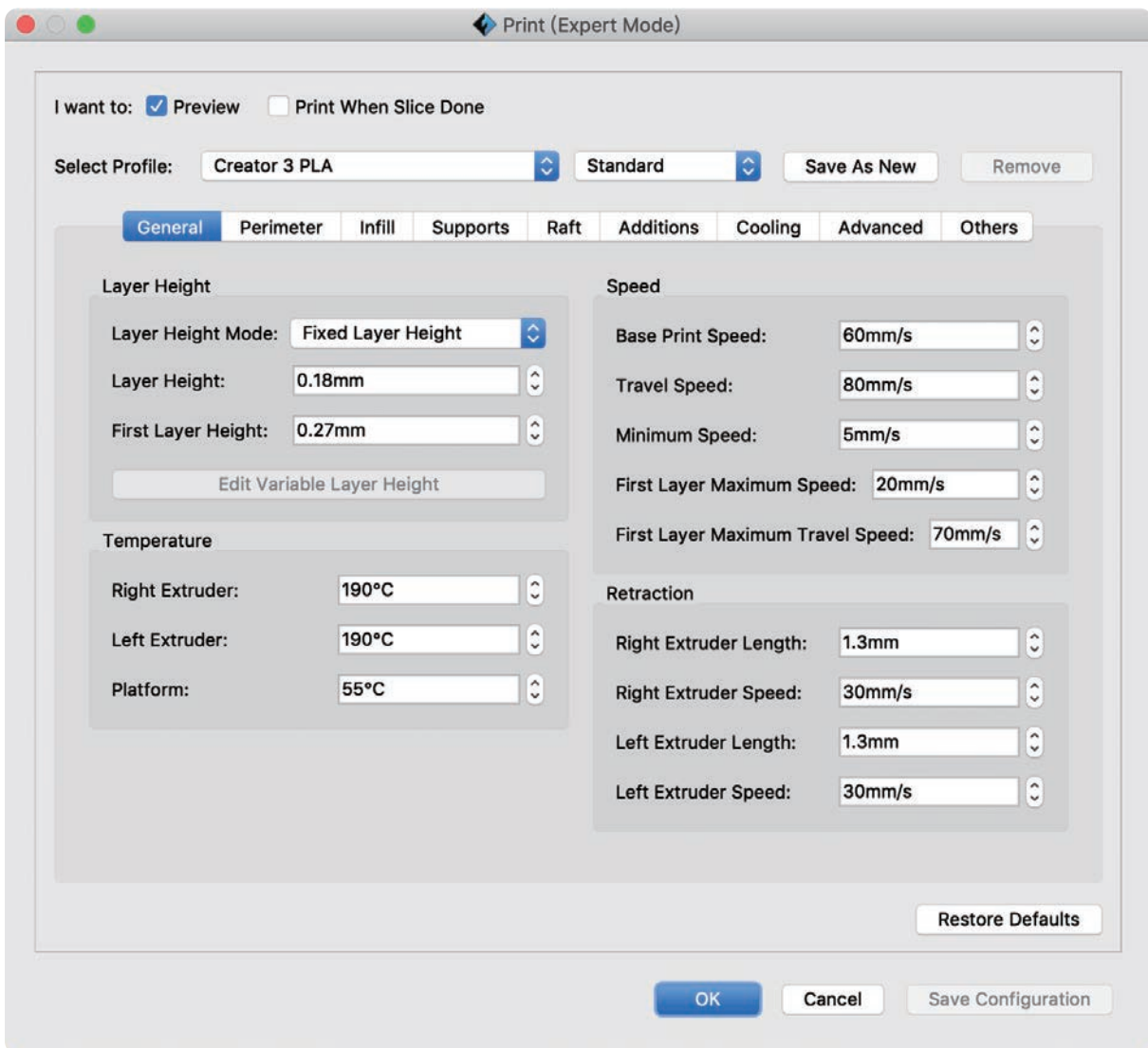

In basic mode:

1. Load the model;
2. Choose support type, Tap[Supports]>[Supports options]>[Linear], and check[Touch Platform Only], tap[OK];
3. Auto add supports, tap[Supports]>[Auto Supports], go back and save;
4. Tap[Print], enter the parameter setting page;
5. Suggest to use structure filament as material right and soluble support filament as material left;
6. Check[Wall] in the resolution, other system default;
7. Tap[Save Configuration]

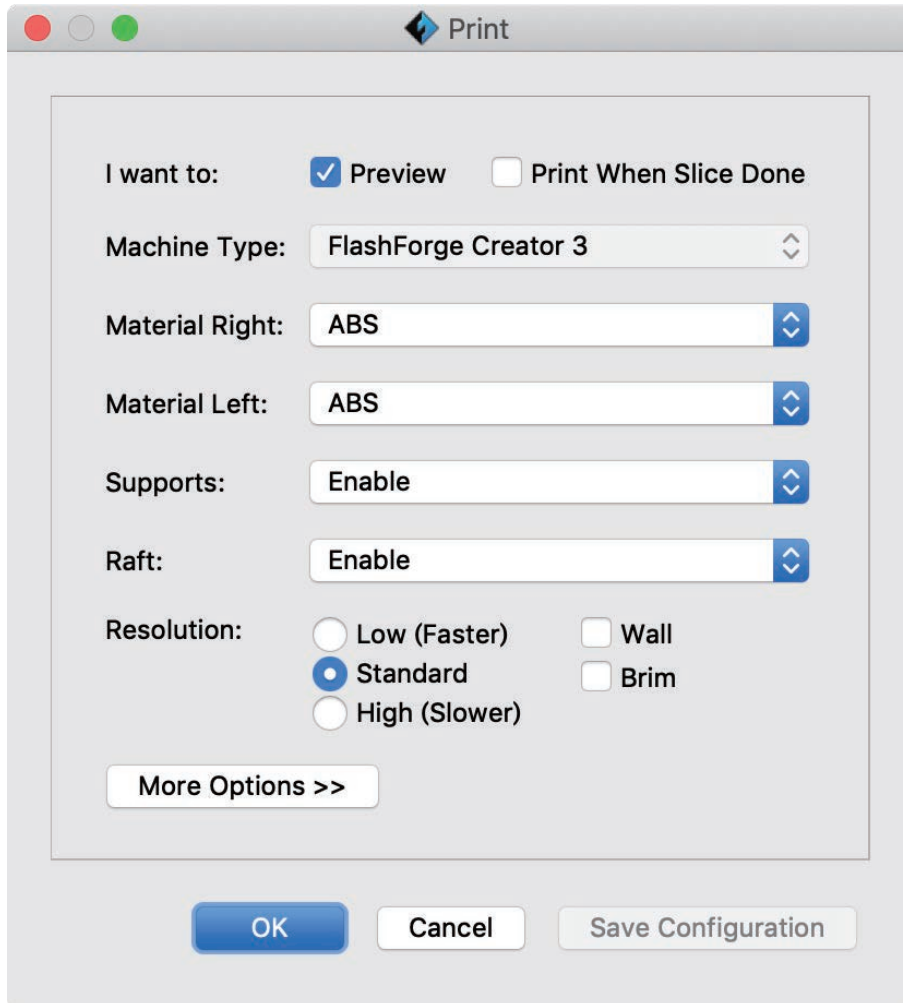

Mirror/ duplicate mode:

If you want to print two same model, please choose the mirror or duplicate mode, the printer will print those two model at same time.

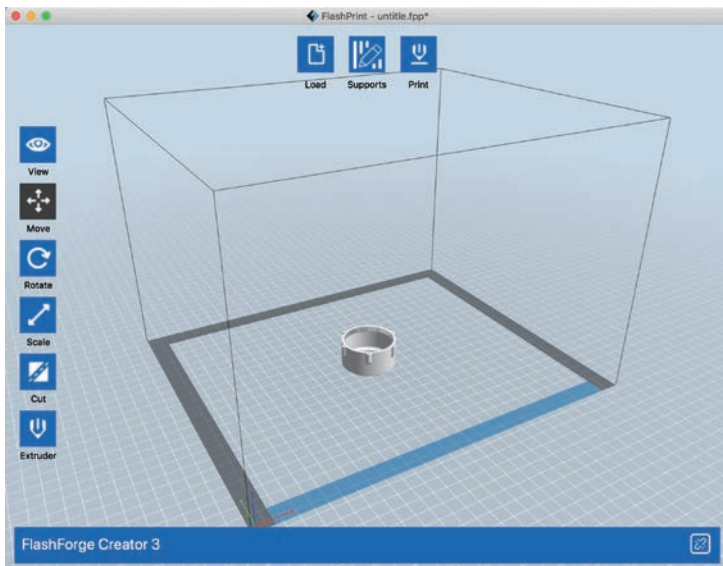

Load the model first, please note the mirror and duplicate support model size is smaller than 133mm (X axis direction)

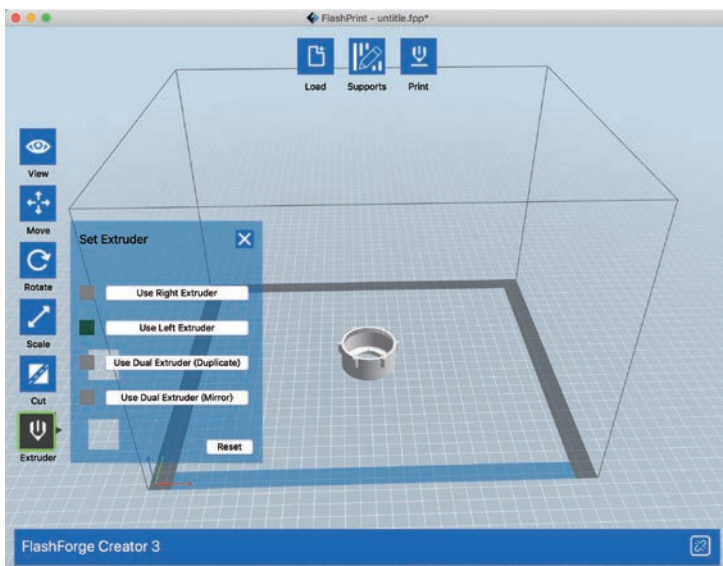

Click [Extruder], choose [Ese Dual Extruder (Dupliacte)] Or [Ese Dual Extruder (Mirror)]

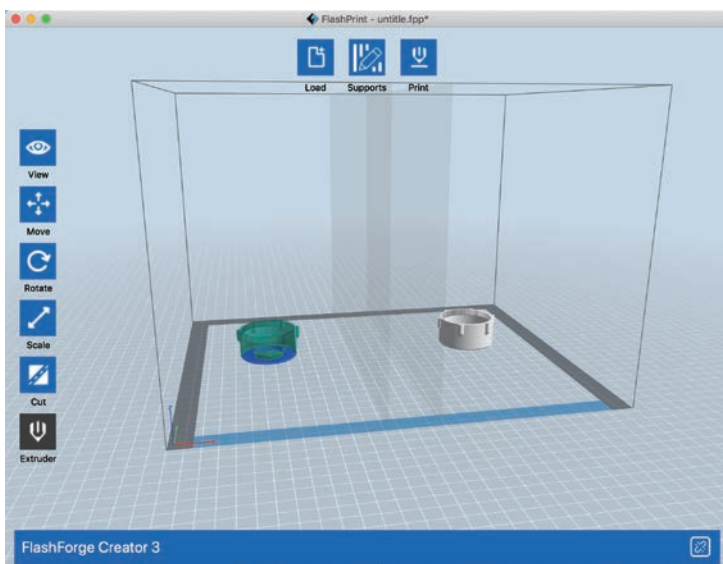

The interface will be show like this.

Notes on mirror and duplicate mode:

Duplicate and mirror mode:

Since the heights of the left and right sprinkler heads are different after installation, the software will automatically add a compensation layer to compensate for the difference in height when slicing, so that the printing heights of the left and right sides are the same. When the z-axis is calibrated, take the right nozzle as the reference and record the height difference of the left and right nozzle.



Left nozzle is lower than right nozzle: right nozzle prints cal pad;
Right nozzle is lower than left nozzle: left nozzle prints cal pad;
The height difference is less than 0.2mm, cal pad will not be printed.
Compensation layer with height difference less than 0.2mm does not print.

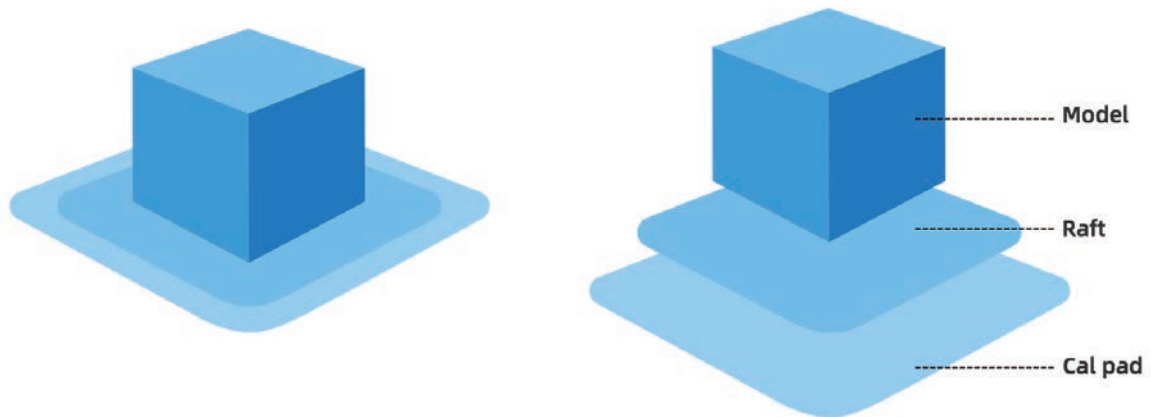

The compensation layer (Cal pad) is printed first. Easy to remove by sticking to the raft. If the raft is not added, the compensation layer directly acts on the model, which is difficult to remove. so we highly recommend to add a raft when choosing mirror or copy mode to print.

4. Operation

4.1 Filament

4.1.1 Filament Compatibility

Creator 3 is equipped with independent dual extruders, which is suitable for PLA,ABS,PETG,Nylon (PA), PC, HIPS and PVA. Independent dual extruder filament combination extrusion situations, see below:

Default left extruder as a support

Dissolvable filament:

Left extruder	Right extruder
PVA	PLA
PVA	NYLON
HIPS	ABS
HIP	ASA
SHIPS	PC
HIPS	PETG
HIPS	HIPS

PVA: Water soluble support filament

HIPS: HIPS can be dissolved in d-Limonene

Insoluble filament combination:

Left extruder	Right extruder
PLA	PLA
ABS	ABS
ASA	ASA
PC	PC
PA	PA
PETG	PETG
PA-CF	PA-CF
PA-GF	PA-GF

Creator 3 is able to print PACF, because of the material of the nozzle is not the hardened, the nozzle will be worn. It's estimated that printing 1-2kg of PACF, will need to change a new nozzle and have to equip with a strong extruder. Standard device equipped with a standard feeding extruder.

While Creator 3 is adopted with open type filament system, we still suggest using Flashforge filament. All the Flashforge filament is tested professionally, and are possessed of optimized configuration files, which ensures perfect print effect.

Storage of PVA /PA

Direct exposure to the air, it is easy subject to moisture and softening, print bad easily after softening, so please store the PVA in dry box when printing. It should be stored in sealed bag or dry box.

4.1.2 Print Setting

Each type of filament needs different setting for best print effect.

If using prepared models of Flashprint, setting completed automatically under the circumstance of choosing correct extruder and filament.

For better adhesiveness of print product, we suggest applying a thin layer of glue (Use the glue stick in the accessory box) before printing.

Adaptability of filament parameters

Different filament brands have different filament characteristics. When using creator 3, it is recommended to use expert mode to find a suitable parameter to ensure better printing quality.

- Thickening and increase flow rate of the first layer are beneficial to the adhesion.
- When printing small models (or environment temp is higher than 25 degree) with PLA: suggest to set platform temperature to 45 degrees.
- When printing big models (or environment temp is lower than 10 degree) with PLA: suggest to set platform temperature to 70 degrees.
- Print PVA as support, suggest to set speed to 40%.

4.2 Print Start-up

Please complete the leveling, loading and calibration correctly with the guidance of User Guide at first print.

- **Print from internal memory card**

Tap[Tools]-memory card icon on the touch screen, choose printed files saved in internal memory card already. The print file copy by this method is not supported.

- **Print form USB stick**

Tap[Tools]-USB stick icon on the touch screen, choose printed files saved in USB stick already. Support to copy the print file to device internal memory card.

- **Print from Network Transmission**

The network transmission printing method is limited to the device and the computer within the same LAN, regardless of the use of wired network connection or wireless network connection.

1. Refer to page 22 Internet connection to connect successfully.

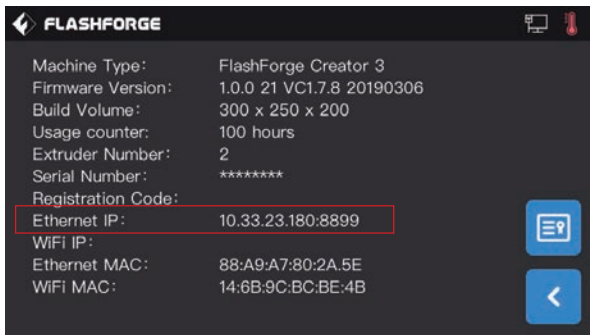

2. Tap[Tools]-[About] in turns on the touch screen, check and record Ethernet IP address:10.33.23.180(The example is for reference only, with the local IP address as the criterion.).

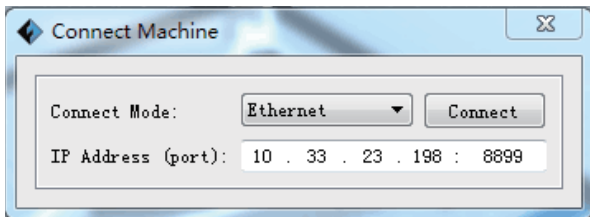

3. Tap FlashPrint menu bar in turns [Print]-[Connect machine], choose[Ethernet]connection, input:10.33.23.180:8080(The example is for reference only, with the local IP address as the criterion).

After connecting successfully, you will see  on the bottom right corner.

• **Print from hotspot connection**

1.Refer to Page 22 hotspot connection to connect successfully.

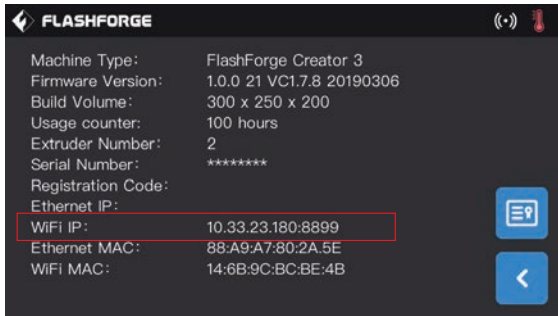

2.Tap[Tools]-[About] in turns on the touch screen, check and record WiFi IP address:10.33.23.180(The example is for reference only, with the local IP address as the criterion.)

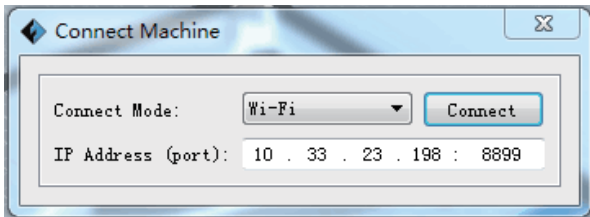

3.Tap FlashPrint menu bar in turns [print]-[connect machine],choose[Wi-Fi]connection,input:10.33.23.180:8080(The example is for reference only, with the local IP address as the criterion).

After connecting successfully, you will see  on the bottom right corner.

• **Print from FlashCloud**

1. Turn on WiFi or Ethernet to connect the internet.
2. Tap[Tools]-[Setting]to turn on FlashCloud.
3. Enter FlashCloud website: <http://cloud.sz3dp.com> to operate:

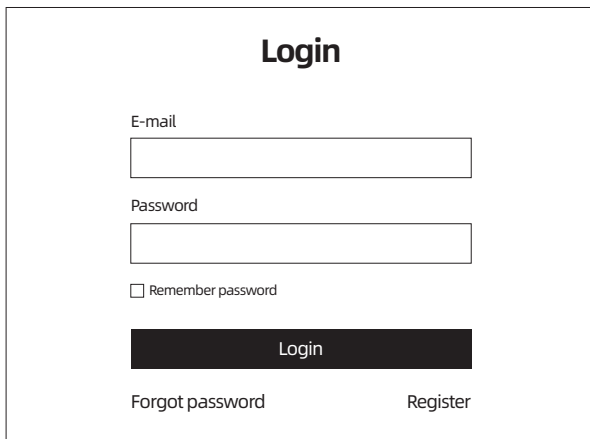

① Register FlashCloud account and login in on FlashCloud website: <http://cloud.sz3dp.com>.

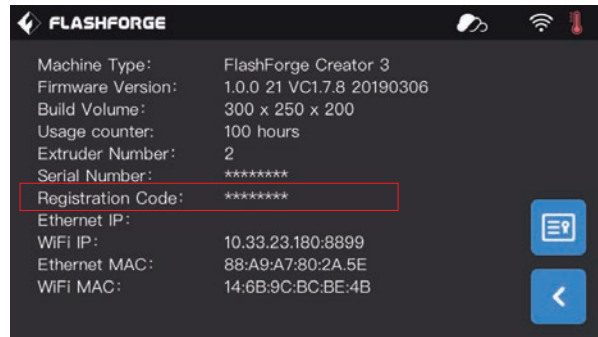
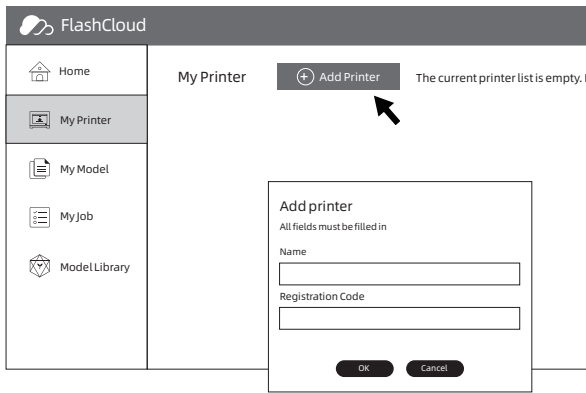

② Tap[Add Printer] on[My Printer],fill in printer name and registration code.(after turning on FlashCloud, check registration code on [Tools]-[About]).

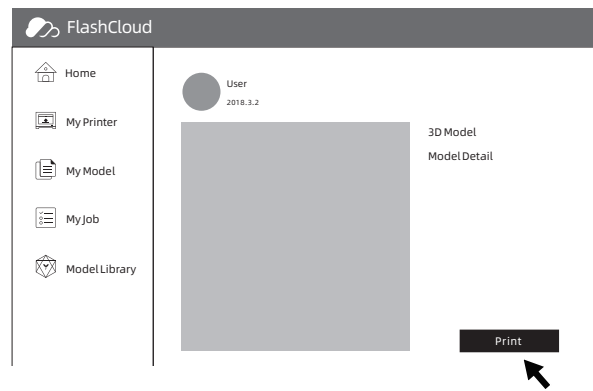
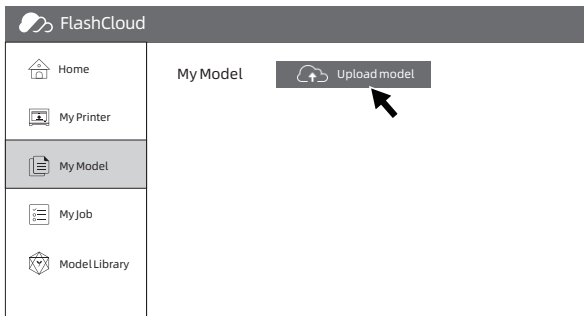

4. Choose one model from model library or upload your STL.file,tap[Print] to enter simple model edit interface.

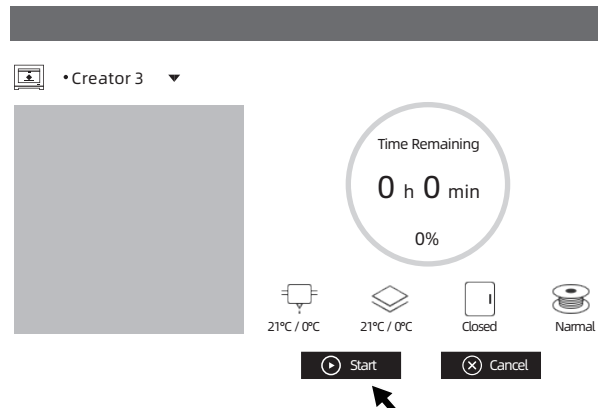
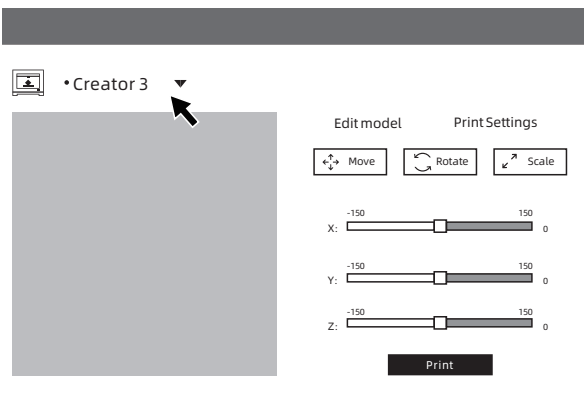

5. Choose the printer to do print job from pull-down menu.(The printer must be added to my printer)

6. Tap[Start],the printer starts to print.

Note: For security reason,on printer is used for one FlashCloud only, if you need to change FlashCloud account, please delete this machine with the original account.

4.3 Model Removal

Warning! Be careful of your body position when using manual tool to remove the model from build plate. Sudden tool slippage and improper body position may cause injury.

Caution: Do not scratch build plate when removing the model. Scratches in build plate will cause modeling errors.

· Model cooling

Let build plate and model cool down themselves when printing without using glue stick, you can remove model easily from build plate.

· Use scraper

Remove model with a scraper when model still attached to the build plate after cooling. Keep the scraper parallel to build plate, and insert it into model bottom, you can remove model successfully.

If necessary, remove build plate from the printer, then remove model from build plate with a scraper.

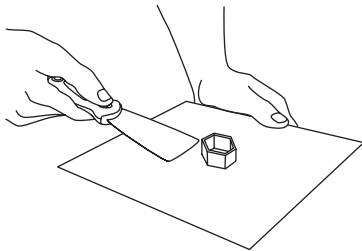

· Use water

If glue stick is used when printing, and neither of above methods is effective, wash build plate with warm water to dissolve the glue after taking build plate from the printer.

The model can be removed easily after glue dissolved. If PVA is used, immerse build plate and model into water to dissolve PVA to remove the model.

4.4 Support Removal

When PVA used as support material, we suggest doing follow-up processing by immersing PVA into water to remove support.

1. Immerse model into water

Put models with PVA into water to dissolve PVA. The following methods of accelerating dissolution:

- Use hotter water to reduce dissolution time. If PLA is used as structure filament, make sure that the highest water temperature will not exceed 35° to avoid PLA deforming; if is nylon, the highest water temperature will not exceed 50° to avoid burning.
- Stir water to reduce dissolution time, PVA dissolves faster in running water.
- Immerse model in the water for 10 minutes, then use pliers to remove most of support and put model in the water again, thus PVA dissolving faster.

2. Wash with water

Wash residual PVA with water after PVA completely dissolved.

3. Dry the model

Dry model completely. Do extra post-processing of model if necessary.

4. Wastewater treatment

Wastewater is easily cleaned because of PVA biodegradability. When the waste water pipeline is connected to the waste water treatment plant, the waste water can be discharged through the waste water pipeline. After disposal of wastewater, flush it with hot water for 30 seconds to remove excess PVA in the drainage pipe to avoid long-term blockage.

Water is available for repeated use, but immersing multiple models may increase dissolution time, we suggest using new water in order to reach best effect.

4.5 Camera Connection

Remove the front cover of camera before using camera.

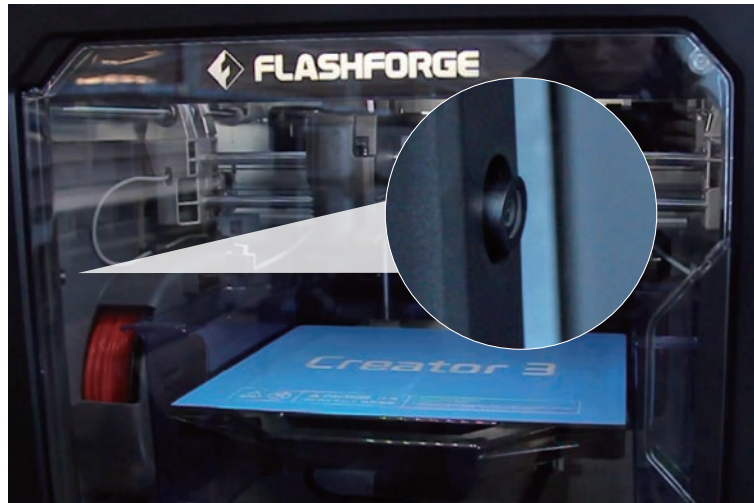

· WLAN hotspot connecting camera

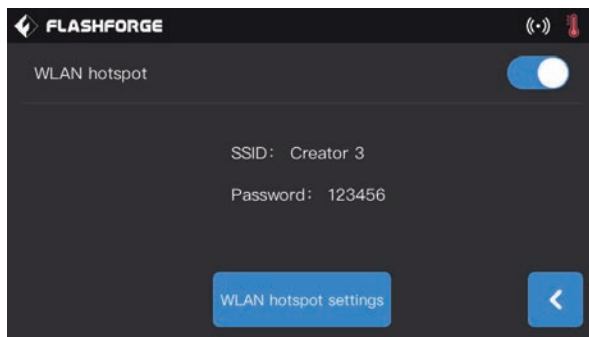

1. Refer to page 22 hotspot connection to connect successfully.

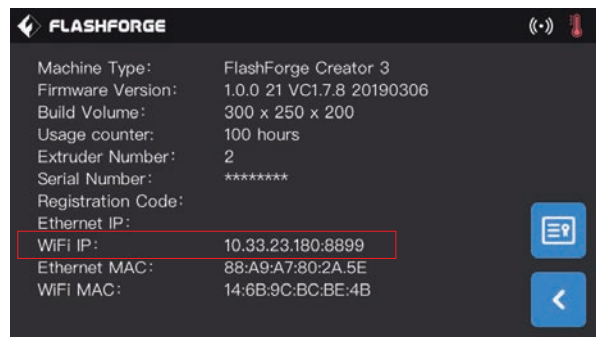

2. Tap [Tools]-[Setting]-[About] in turns on the touch screen, check and record WiFi IP address:10.33.23.180(The example is for reference only, with the local IP address as the criterion.)



3. The computer successfully connected to WLAN hotspot within the same LAN.

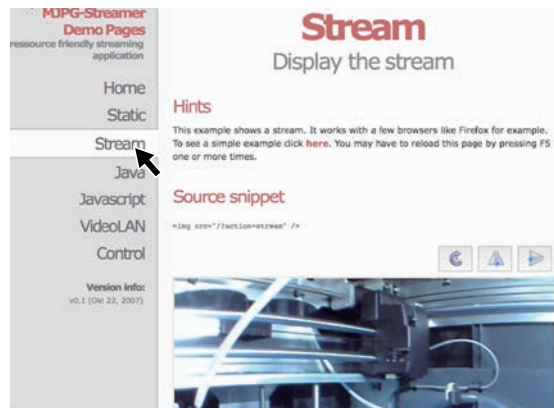

4. Input and enter address: 10.33.23.180:8080(The example is for reference only, with the local IP address as the criterion)., Tap [Stream] to check Creator 3 camera.

Note: The result is all same to use computer,mobile phone,iPad to turn on [Stream].

· WLAN WiFi connecting camera

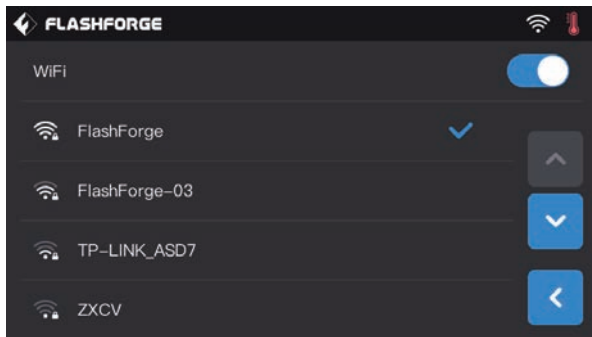

1. Tap[Tool]-[Setting]-[WiFi] in turns on the touch screen,turn on WLAN button to connect the network.

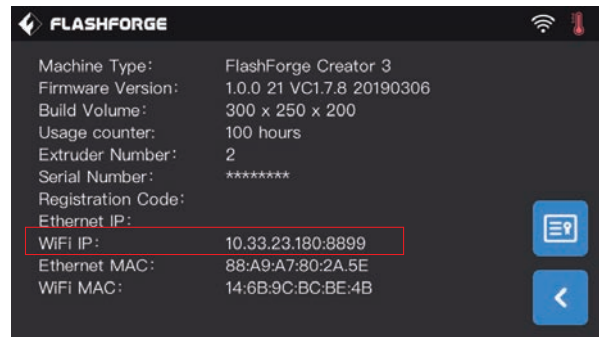

2. Tap[Tools]-[Setting]-[About],check and record WIFI IP address: 10.33.23.180(The example is for reference only, with the local IP address as the criterion).

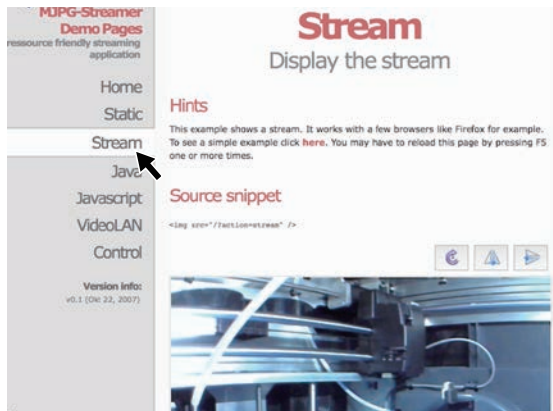

3. Input and enter address: 10.33.23.180:8080(The example is for reference only, with the local IP address as the criterion)., Tap[Stream]to check Creator 3 camera.

Note: The result is all same to use computer,mobile phone,iPad to turn on [Stream].

· FlashCloud connection camera

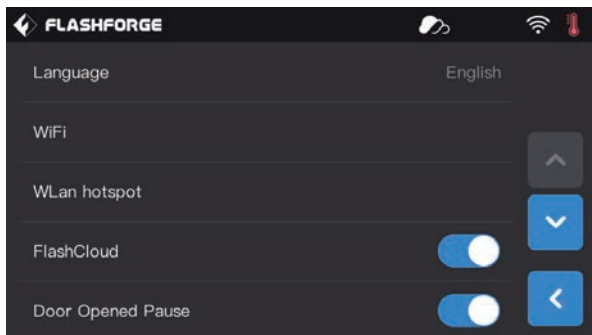

1. Turn on WiFi or plug in Ethernet cable to connect the network.
2. Tap[Tools]-[Setting] in turns to turn on FlashCloud switch.

Login

E-mail

Password

Remember password

Login

[Forgot password](#) [Register](#)

3. Register FlashCloud account and login in on FlashCloud website: <http://cloud.sz3dp.com>

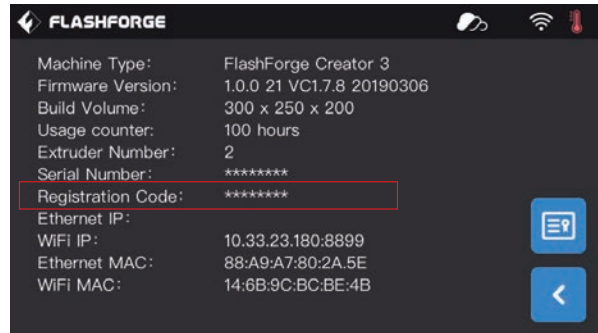
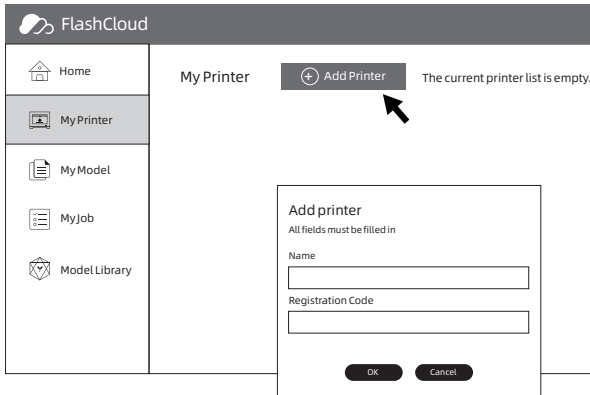

4. Tap [Add Printer] on [My Printer], fill in printer name and registration code. (after turning on FlashCloud, check registration code on [Tools]-[About]).



5. Choose your printer to enter printer detail page.

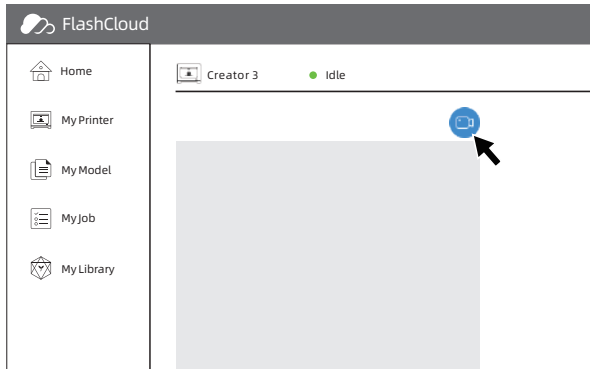

6. Tap camera icon indicated by the arrow, camera starts to work.

Note: Make sure printer has connected to network successfully, FlashCloud function is turned on and printer is on camera-on status.

5. Introduction of Touch Screen

5.1 Print

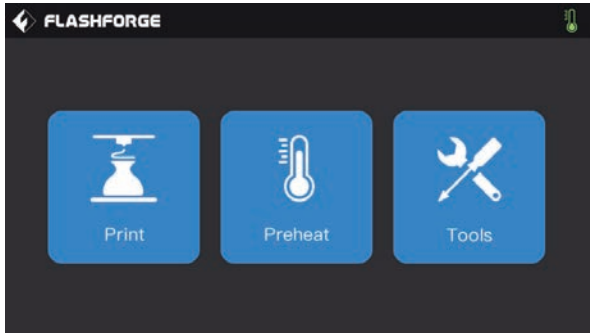

Tap[Print],choose your model.

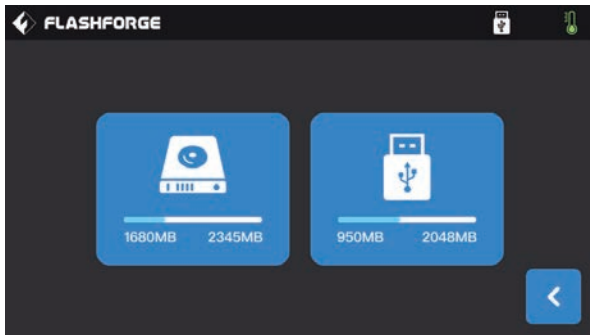

Choose methods to read print files:

1. Read from printer local memory card
2. Read from USB stick.



Select the target print file among the list

1. **Build:** To begin printing.
2. **Copy:** To copy the files to the local memory card from the USB stick. (The button is not available while printing from local memory card)
3. **Delete:** To delete the print file.

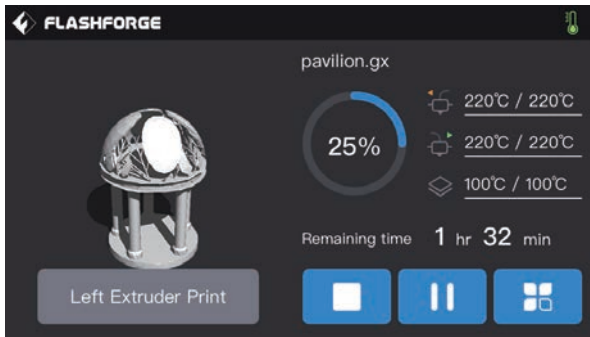

Print interface

1. **Abort:** To abort the print job.
2. **Pause/Resume:** To suspend or resume the print job.
3. **More:** Real-time check or change: filament setting, lights-off setting, print speed, print schedule, filament usage, print time and Z-axis coordinate
4. **Left/Right Extruder temperature, build plate temperature:**
Can be modified during printing.

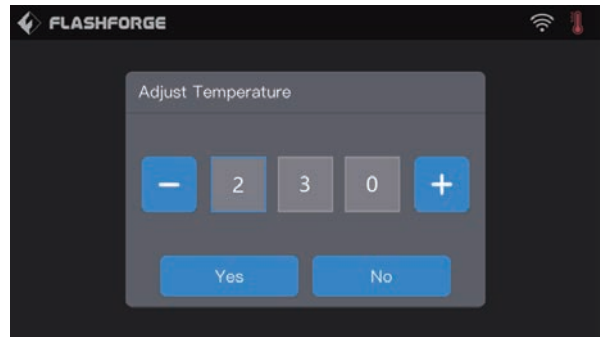

To modify left/right Extruder and baseboard temperature:

After temperature has reached target temperature, temperature figure will be underlined in print interface, choose number box, modify extruder temperature by tapping '-' '+'. Tap [Yes] to save the setting while tap [No] to cancel the setting.

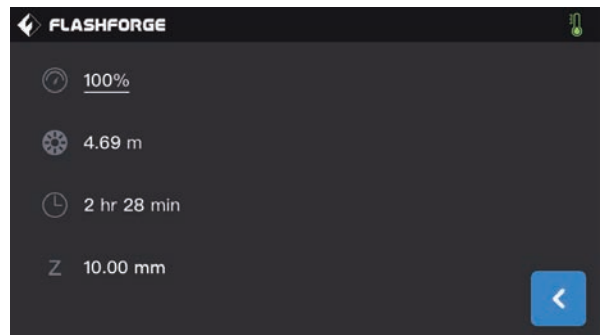
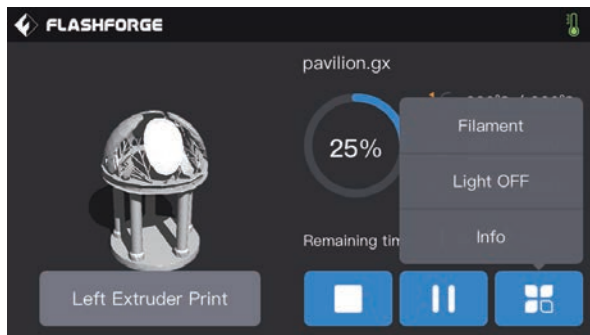

Tap more buttons during printing

Real-time check or change: filament setting, light-off setting, print details (print speed, filament use, print time, Z-axis coordinate)

1. **Filament changing:** Tap [Filament] to change filament during printing. (This function works after pausing printing).
2. **Turn off the light:** Tap [Light off] to turn off the lights during printing.
3. **Details:**
 - a) **Print speed:** To set print speed value during printing.
 - b) **Filament use:** Check filament usage amount. (m)
 - c) **Print time:** Check print time
 - d) **Z-axis:** Check Z-axis coordinate
 - e) **Back:** Cancel tool instructions, go back to print interface.

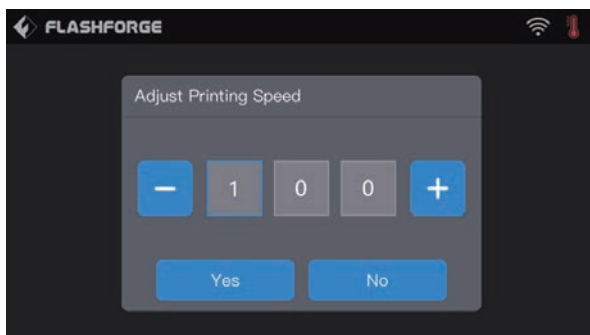

To set extruder printing speed during printing

To set the printing speed during printing: Tap [Yes] to save the setting while tap [No] to cancel the setting.

5.2 Preheat

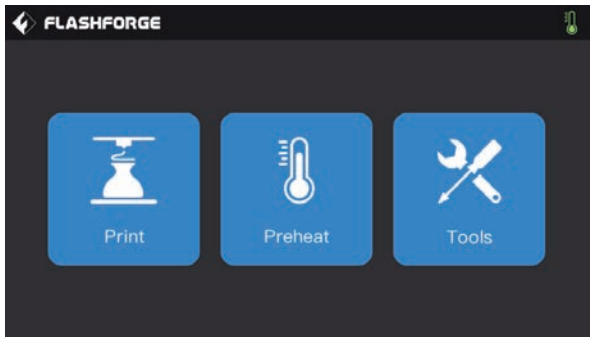

Tap[Preheat],enter preheat interface.

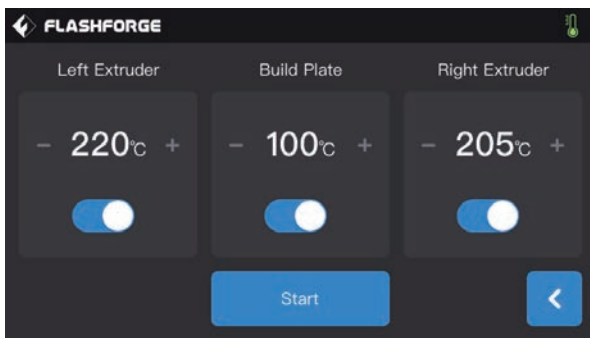

Preheat interface:

1. **Turn on/off:** turn on left/right build plate preheating function, turn off left/right build plate preheating function.
2. **Temperature value:** tap '-' '+'temperature value to set preheating temperature.
3. **Start:** tap[Start],extruder or build plate starts to preheat.

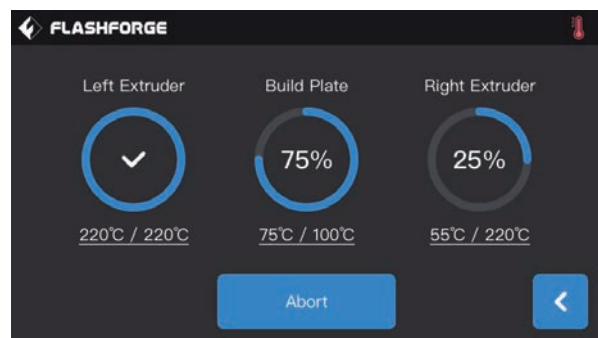

Extruder/build plate heating interface:

1. **Actual temperature value;**
2. **Target temperature value;**
3. **Stop:** stop to preheat;

5.3 Tools

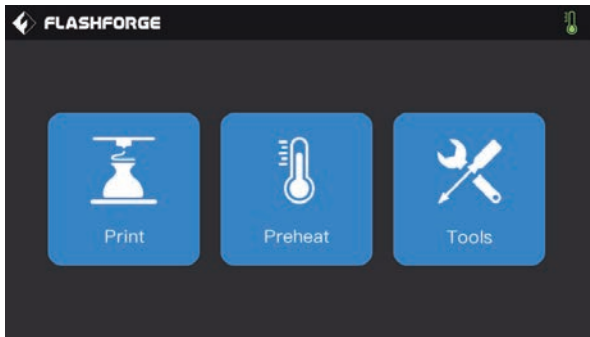

Tap[Tools] to enter tools setting interface.

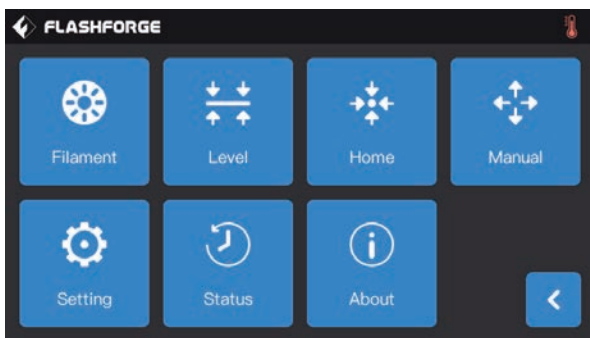

Tools interface

1. **Filament change:** loading/unloading operation;
2. **Leveling:** level build plate;
3. **Zero returning:** to make printer X/Y/Z-axis go back to zero;
4. **Manual adjusting:** Manual adjust the position of X/Y/Z-axis;
5. **Setting:** Related functions setting;
6. **State:** Check printer real-time state;
7. **About:** Check printer version information;

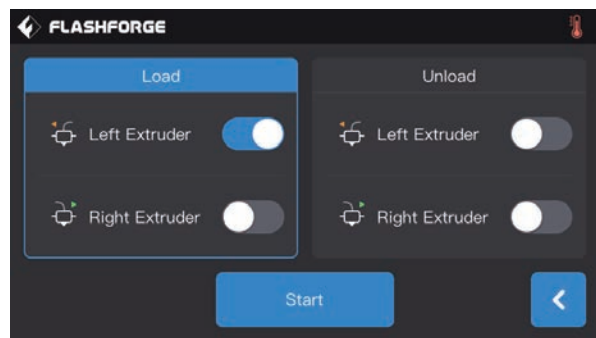

[Tools]-[Filament]

Loading/unloading interface:

1. Loading interface;
2. Unloading interface;
3. Left extruder loading button;
4. Right extruder loading button;
5. Left extruder unloading button;
6. Right extruder unloading button;
7. Start: Tap[start],loading/unloading starts.

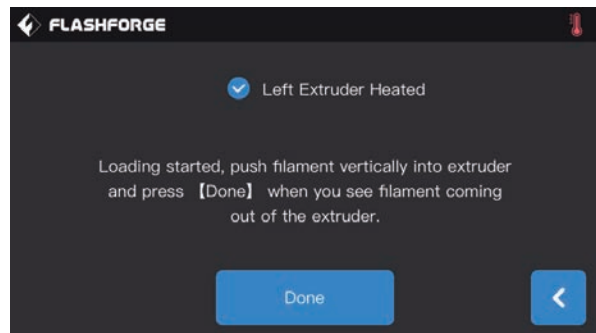
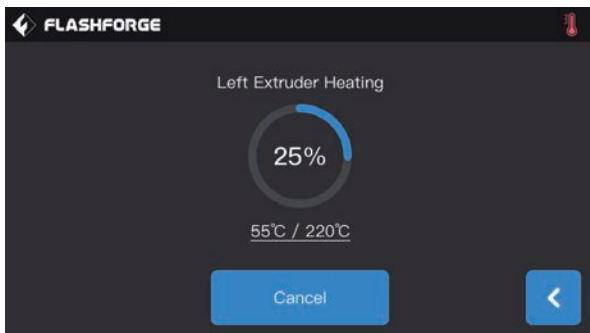

Loading/Unloading operating interface:

- a. Actual temperature value;
- b. Target temperature value;
- c. Abort, to cancel preheating;
- d. Completion: Operating by interface instructions;

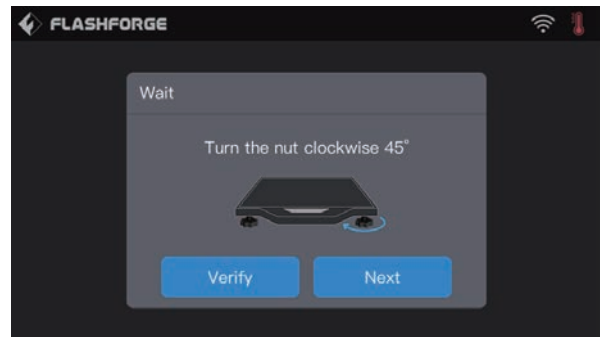
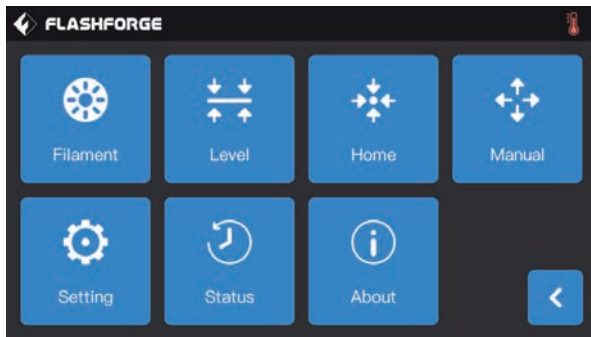

[Tools]-[Level]

Tap[Level],build plate starts.(more details refer to page 13)Touch screen shows instructions, tell you how to adjust build plate.

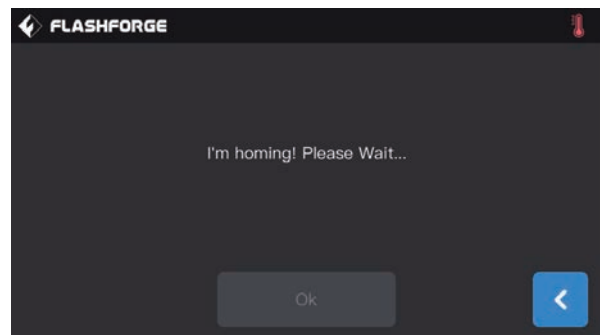
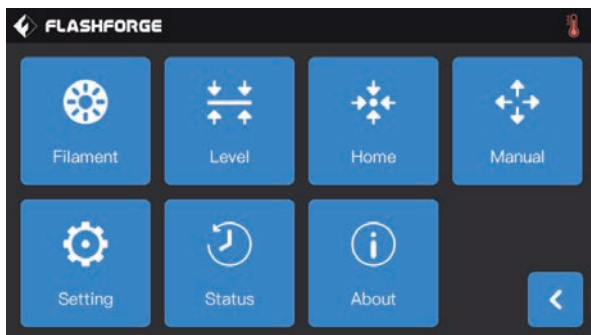

[Tools]-[Home]

Tap[Home],extruder and build plate go back to zero.

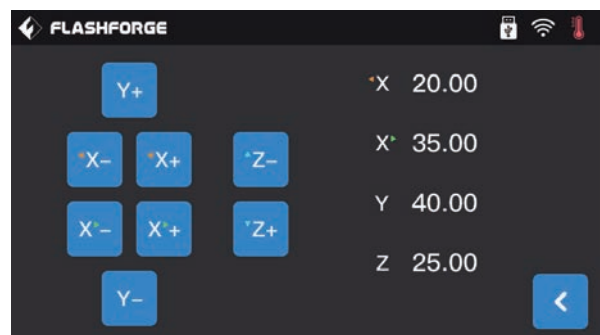
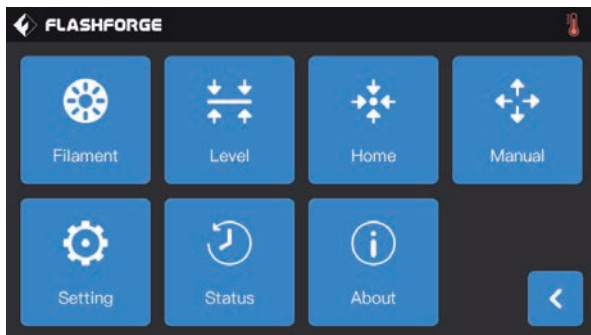

[Tools]-[Manual]

Tap[Manual],enter manual adjustment mode:

1. **Y+**: The extruder moves to the zero point, that is, the back of the machine;
2. **Y-**: The extruder moves to the direction opposite to the Y+;
3. **X-**: The left extruder moves to the zero points, that is, to the right direction;
4. **X+**: The left extruder moves to the direction opposite to the X+;
5. **X-**: The right extruder moves to the zero points, that is, to the left direction;
6. **X+**: The right extruder moves to the direction opposite to the X+;
7. **Z-**: The build plate descends;
8. **Z+**: The build plate elevates.

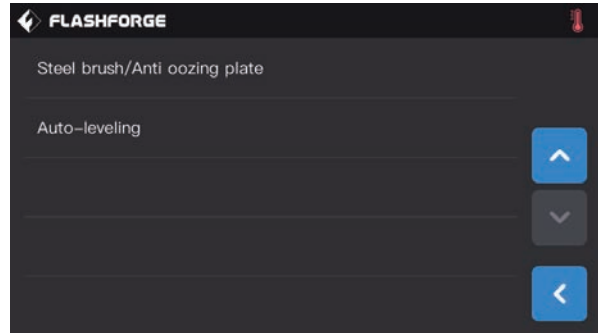
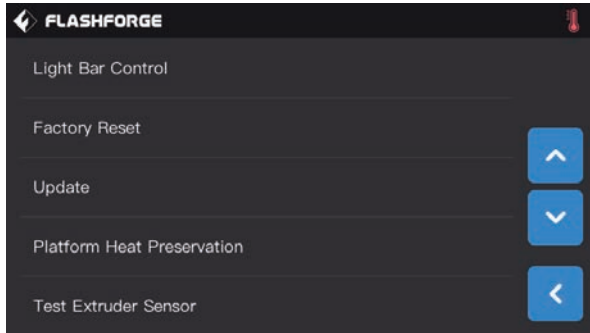
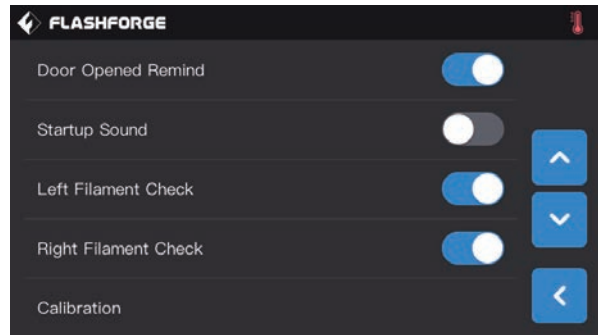
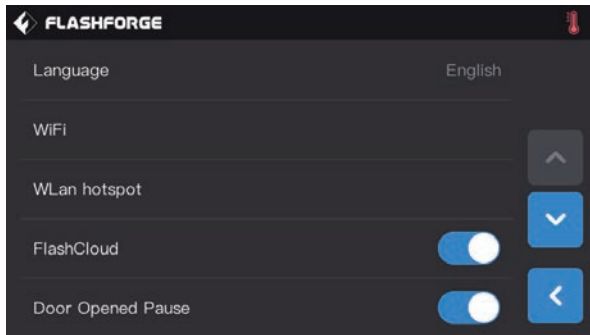

[Tools]-[Setting]

Tap [setting] to enter setting interface

1. **Language:** To set the display language;
2. **Wi-Fi:** To turn on/off the Wi-Fi;
3. **WLAN hotspot:** To turn on/off the WLAN hotspot;
4. **FlashCloud:** turn off/on Cloud connection;
5. **Door Opened Pause:** To turn on/off the Door Opened Pause;
6. **Door Opened Remind:** To turn on/off the Door Opened Remind;
7. **Startup Sound:** To turn on/off the startup Sound;
8. **Left Filament Check:** To turn on/off the filament check on left extruder;
9. **Right Filament Check:** To turn on/off the filament check on right extruder;
10. **Calibration:** To adjust the initial distance between the extruder and the build plate;
11. **Light Bar Control:** To turn on/off the light bar control;
12. **Factory Reset:** Return to factory setting;
13. **Update:** To update the firmware version;
14. **Platform Heat Preservation:** When the printing finished, the platform will keep heating the current setting time;
15. **Test Extruder Sensor:** The detection function of extruder sensor is able to detect whether the sensor is abnormal;
16. **Steel Brush /Anti oozing plate:** Support two type plate.
17. **Auto-leveling:** Turn on this function, the compensation value will be application during printing.

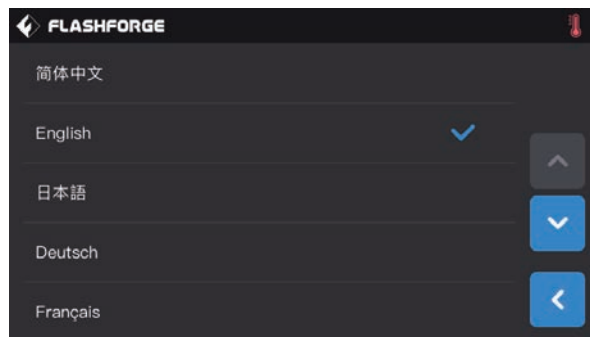
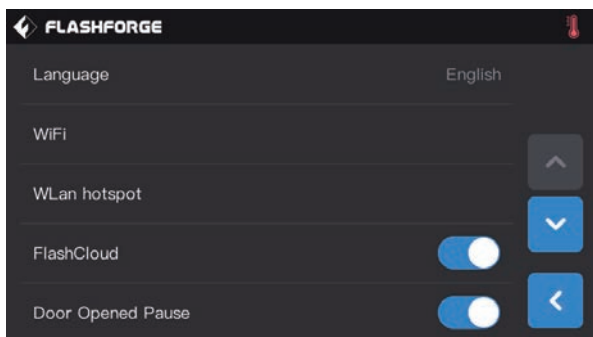

[Setting]-[language]

Tap [language] to enter language setting interface

1. Tap to choose the display language.
2. Page turning: Turn to the up/down menu.

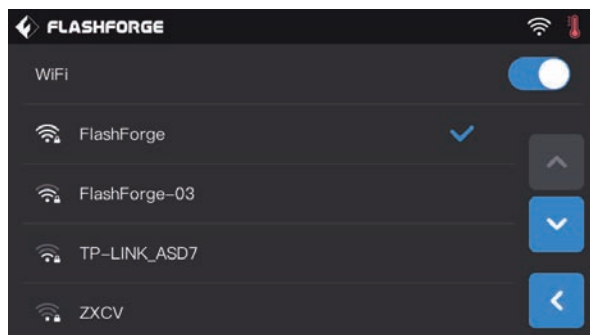
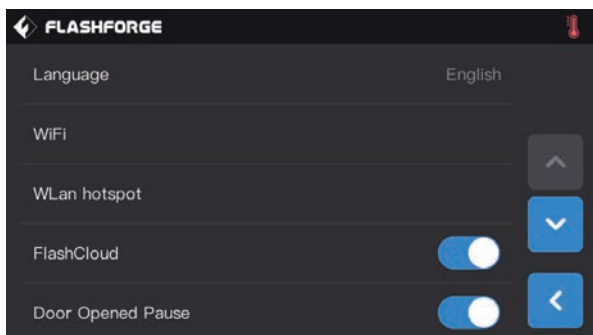

[Setting]-[WiFi]

Turn on WiFi function, the device can connect to network:

1. Remote file transfer and print. For details, see page 29 network transfer print.
2. Remote control device print state, for details, see page 34 WiFi connection camera.

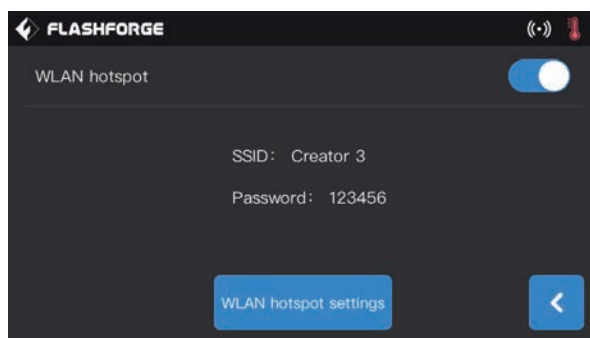
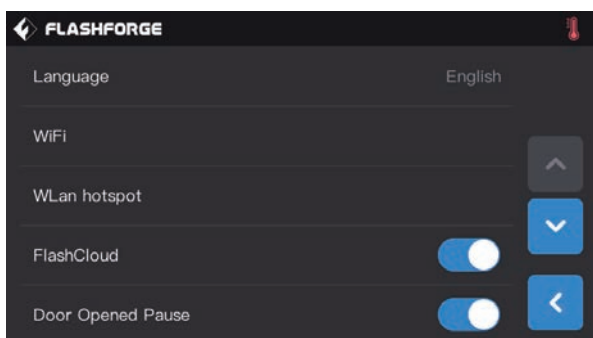

[Setting]-[WLAN hotspot]

Turn on WLAN hot-spot function, the device can connect to PC hot-spot:

1. Remote file transfer and print, for details, see page 30 hotspot connection print.
2. Remote control device print state, for details, see page 33 WLAN hotspot connection camera.

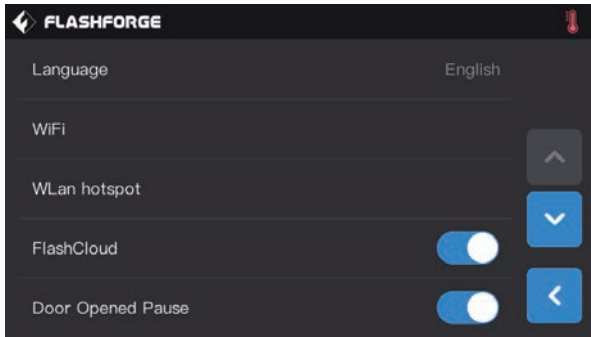

[Setting]-[FlashCloud]

Via FlashCloud, users break network restrictions:
 1. Remote file transfer and print, for details, see page 30 Flash Cloud print.
 2. Remote control device print state, for details, see page 34 Flash Cloud connection camera.

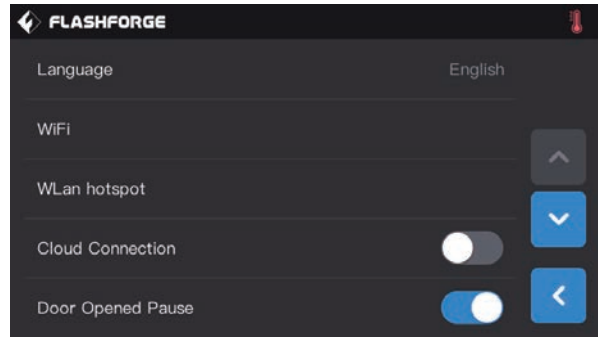

[Setting]-[Door Opened Pause]

After this function is turned on, print will stop when door is opened during printing.

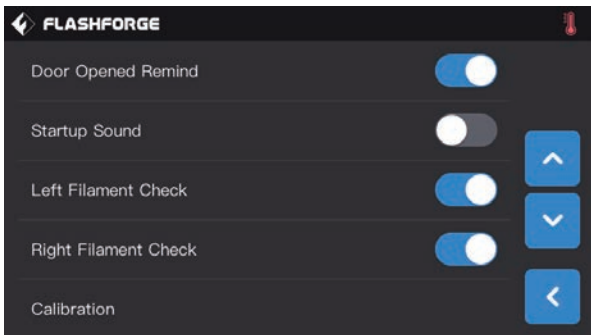

[Setting]-[Door Opened Remind]

After this function is turned on, Door opened note will pop out when door is opened during printing.

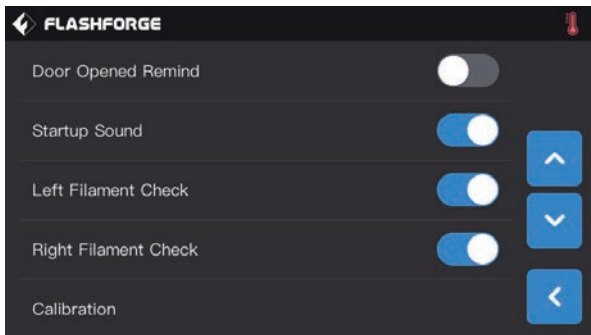
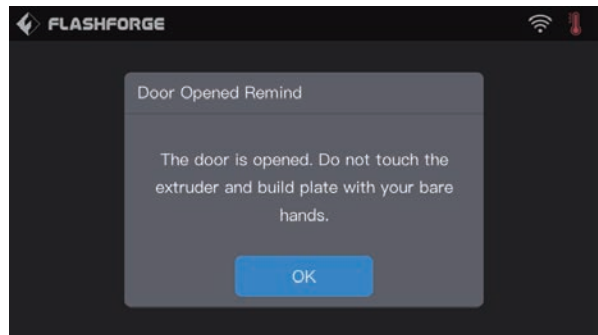

[Setting]-[Startup Sound]

Tap to turn on/off the sound when restart the printer.

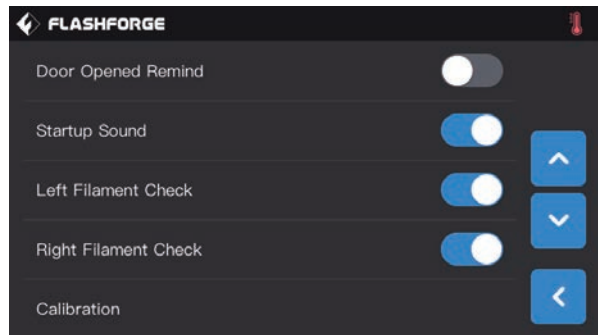

[Setting]-[Left/Right Filament Check]

Tap to turn on/off right/left filament check. After this function is turned on, the print will be detected when filament used up or print breaking off; Turn off this function when using external filament, ensure print successfully.

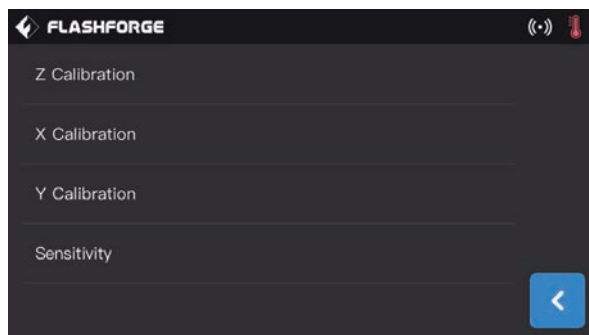
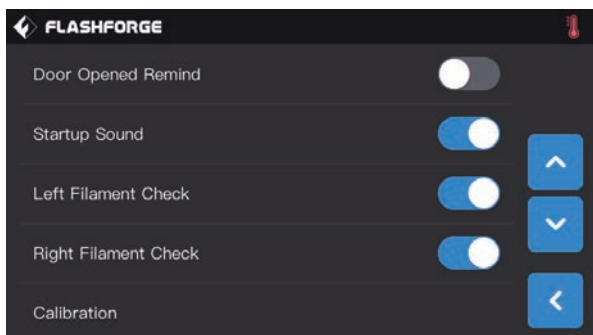

[Setting]-[Calibration]

Calibration includes Z axis calibration, Y axis calibration and X axis calibration. For details see Page 19.

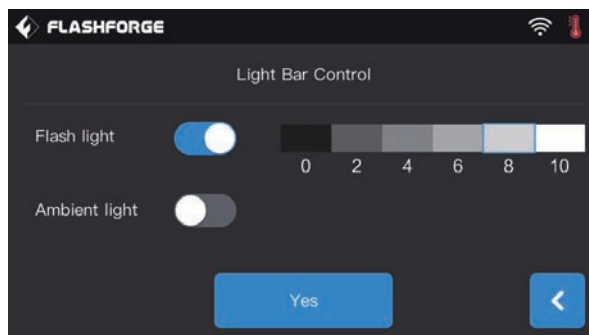
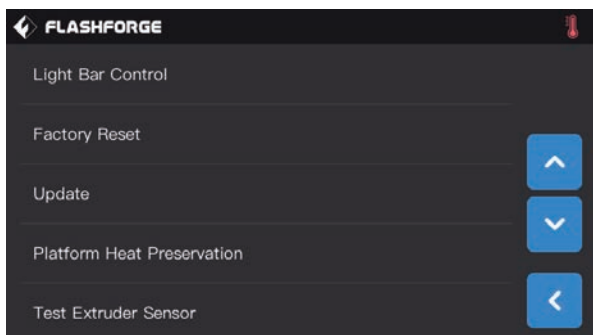

[Setting]-[Light Bar Control]

Turn on or off flash/ ambient light; light brightness can be adjusted according to your demands.

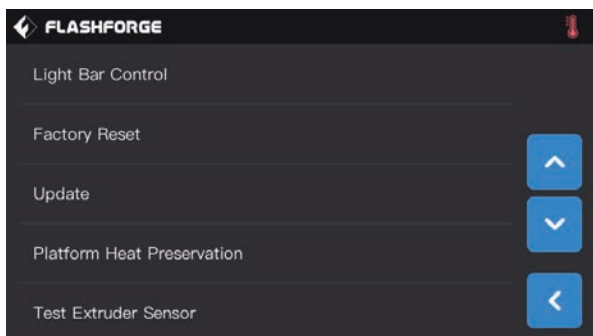

[Setting]-[Factory Reset]

Turn on this function, the device state restored to the factory fault setting.

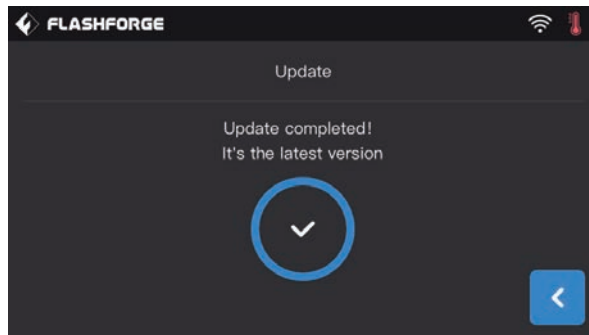
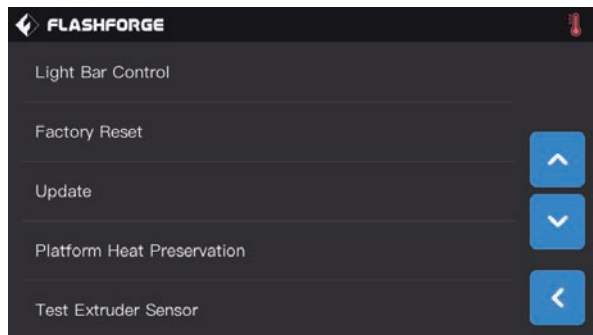

[Setting]-[Update]

Tap [update] when device connected to WLAN network. The device will update to the latest version automatically when needed. Reboot the device after update completed.

Note: Do not cut off power and network, or printing fails.

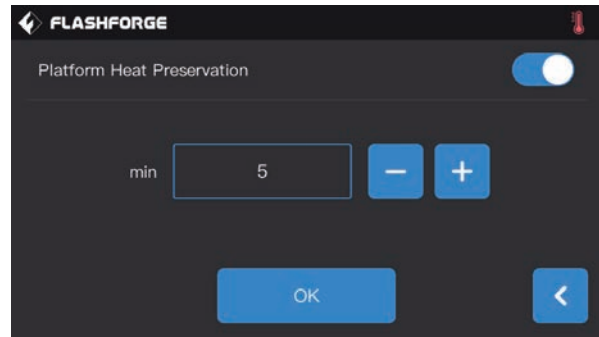
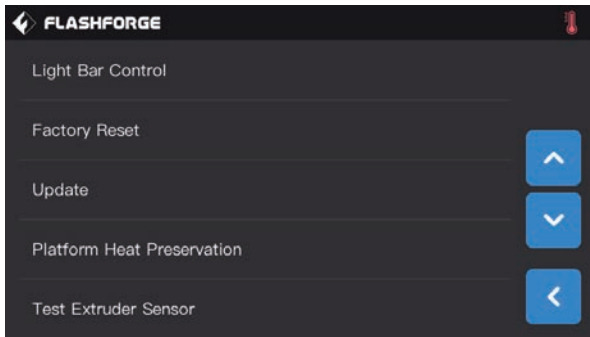

[Setting]-[Platform heat Preservation]

The insulation duration of the platform can be set from 1 to 10 minutes. When the printing finished, the platform will keep heating the current setting time. Reduce the heating time for printing the second model.

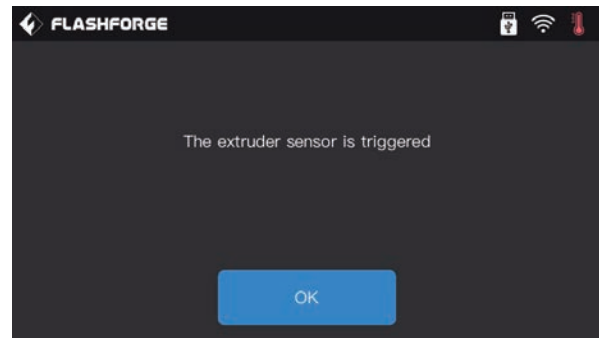
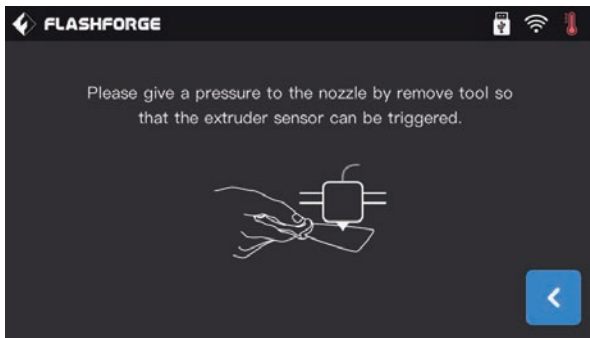
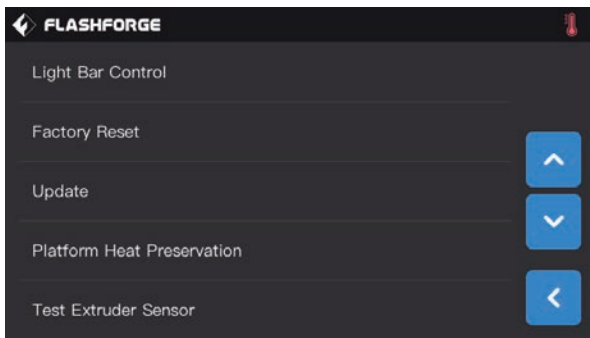

[Setting]-[Test Extruder Sensor]

The detection function of extruder sensor is able to detect whether the sensor is abnormal; If it cannot be triggered, please adjust the sensitivity of the sensor and try again. If it still cannot be triggered, the sensor is damaged, should be changed.

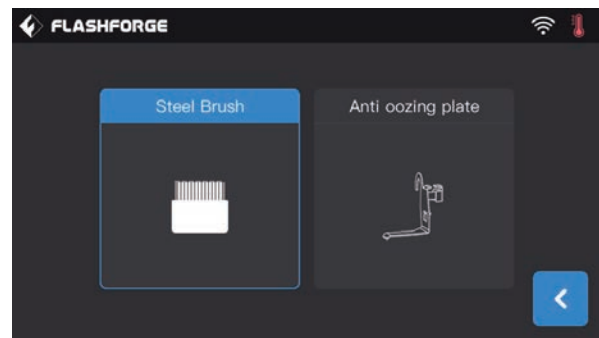
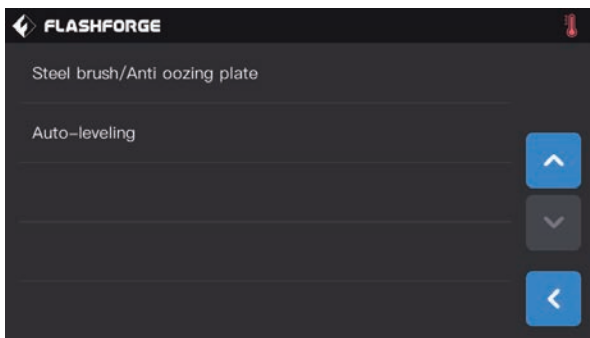

[Setting]-[Steel Brush/Anti oozing plate]

support two type plate.

Steel brush : Extruder moving at Y direction;

Anti oozing plate: A section of filament will be soirt out in advance to avoid the oozinng. The anti-oozing plate is a new option, suggest to use it.

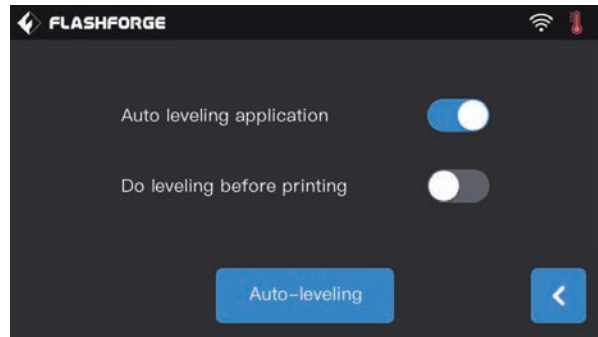
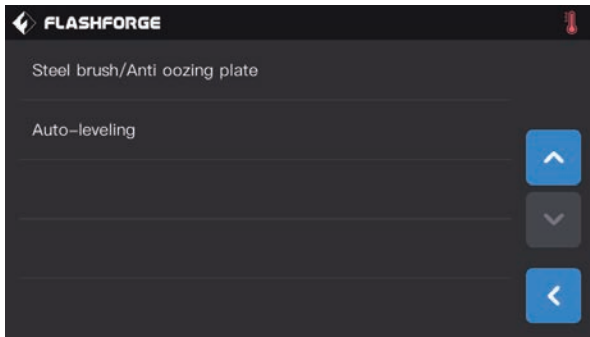

[Setting]-[Auto-leveling]

Auto leveling application: Turn on this function, the compensation value will be application during printing.
 Do leveling before printing: Turn on this function, everytime print it will do the 9 point auto leveling.

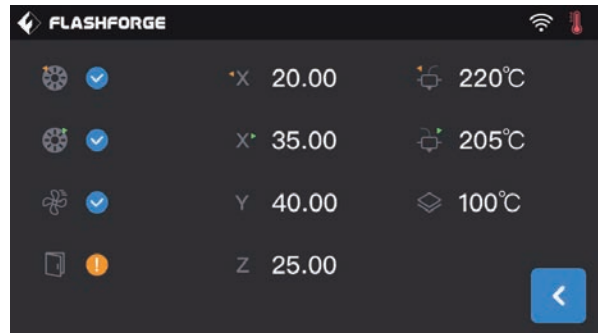
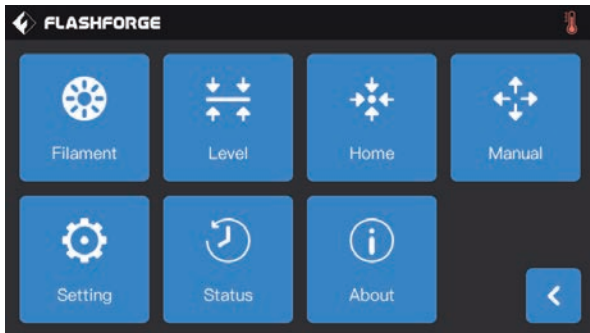

[Tools]-[Status]

Check left/right extruder temperature, platform temperature, filament loaded/unloaded, door opened pause and cooling fan details and extruder XYZ coordinates positions.

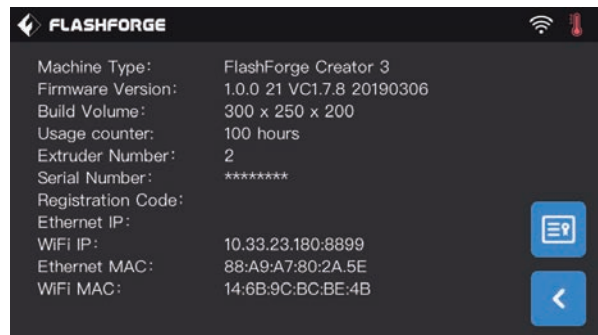
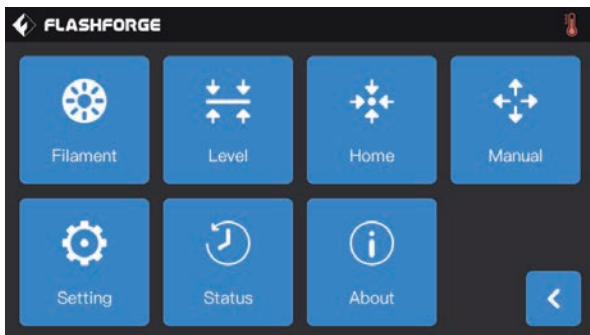



[Tools]-[About]

It displays the basic information about the device. for details shall be subject to the device.
 Note: Please provide the printer serial number to after-sales when your printer need maintenance.

6. Maintenance

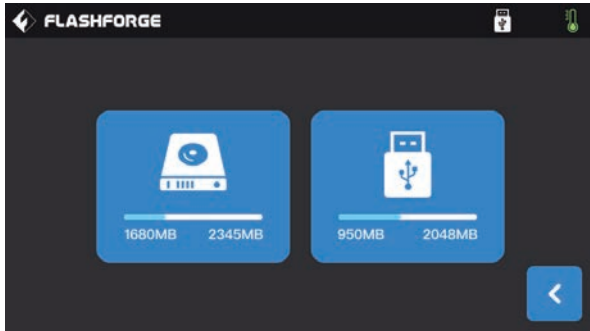
6.1 Log Copy



1. Insert USB stick, you will see  on the top right corner.
2. Tap  wait for 10 seconds, unplug USB stick.
3. Insert USB stick into computer, open USB stick folder to find log files.
4. Send log files to Flashforge customer service.

6.2 Maintenance and Service

Problem	Cause	Corrective Action
Extruder head building off center.	The device has lost track of extruder's exact location and is failing to build.	Send the extruder to the home position will recalibrate Creator 3. Cancel your object, clear build plate, send the extruder to the home position, and restart the object.
PLA is not extruding or sticking to the build tape properly.	This can be caused by the build plate not being leveling with the extruder head.	Leveling the build platform will align the extruder head and ensure a better object quality. Cancel your object, clear build platform, level the build platform, and restart the object.
Creator 3 froze before my object started.	Creator 3 may have received contradictory commands.	Turn power switch off, wait 30 seconds, and turn power switch on.
Spaghetti mess at end of build.	A layer of your object did not stick properly, model was saved with minimal surface area contacting the build platform, or object was built floating above the build platform with no support selected. Z axis offset may not be correct and the extruder tip is not properly spaced with the build platform.	Use the preview feature in your slicing software to see the first layer height and position. Build with supports when necessary. Contact customer service on how to calibrate the Z axis Offset.
Part only built halfway.	Filament ran out. Filament clogged during build.	Replace filament and resume build. See "No filament coming out" .
No filament coming out.	Clogged extruder. Filament not properly loaded.	Contact customer service. Try running a filament change again to ensure the extruder gears have properly caught the filament.
Extruder will not home.	Limit switch wire failure	Contact customer service.
Stringy or fraying plastic layers on steep overhangs.	Object overhangs are too far apart or too steep (Less than 45 degree angle).	Build with supports.

6.3 Extruder Unclogging

1. Tap[Preheat],set heating temperature,then go back.
2. Tap[Tools]-[Filament]-target extruder[loading], wait for extruder to heat up. As filament starts to purge, insert the unclog tool into the extruder intake (top).
3. Clogged debris will be pushed down and will extrude from the extruder tip. You should push the unclog tool all the way down to ensure all filament is purged. You do not need to push with excessive force, as this may damage the extruder.

6.4 Daily Maintenance and Use Suggestion

1. Please cover the top and close the front door to prevent the device from falling into dust when not using the device.If the device has not been used for a long time, it is recommended to use the original packaging.
2. Grease moving parts regularly.For frequent users, add grease at least once every three months;For long-term nonusers, add grease at least every six months.
3. Please clean residue and other sundries in time after printing completed, avoid sundries falling affecting device use.
4. As consumable, build tape may be damaged when adhesive force declined;Please change build tape in time to avoid affecting print effect.
5. Whenever possible, it is best to locate your object in the center of the build platform. Using the best orientation for your object is critical. Ensure that your object is located on the build platform and that you are using the best orientation for building.
6. For steep overhangs (Less than 45 degree angle) it is recommended to build with support.

7. Support and Service

FlashForge team is on standby and ready to help you with any challenges you may have with your Creator 3. If the issues or questions are not covered in this User Guide, you can seek for solutions on our official website or contact us via telephone.

There are solutions and instructions to common issues that can be found in our knowledge base. Have a look first as most basic questions are answered there. <http://www.FlashForge.com>

The FlashForge support team can be reached by e-mail or phone between the working hours of 8:00 a.m. to 5:00 p.m. PST Monday through Saturday. In case you contact us during off-duty time, your inquiry will be answered the following business day.

Note: Because of changing different filament the extruder maybe blockaded. It's not owing to quality issue, and outside the scope of 400 hours life. If users encounter this problem, please contact our after-sale department and finish clean work according to their instruction.

E-mail: flashforge@flashforge.zohodesk.com / support@flashforge.zohodesk.com

ADD: No. 518, Xianyuan Road, Jinhua, Zhejiang

Note: Please provide serial number at the back of the printer before contacting After-sales service.



FCC Warning

This device complies with part 15 of the FCC rules. Operation is subject to the following two conditions: (1) this device may not cause harmful interference, and (2) this device must accept any interference received, including interference that may cause undesired operation.

Changes or modifications not expressly approved by the party responsible for compliance could void the user's authority to operate the equipment.

NOTE: This equipment has been tested and found to comply with the limits for a Class B digital device, pursuant to part 15 of the FCC Rules. These limits are designed to provide reasonable protection against harmful interference in a residential installation. This equipment generates uses and can radiate radio frequency energy and, if not installed and used in accordance with the instructions, may cause harmful interference to radio communications. However, there is no guarantee that interference will not occur in a particular installation. If this equipment does cause harmful interference to radio or television reception, which can be determined by turning the equipment off and on, the user is encouraged to try to correct the interference by one or more of the following measures:

- Reorient or relocate the receiving antenna.
- Increase the separation between the equipment and receiver.
- Connect the equipment into an outlet on a circuit different from that to which the receiver is connected.
- Consult the dealer or an experienced radio/TV technician for help.

Radiation Exposure Statement

This equipment complies with FCC radiation exposure limits set forth for an uncontrolled environment. This equipment should be installed and operated with minimum distance 20cm between the radiator and your body.