



BN Products - USA, LLC.

A Division of Benner-Nawman, Inc. - Wickenburg, AZ

MODEL: BNG4000iD INVERTER GENERATOR OPERATIONS MANUAL



BNG4000iD Operations Manual 072021.i.indd

3450 Sabin Brown Road • Wickenburg, AZ 85390
(800) 992-3833 • mail@bnproducts.com

Thank you

Thank you for choosing our inverter generator.

This manual covers the proper operation and maintenance.

Before operating, please read this manual carefully for important procedures and safety.

All technical data and drawings in this manual are consistent with the information on this product. As a result of revisions and other on going updates, the contents of this manual may be slightly different from the actual product. BN Products reserves the right to make changes at any time, without notice and without incurring any obligation, please understand.

The copyright of this instruction manual belongs to us. No reproduction is allowed without the written consent of BN Products-USA. All rights reserved.

This manual is a permanent part of this generator set and should accompany the generator set if it is resold.



Safety Warning

Personal, product, and property safety of you and others is very important.

Please read carefully the extremely important safety warnings contained in this manual and on the labels of this generator set.

Safety warnings can alert you to potential dangers that may harm you and others.

Please take extra precautions when you read these three symbols: "Danger", "Warning", and "Notice" in front of important safety warnings. Details as below:



If you do not follow the instructions, your life can be in danger or you can be seriously injured.



If you do not follow the instructions, your life can be in danger or you can be seriously injured.



If you do not follow the instructions, you can be injured.

If you do not follow the instructions, your generator set and other property may will be damaged.

1. Safety Instruction

1.1 Safety Specification

Please read and understand this manual before operating. Familiarity with the safe operating procedures of generators can help you avoid accidents.

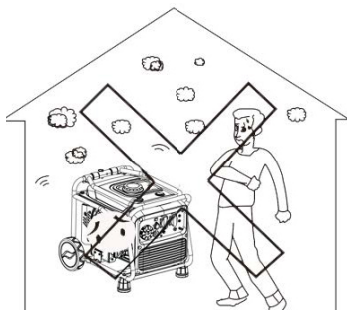

Don't use indoors

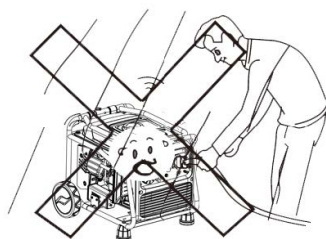

Don't use in a damp environment

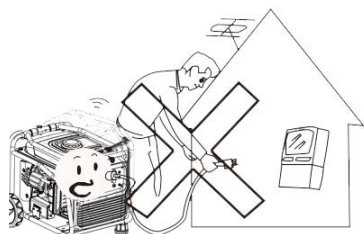

Do not connect directly to household wiring



Don't smoke while adding fuel

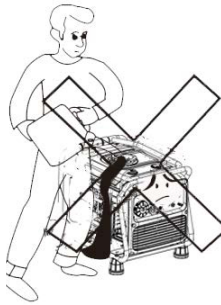

***Do not spill gas
when fueling***



**Stop generator
before fueling**

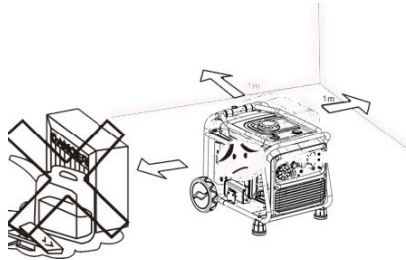

**Please remove combustible
materials at least 4 feet
away from generator**

1.2 Special Request

- Electrical cords and plugs should be in good condition without exposed wires or connections.
- A ground terminal is on this generator and should be connected to a ground wire.
- Extension cords need to be the proper gauge for the distance they have to run.

2. Safety Warning Label

Please read the manual carefully before using.

Safety warning label

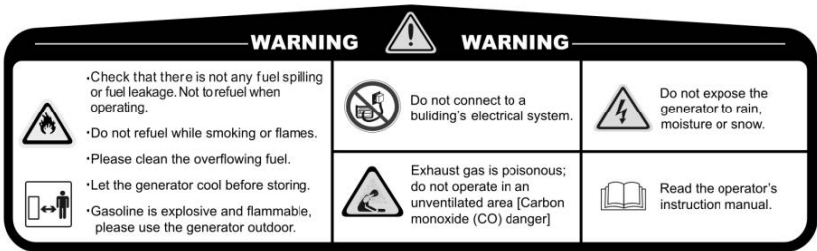

3. Components Identification

3.1 Components Features

BNG4000iD Gas Generator

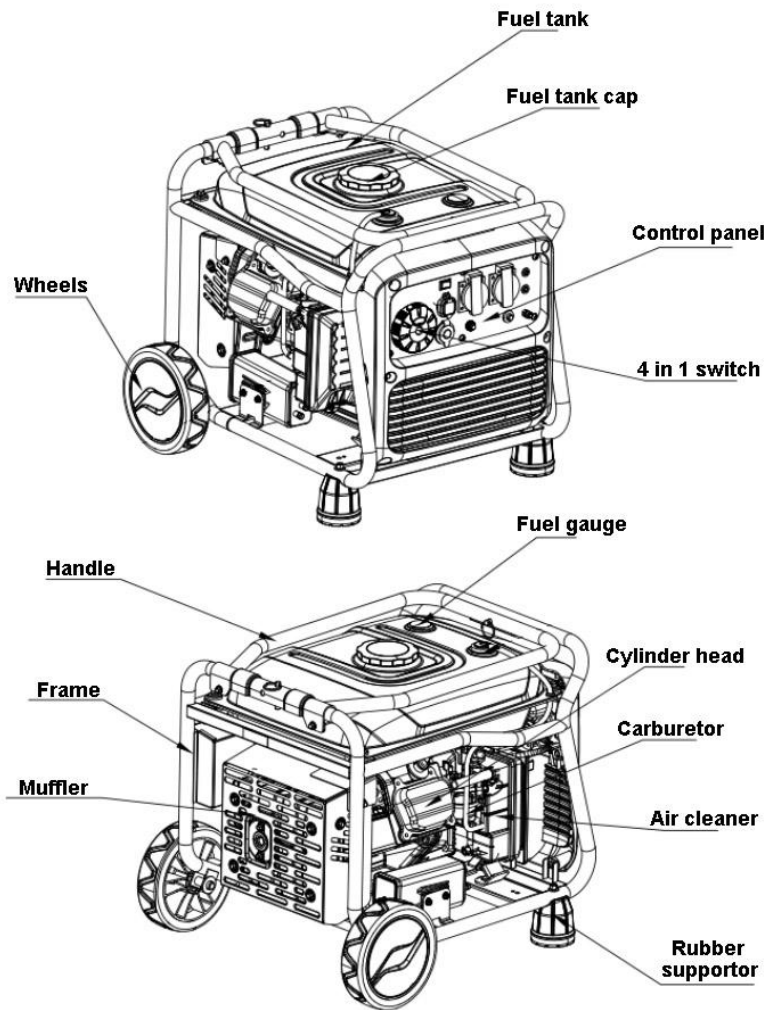

3.2 Control Panel

Factory may adjust the panel for different configurations. Please note that the configuration is subject to change without prior notice.

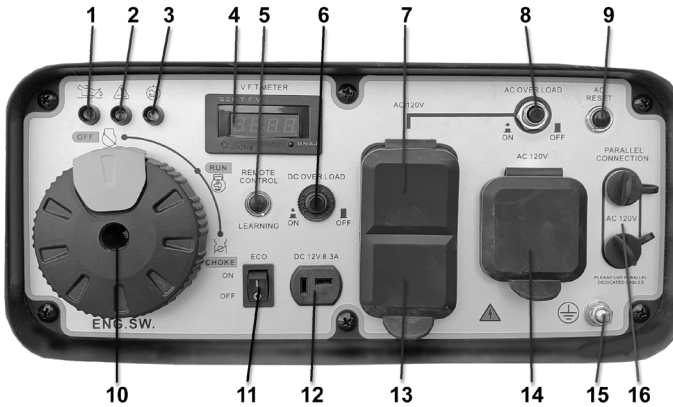

1. Engine oil indicating light
2. Overload indicating light
3. AC indicating light
4. V.F.T. meter
5. Remote Control Learning
6. DC overload reset
7. AC socket
8. AC overload button
9. AC reset
10. 4 in 1 switch
11. ECO (Economy system control)
12. DC plug
13. AC socket
14. 120V three-prong twist lock
15. Ground terminal
16. Parallel socket

3.3 Type and Serial Number

Type and serial number is listed on the side of engine

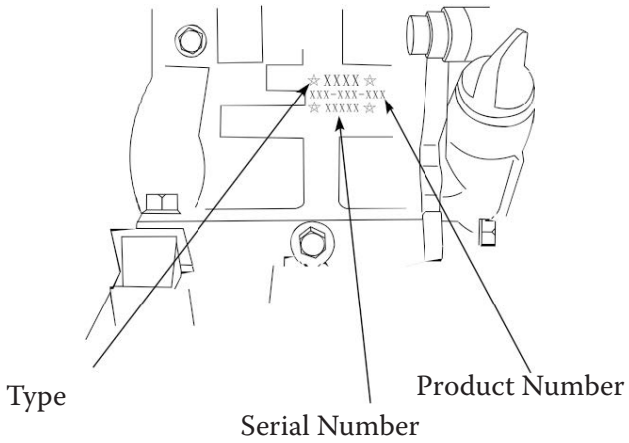

4. Control System

4.1 Engine Oil Alerting System (RED)

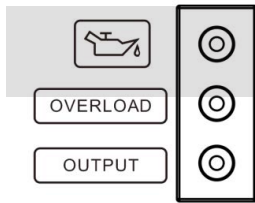

The engine oil protection system will stop the engine automatically, and the engine oil indicating light will light up when the oil in the crankcase is low. Fill the engine oil to the proper level to restart the engine.



If the engine oil alert light flashes for few seconds, it means the oil capacity is insufficient. Refill the oil and restart the engine.

4.2 Overload Indicator Light (RED)

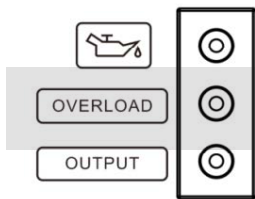

When the overload indicating light is on, the generator detects that the output of the phase-side electrical equipment has been overloaded, causing the converter to overheat or the AC voltage to rise. The AC protector will stop the generator to protect the

generator and the equipment which connects to it. If the AC indicating light (GREEN) is off, but overload indicating light (RED) is on, the engine will continue working. While the overload light is on, and the generator has no output, please take following measures:

1. Disconnect the electrical equipment and stop the engine.
2. Reduce the total power rate of connected electrical equipment within the rated output range.

3. Check the cool air inlet for any blockage and clean the area if needed.

4. Restart the engine after checking.

Notice: When using the electrical equipment with high starting current (like compressors and sink pumps, etc.), the overload indicating light may will flash for few seconds. But this is normal.

4.3 AC Indicator Light (GREEN)

The AC indicator light will be on while the engine starts and has normal output.

4.4 ECO Switch

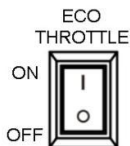

While the ECO switch is in the “ON” position the equipment will control the speed according to the connected load, and will provide good fuel efficiencies and low noise.

When the ECO switch is in the “OFF” position, the engine will run at a rated speed.

NOTICE: For compressors or other heavy loads the switch needs to be set to the “OFF” position for best results.

4.5 Ground Terminal

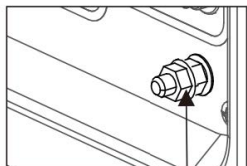

Ground terminal

The ground terminal should be connected to the ground wire to prevent electric shock.

5. Preparation



Please make sure you connect the battery before starting.

5.1 Fuel



- Gasoline is flammable and toxic. Please read the safety instruction carefully before refueling. (See Page 7 for details.)
- Do not fill the tank with too much fuel, or the fuel will overflow when the tank gets warm.
- After refueling, make sure the fuel tank cover is tight.
- Wipe off any spilled gasoline with a clean, soft cloth after refueling.
- You must use unleaded gasoline. Leaded gasoline will damage the internal parts of the engine.
- Suggestion: unleaded gasoline tank capacity: **12.5L or 3.3 gallons.**

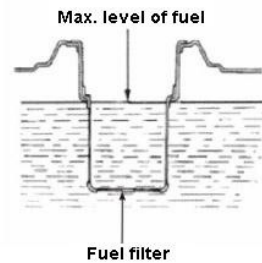
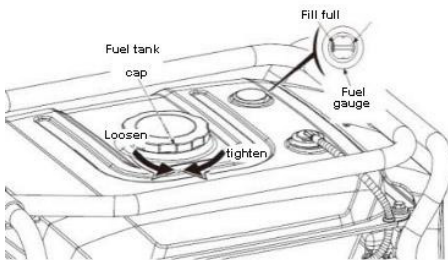

5.2 Engine Oil



The generator is not filled with engine oil when leaving the factory. Please do not start it before filling engine with the required amount of oil.

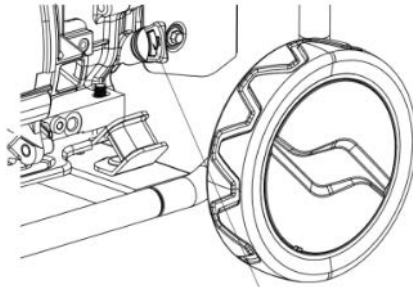

Engine oil
plug and gauge

5.3 Recoil Starter

Pull the starter handle up gently until resistance is felt, then pull it out quickly.



Make sure that the battery is connect before starting the inverter even whe using the pull-start.

! NOTICE

After starting, please do not let the starting handle fly back in-place suddenly, but gently put the handle back.

Recoil starter

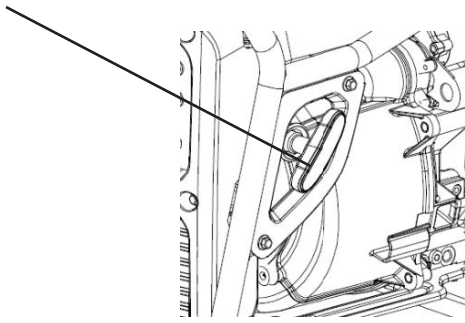

5.4 Fuel Tap

Fuel tap is a device that controls the flow of fuel from the tank to the carburetor. Turn the “4-in-1 switch” to the off position when not in use. This shuts off the gas supply to the carburetor.

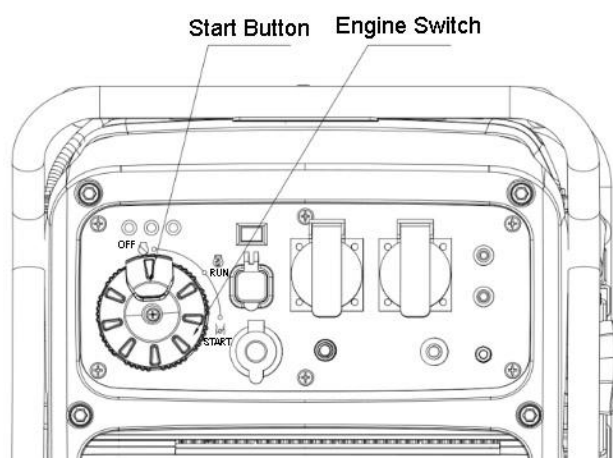

5.5 Choke Valve

Choke valve is used to provide a rich mixture of fuel to a gasoline engine when the cold engine is started. When the cold gasoline engine starts, rotate the knob to the “RUN” position. When the gasoline engine starts up warm, the starting switch can be placed in the “RUN” position to start.

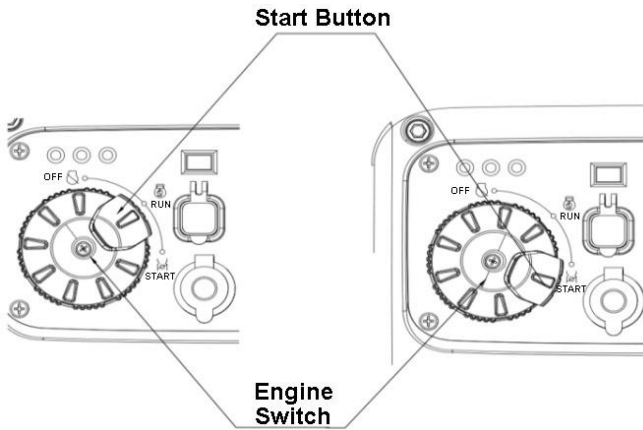

5.6 AC Breaker Protector



Overload current will turn off the breaker protector automatically. The load should be reduced before re-setting the breaker and restarting the generator.

5.7 Ground Terminal



Ground terminal is a special terminal used to ground the entire generator, and to prevent electrical shock.

6. Generator Use

- Applicable temperature: 23° - 104° F (5° - 40° C)
- Applicable humidity: below 95%
- Applicable altitude: below 3300 ft (1000m). Lower power should be expected in areas above this altitude or contact the dealer to adjust the carburetor.

6.1 Connect to House Power Supply

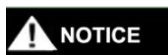

Connecting this generator to a home power supply is not recommended. This type of connection should only be performed by a licensed electrician. Connecting directly to an appliance is acceptable but the generator **MUST** be operated outside of any enclosed space.

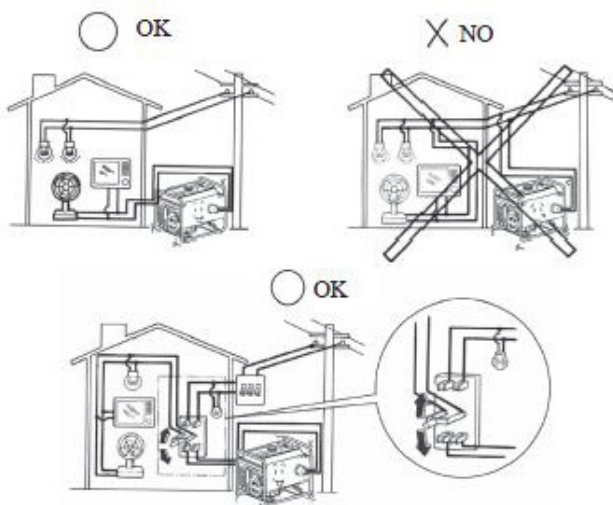

6.2 Generator Grounded



In order to prevent electrical appliances from being damaged by electric shock or the wrong use of electricity, it is recommended to ground the generator with good conductors covered with insulation.

6.3 AC Output







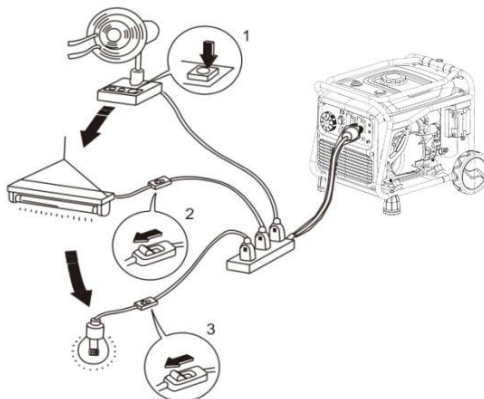

Before starting the generator, please confirm: The total power of the load appliances (the sum of the resistive, capacitive and inductive loads) shall not exceed the rated power of the generator.



Overloading can cause a generator to shut down or significantly shorten its life. If the generator set is connected with several loads or electric equipment, please remember: First switch on the starting load with the highest, then in turn, switch on the starting current with the lowest.



Generally speaking, motors require a large initial starting current. The following table is for your reference when connecting these electrical appliances to the generator set.

Type	Power		Typical Device	Example		
	Max.	Rated		Device	Max.	Rated
<ul style="list-style-type: none"> ● Lamp ● Heating devices 	*1	*1	100W  lamp  TV	100W  lamp	100VA (W)	100VA (W)
<ul style="list-style-type: none"> ● Fluorescent lamp 	*2	*1.5	40W  Fluorescent lamp	40W  Fluorescent lamp	80VA (W)	60VA (W)
<ul style="list-style-type: none"> ● Electrical devices 	*3-5	*2	 Fridge 150W  Fan	150W  Fridge	450-750VA (W)	300VA (W)

5.4 Use in High Altitude Areas

At high altitudes, a standard carburetor will make the gasoline engine mixture too strong, reduce the output power and increase the fuel consumption rate. The performance of a gasoline engine can be improved by modifying the carburetor with a smaller jet nozzle or by the adjusting screw. If you always use the generator at high altitudes above 1000m from sea level, you can take it to one of our authorized dealers to replace or adjust the carburetor. Otherwise, the load power should be reduced when using the generator. Even with the right carburetor, each 300m rise in altitude reduces the power of a gasoline engine by about 3.5%. This decline is even greater if the carburetor has not been adjusted properly.

If the carburetor modified for high-altitude use is then used in low-altitude, the thin mixture will cause the output power of the gasoline engine to drop, overheat and even cause serious damage.

7. Starting the Generator

7.1 Recoil Start

1. Make sure that the battery is connected and remove all loads from the output.
2. Rotate the start switch to put the start button at the “CHOKE” position.
3. Put the “ECO” switch in the OFF position.



If the engine is already hot, move the start button to the “RUN” position

4. Pull the starter handle up gently until you feel resistance and pull it out quickly.
5. When the generator is started, rotate the starting switch to put the starting button in the “RUN” position.

7.2 Electric Start Without Remote

1. Remove all loads from the output.
2. Rotate the start switch to put the start button at the “CHOKE” position.
3. Put the “ECO” switch in the OFF position.



If the engine is already hot, move the start button to the “RUN” position.

4. Press the start button or use the remote start if equipped.



5. Rotate the start switch to put the start button at the “RUN” position if not already there.



Do not crank the motor for more than 5 seconds at a time, otherwise the starting motor will be damaged. If the start is not successful, the interval between starts should be 10 seconds. If the starting motor speed has a noticeable decline, it may indicate that the battery is low and should be removed and charged.

7.3 Electric Start With Remote

1. Turn the start switch (four-in-one knob) to the “Run” position. It is not necessary to set it to the “Choke” position since the remote automatically activates the choke when needed.
2. Press the start button on the remote. The red light on the remote indicates it is working.

7.4 Programming A New Remote

THIS IS EASY. Stand in front of the inverter. Press and hold the “On” button on the remote for 5 or 6 seconds. Release the “On” button and press the “Remote Control-Learning” button on the front of the inverter for 4 seconds. The remote is now set and should start the inverter.

8. Stopping the Generator

1. Rotate the ECO switch to “OFF”.
2. Turn the start button on the four-in-one knob to “OFF”
3. Disconnect all electrical equipment.

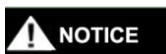

To stop the generator in an emergency, put the generator switch in the “OFF” position.

9. Maintenance

Good maintenance is the best guarantee for a safe, and economical operation, and contribute to environment protection. In order to keep the engine in good condition, you must check and maintain it regularly. Please follow the schedule below.

Item \ Maintenance period		Each use	First month or 20 hrs	Every 3 months or 50 hrs	Every year
Engine oil	Check-Refill	√			
	Replace		√	√	
Gearbox gear oil (if any)	Check oil level	√			
	Replace		√	√	
Air filter element	Check	√			
	Clean		√		
	Replace			√	
Precipitation cup (if any)	Clean				√
Spark plug	Check-Adjust				√*
Spark arrester	Clean		√	√	
Idle (if any)**	Check-Adjust				√
Fuel tank & filter**	Clean				√
Fuel oil line	Check	Every 2 years (Please replace it if necessary.)			
Cylinder head, Piston	Remove carbon deposition**	Displacement < 225cc , every 125 hrs; Displacement ≥ 225cc , every 250 hrs.			
* These items should be replaced if necessary.					
** These items should be maintained by our authorized dealers unless the user has the appropriate tools and repair capacity.					

- The engine oil should be replaced every 10 hours if working frequently at high temperatures or loads.
- The air filter element should be cleaned every 10 hours if operating in a dusty or dirty environment. If necessary, please replace it every 25 hours.

 **NOTICE**

- Spot inspection should be performed before starting.
- If the maintenance cycle time has passed, the maintenance should be carried out as soon as possible according to the maintenance table.

 **WARNING**

Please stop the generator before any maintenance. Place it in a horizontal position. To prevent engine starting, disconnect the spark plug cap from the spark plug. Please do not use it indoors or in places with poor ventilation such as tunnels and caves. Make sure the working area is well ventilated. Exhaust from engines contains the toxic gas carbon monoxide, which can cause shock, loss of consciousness and even death when inhaled.

9.1 Replaceing Engine Oil

Discharging the oil when the engine is warm ensures a quick and clean process.

- Remove the oil gauge. Screw open oil bolt to drain oil.
- Install the drain bolt and tighten it.
- Fill oil and check oil level.
- Reinstall the oil gauge.

Engine oil capacity:
BNG4000iD / BND4000iE is .55 quarts (0.6 L)

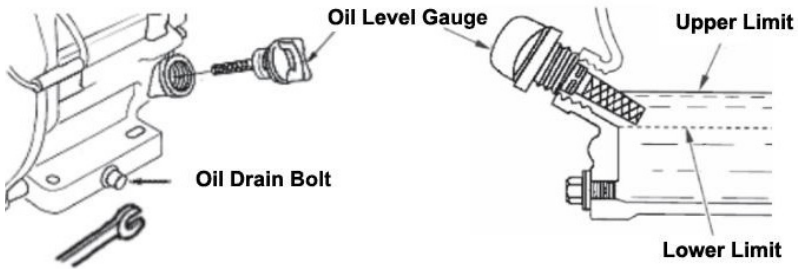

Prolonged and frequent exposure to oil can lead to skin cancer. While this is not a given, it is still recommended that you use soap and water to immediately and thoroughly wash any skin that has been exposed to oil.

From an environmental point of view, please properly handle the waste oil produced. We strongly recommend that you put the oil in a sealed container and take it to your local oil recycling center. Please remember: don't throw it in the trash or dump it on the ground or in a ditch.

9.2 Air Filter Maintenance

Dirty air filters will affect the flow of air into the carburetor. To prevent carburetor breakdown, air filters should be regularly maintained. If it is used in a dusty environment, it should be maintained more frequently.



Cleaning the filter element with gasoline or flammable solvents may cause fire or explosion. Please use soapy water or non-flammable solvent to clean the filter element.

It is strictly forbidden to start the generator without air filter, otherwise it will lead to rapid wear and tear of the gasoline engine.

- Open the latch of the air filter cover and remove the air filter cover. Check the filter element and ensure it's in good condition and clean
- If the foam filter is dirty, please clean it. Wash in hot water with household detergent or in non-flammable or high flash solvent. Then rinse with clean water and squeeze. Then place a few drops of oil and squeeze evenly.
- Install the filter element and replace the air filter cover.

9.3 Spark Plug



Please replace the spark plug with the original type: F7TC

- Remove the spark plug cap.
- Use the spark plug socket wrench to remove the spark plug.
- Visually inspect whether the spark plug insulator is damaged. Replace the spark plug if it is damaged.
- Measure spark plug clearance with thickness gauge. Bend the side electrodes to adjust the clearance. The clearance should be between 0.70 and 0.80mm.
- Check that the spark plug gasket is in good condition.
- Install the spark plug, tighten it with the spark plug socket wrench, and press down the spark plug gasket. Cover the spark plug cap.

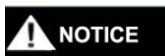

Use only recommended spark plugs

10. Storing

To avoid combustion due to contact with high-temperature components of the generator, the generator must be cooled before packaging and storage. If long-term storage is required, please make sure the storage area is clean and dry.

- Drain fuel from the fuel tank. Clean the fuel filter, O - ring seal and precipitation cup. Unscrew the carburetor drain bolt, drain the fuel from the carburetor entirely, then reinstall and tighten the carburetor drain bolt.
- In ordinary circumstances, gasoline is flammable and explosive. Please drain fuel in well-ventilated area and well away from combustible material and flames.
- Unscrew the oil gauge and Oil drain bolt on the crankcase, and drain the oil in the crankcase. Then tighten the drain bolts, add new oil to the upper limit, and then install the oil gauge.
- Remove the spark plug and pour a tablespoon of clean engine oil into the combustion chamber. Turn the crankshaft several times to distribute the oil. Reinstall the spark plugs.
- Gently pull the starting handle until resistance is felt, leaving the inlet and exhaust valves closed.
- Store the generator set in a clean and dry area.

11. Trouble Shooting

Engine can't be started:

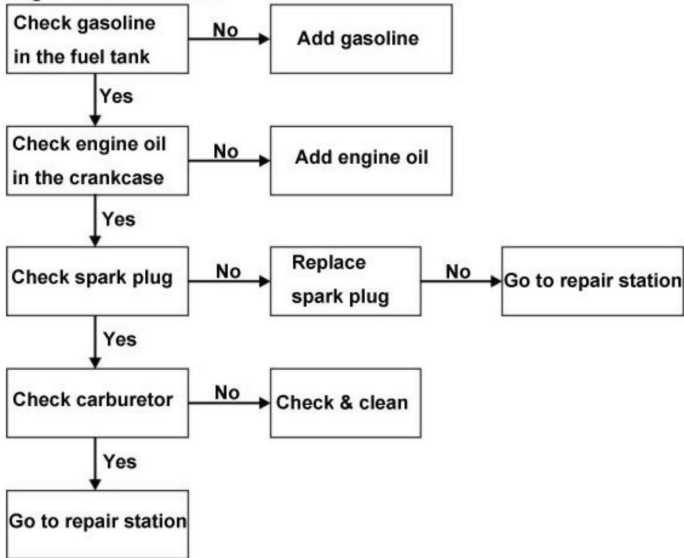

No voltage

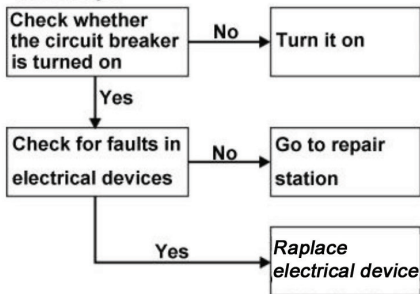

12. Circuit Diagram

The factory can adjust according to the different model configurations, and are subject to change without prior notice.

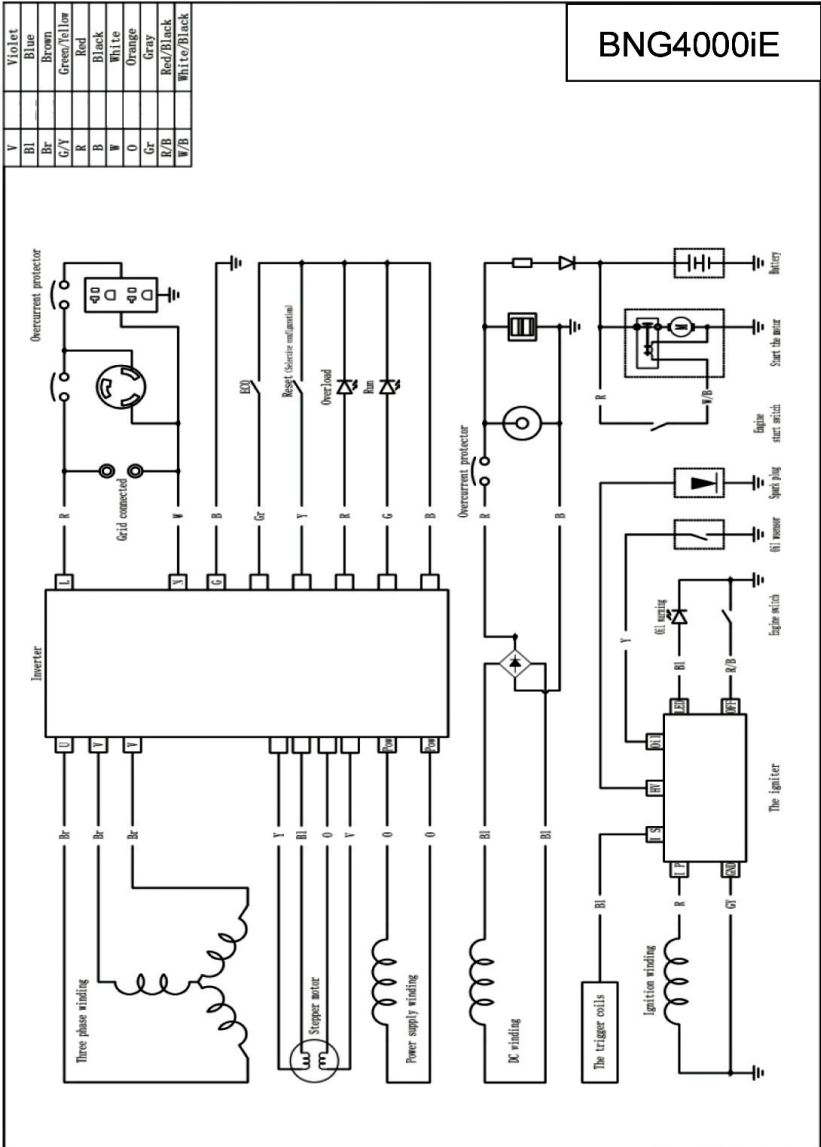

13. Technical Specifications

	Item	BNG4000iD	
Gasoline engine	Engine type	Single head.4-stroke.Air cooling. OHV 25°	
	Displacement(cc)	223	
	Ignition system	C.D.I	
	Starting type	Recoil start	Electric start
	Fuel tank capacity	3.3 Gallons	
	Engine oil	0.55 Quart	
Generator set	Rated frequency (Hz)	60Hz	
	Phase	Single	
	Rated voltage (V)	120V	
	Rated output power(kW)	3.5 kW	
	Max. output power(kW)	4.0kW	
	DC	12V/8.3A	
	Length(mm)	23.5"	
	Width(mm)	11.25"	
Height(mm)	20"		

