



EliteMetalTools.com

281-241-9504

insidesales@elitemetaltools.com

M-F 8:00 AM - 7:30 PM EST

Sharp Industries 440V 10 HP Radial Drill RD-2500

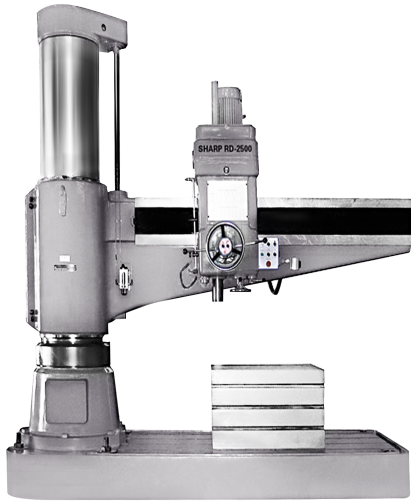

\$216,817.48

As low as \$4,290/mo through Elite Metal Tools financing partners.



FREE SHIPPING



Use your phone to take a picture of this QR Code to learn more!

*Images may display items not included with purchase

Specifications

Manufacturer	Sharp Industries
EMT ID	18856
SKU	RD-2500 (440V)
Shipping Method	Flatbed
Weight	27,500 lb
Dimensions	162 x 73 x 150 in
Country of Origin	Taiwan
Warranty	1 Year (Parts)



- Diameter to Column: 22"
- Head Travel: 79"
- Column to Spindle: 98"
- Motor: 440V, 10 HP

Free Shipping

Free shipping on ALL machines throughout the contiguous United States to all commercial locations.



Product Selection

A wide selection of machinery for you to compare brands and features. Find the right machine for your job.

Knowledgeable Staff

When you have questions, we have the staff that will help you find the answer and equipment that best fits your needs.

Customer Service

Fast and friendly service centered around creating a positive experience.

Price Matching

Our prices are highly competitive. However, if you find an item cheaper somewhere else, we will match that price. Contact us for details.